



Uživatelský návod pro
bezdveřové sprchové systémy
Modular shower







MS 170 L
MS 170 R

Polysan s.r.o
Nesměřice 52
285 22 Zruč nad Sázavou

www.polysan.cz
www.polysan.net

e-mail: info@polysan.net

tel.: +420 327 585 983
fax.: +420 327 585 989

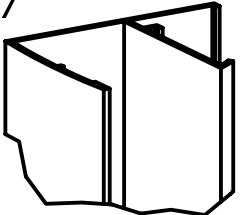
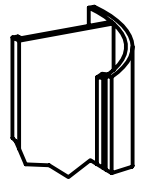
- 1  3x
- 2  6x
- 3  3x
- 4  3x
- 5  1x
- 6  (L+R) 2x
- 7  1x
- 8  1x

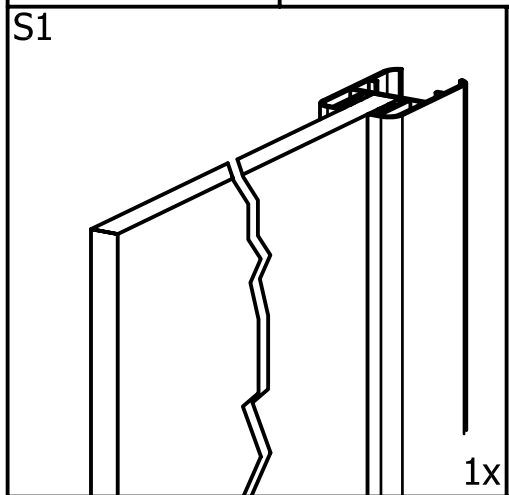
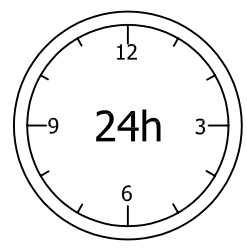
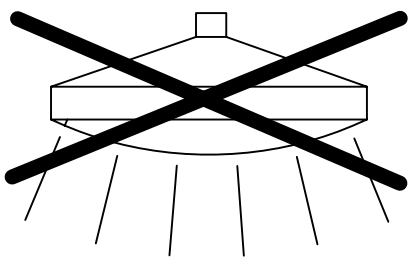
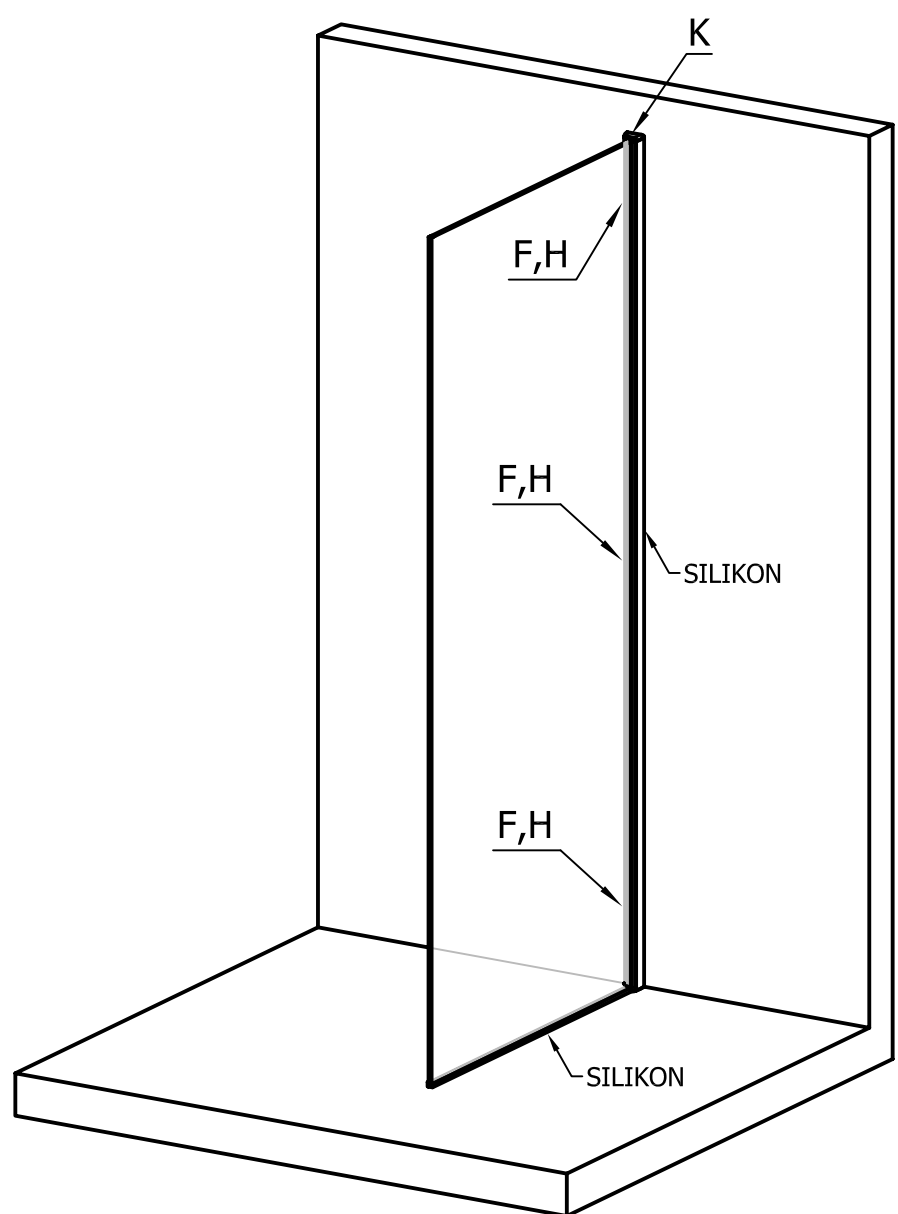

A

S1

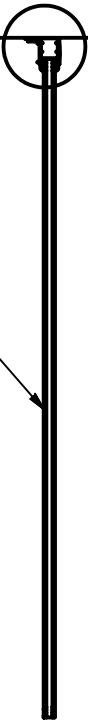

A

