

Raindance E 150 AIR 3jet
28551000

Raindance E 120 AIR 3jet
28549000

Raindance E 100 AIR 3jet
28553000

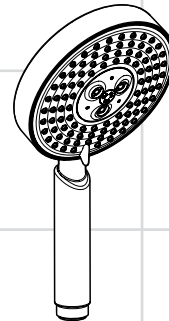

Raindance S 150 AIR 3jet
28550000



Raindance S 120 AIR 3jet
28554000

Raindance S 100 AIR 3jet
28552000

DE	Gebrauchsanleitung / Montageanleitung	2
FR	Mode d'emploi / Instructions de montage	2
EN	Instructions for use / assembly instructions	3
IT	Istruzioni per l'uso / Istruzioni per Installazione	3
ES	Modo de empleo / Instrucciones de montaje	4
NL	Gebruiksaanwijzing / Handleiding	4
DK	Brugsanvisning / Monteringsvejledning	5
PT	Instruções para uso / Manual de Instalação	5
PL	Instrukcja obsługi / Instrukcja montażu	6
CS	Návod k použití / Montážní návod	6
SK	Návod na použitie / Montážny návod	7
ZH	用户手册 / 组装说明	7
RU	Руководство пользователя / Инструкция по монтажу	8
HU	Használati útmutató / Szerelési útmutató	8
FI	Käyttöohje / Asennusohje	9
SV	Bruksanvisning / Monteringsanvisning	9
LT	Vartotojo instrukcija / Montavimo instrukcijos	10
HR	Upute za uporabu / Uputstva za instalaciju	10
TR	Kullanım kılavuzu / Montaj kılavuzu	11
RO	Manual de utilizare / Instrucțiuni de montare	11
EL	Οδηγίες χρήσης / Οδηγία συναρμολόγησης	12
SL	Navodilo za uporabo / Navodila za montažo	12
ET	Kasutusjuhend / Paigaldusjuhend	13
LV	Lietošanas pamācība / Montāžas instrukcija	13
SR	Uputstvo za upotrebu / Uputstvo za montažu	14
NO	Bruksanvisning / Montasjeveiledning	14
BG	Инструкция за употреба / Ръководство за монтаж	15
SQ	Udhëzuesi i përdorimit / Udhëzime rreth montimit	15
AR	دليل الاستخدام / تعليمات التجميع	16



Sicherheitshinweise

-  Bei der Montage müssen zur Vermeidung von Quetsch- und Schnittverletzungen Handschuhe getragen werden.
-  Der Kontakt der Brausestrahlen mit empfindlichen Körperstellen (z. B. Augen) muss vermieden werden. Es muss ein ausreichender Abstand zwischen Brause und Körper eingehalten werden.
-  Die Brause darf nur zur Bade-, Hygiene- und Körperreinigungszwecke eingesetzt werden.



Montagehinweise

- Die der Brause beige packte Siebdichtung muss eingebaut werden, um Schmutzeinspülungen aus dem Leitungsnetz zu vermeiden. Schmutzeinspülungen können die Funktion beeinträchtigen und/oder zu Beschädigungen an Funktionsteilen der Brause führen, für hieraus ergebende Schäden haftet Hansgrohe nicht.

Technische Daten

Betriebsdruck: max. 0,6 MPa
 Empfohlener Betriebsdruck: 0,1 - 0,4 MPa
 (1 MPa = 10 bar = 147 PSI)
 Heißwassertemperatur: max. 60 °C

Consignes de sécurité

-  Lors du montage, porter des gants de protection pour éviter toute blessure par écrasement ou coupure
-  Éviter le contact du jet de la douchette avec les parties sensibles du corps (telles par ex. que les yeux). Veiller à respecter un écart suffisant entre la douchette et le corps
-  La douchette ne doit servir qu'à se doucher, à se nettoyer et à pratiquer une hygiène corporelle.

Instructions pour le montage

- Le joint à filtre fourni avec la pomme de douche à main doit être installé afin de retenir des impuretés du système de conduites. Ceux-ci pourraient influencer le fonctionnement de ce produit et même endommager des pièces mobiles. Des réclamations à la suite de l'usage de la pomme de douche sans joint-tamis de hansgrohe ne peuvent pas faire partie de notre garantie.

Informations techniques

Pression de service autorisée: max. 0,6 MPa
 Pression de service conseillée: 0,1 - 0,4 MPa
 (1 MPa = 10 bar = 147 PSI)
 Température d'eau chaude: max. 60 °C

Symbolerklärung



Maße (siehe Seite 17 - 18)



Durchflussdiagramm
(siehe Seite 17 - 18)



Prüfzeichen (siehe Seite 19)



Bedienung (siehe Seite 20)



Reinigung (siehe Seite 21 - 22) und beiliegende Broschüre



Serviceteile (siehe Seite 23)

Description du symbole



Dimensions (voir page 17 - 18)



Diagramme du débit
(voir pages 17 - 18)



Classification acoustique et débit (voir pages 19)



Instructions de service (voir page 20)



Nettoyage (voir pages 21 - 22) et brochure ci-jointe





Pièces détachées (voir pages 23)





Safety Notes

-  Gloves should be worn during installation to prevent crushing and cutting injuries.
-  Do not allow the streams of the shower touch sensitive body parts (such as your eyes). An adequate distance must be kept between the shower and you.
-  The shower may only be used for bathing, hygiene and body cleansing purposes.

Installation Instructions

- The mesh washer must be insert to protect the overhead shower against incoming dirt by pipework. Incoming dirt leads to defects or/and can damage parts of the shower; such caused faults voids all liability and guarantee claims.

Technical Data

Operating pressure:	max. 0,6 MPa
Recommended operating pressure: (1 MPa = 10 bar = 147 PSI)	0,1 - 0,4 MPa
Hot water temperature:	max. 60°C

Symbol description



Dimensions (see page 17 - 18)



Flow diagram (see page 17 - 18)



Test certificate (see page 19)



Operation (see page 20)





Cleaning (see page 21 - 22) enclosed brochure



Spare parts (see page 23)

Indicazioni sulla sicurezza

-  Durante il montaggio, per evitare ferite da schiacciamento e da taglio bisogna indossare guanti protettivi.
-  Bisogna evitare il contatto fra il getto della doccia e parti del corpo delicate (ad es. gli occhi). Fra il soffione ed il corpo va mantenuta una distanza sufficiente.
-  La doccia deve essere impiegata solo per il bagno e utilizzo igienico e pulizia del corpo.

Istruzioni per il montaggio

- Per proteggere la soffione doccia da eventuali impurità provenienti dalle tubazioni dell'acqua, deve essere inserito il filtro nell'impugnatura della doccia stessa. Tali impurità possono infatti causare difetti e/o danneggiare parti della doccia; in questo caso la Hansgrohe non risponde dei danni.

Dati tecnici

Pressione d'uso:	max. 0,6 MPa
Pressione d'uso consigliata: (1 MPa = 10 bar = 147 PSI)	0,1 - 0,4 MPa
Temperatura dell'acqua calda:	max. 60°C

Descrizione simbolo



Ingombri (vedi pagg. 17 - 18)



Diagramma flusso (vedi pagg. 17 - 18)



Segno di verifica (vedi pagg. 19)



Procedura (vedi pagg. 20)



Pulitura (vedi pagg. 21 - 22) e brochure allegata



Parti di ricambio (vedi pagg. 23)

Assembly
see page 19



Montaggio
vedi pagg. 19



Indicaciones de seguridad

- ⚠ Durante el montaje deben utilizarse guantes para evitar heridas por aplastamiento o corte.
- ⚠ Debe evitarse el contacto del chorro del pulverizador con partes sensibles del cuerpo (por ej. ojos). Debe mantenerse una distancia suficiente entre pulverizador y cuerpo.
- ⚠ La roseta de ducha solo debe utilizarse para fines de baño, higiene y limpieza corporal.

Indicaciones para el montaje

- La junta de filtración que se suministra con la ducha mural evita que las partículas de suciedad procedentes de las tuberías lleguen a la ducha mural. Debe colocarse entre el flexo y la ducha mural. Infiltraciones de suciedad deterioran el funcionamiento de la ducha mural y pueden causar daños en el interior de la misma que no están cubiertas por la garantía de Hansgrohe.

Datos técnicos

Presión en servicio:	max. 0,6 MPa
Presión recomendada en servicio: (1 MPa = 10 bar = 147 PSI)	0,1 - 0,4 MPa
Temperatura del agua caliente:	max. 60°C

Veiligheidsinstructies

- ⚠ Bij de montage moeten ter voorkoming van kniel- en snijwonden handschoenen worden gedragen.
- ⚠ Het contact van de douchestraal met gevoelige lichaamsdelen (bijv. ogen) moet worden voorkomen. Er moet voldoende afstand tussen douche en lichaam aangehouden worden.
- ⚠ De douche uitsluitend toepassen in badkamers ten behoeve van lichaamsreiniging.

Montage-instructies

- Het bij de hoofddouche verpakte zeefje moet worden ingebouwd om vuil uit de waterleiding te weren. Vuil uit de leidingen kan de werking van de hoofddouche negatief beïnvloeden en/of de hoofddouche beschadigen. Voor deze schade is Hansgrohe niet verantwoordelijk.

Technische gegevens

Werkdruk: max.	max. 0,6 MPa
Aanbevolen werkdruk: (1 MPa = 10 bar = 147 PSI)	0,1 - 0,4 MPa
Temperatuur warm water:	max. 60°C

Descripción de símbolos



Dimensiones (ver página 17 - 18)



Diagrama de circulación (ver página 17 - 18)



Marca de verificación (ver página 19)



Manejo (ver página 20)



Limpiar (ver página 21 - 22) y folleto anexo



Repuestos (ver página 23)

Symboolbeschrijving



Maten (zie blz. 17 - 18)



Doorstroombiagram (zie blz. 17 - 18)



Keurmerk (zie blz. 19)



Bediening (zie blz. 20)



Reinigen (zie blz. 21 - 22) en bijgevoegde brochure





Service onderdelen (zie blz. 23)





Sikkerhedsanvisninger

-  Ved monteringen skal der bruges handsker for at undgå kvæstelser og snitsår.
-  Bruserstrålens kontakt med sensitive områder (f.eks. øjne) skal undgås. Der skal være en tilstrækkelig afstand mellem bruseren og kroppen.
-  Bruseren må kun bruges til at bruse, til hygiejne og rengøring af kroppen.

Monteringsanvisninger

- Den vedlagte smudsfangssi skal indsættes i bruseren for at undgå snavs fra rørsystemet. Indskyllet snavs kan have indflydelse på bruserens funktion og/eller føre til beskadigelser på håndbruserens funktionsdele.

Tekniske data

Driftstryk:	max. 0,6 MPa
Anbefalet driftstryk:	0,1 - 0,4 MPa
(1 MPa = 10 bar = 147 PSI)	
Varmtvandstemperatur:	max. 60°C

Symbolbeskrivelse



Målene (se s. 17 - 18)



Doorstroombiagram (se s. 17 - 18)



Godkendelse (se s. 19)



Brugsanvisning (se s. 20)





Rengøring (se s. 21 - 22) og vedlagt brochure



Reserve dele (se s. 23)

Avisos de segurança

-  Durante a montagem devem ser utilizadas luvas de protecção, de modo a evitar ferimentos resultantes de entalamentos e de cortes.
-  Deve-se evitar o contacto dos jactos de água com partes do corpo sensíveis (p. ex. olhos). É necessário manter uma distância suficiente entre o chuveiro e o corpo.
-  O chuveiro só pode ser utilizado para fins de higiene pessoal.

Avisos de montagem

- O filtro de rede deve ser colocado para proteger o chuveiro de areias e resíduos provenientes da tubagem. Resíduos e areias podem danificar componentes, ou provocar mau funcionamento do chuveiro; as avarias assim provocadas anulam a nossa responsabilidade e anulam a nossa garantia.

Dados Técnicos

Pressão de funcionamento:	max. 0,6 MPa
Pressão de func. recomendada:	0,1 - 0,4 MPa
(1 MPa = 10 bar = 147 PSI)	
Temperatura da água quente:	max. 60°C

Descrição do símbolo



Medidas (ver página 17 - 18)



Fluxograma (ver página 17 - 18)



Marca de controlo
(ver página 19)



Funcionamento (ver página 20)



Limpeza (ver página 21 - 22) e brochura em anexo





Peças de substituição
(ver página 23)





Wskazówki bezpieczeństwa

-  Aby uniknąć zranień, takich jak zgniecenia czy przecięcia, podczas montażu należy nosić rękawice.
-  Należy unikać kontaktu strumienia wypywającego z głowicy z wrażliwymi częściami ciała (np. oczami). Należy zachowywać odpowiednią odległość pomiędzy głowicą a ciałem.
-  Prysznic może być używany tylko do kąpieli, higieny i czyszczenia ciała.

Wskazówki montażowe

- Znajdujące się przy prysznicu sitko musi zostać zainstalowane, aby zatrzymać zanieczyszczenia z instalacji. Przedostające się zanieczyszczenia mogą mieć ujemny wpływ na działanie i/lub prowadzić do usterek w działaniu elementów prysznic. Za powstanie z tego tytułu szkody firma Hansgrohe nie ponosi odpowiedzialności.

Dane techniczne

Ciśnienie robocze:	maks. 0,6 MPa
Zalecane ciśnienie robocze: (1 MPa = 10 bary = 147 PSI)	0,1 - 0,4 MPa
Temperatura wody gorącej:	maks. 60°C

Opis symbolu



Wymiary (patrz strona 17 - 18)



Schemat przepływu
(patrz strona 17 - 18)



Znak jakości (patrz strona 19)



Obsługa (patrz strona 20)





Czyszczenie (patrz strona 21 - 22) i dołączona broszura



Części serwisowe
(patrz strona 23)

Bezpečnostní pokyny

-  Pro zabránění řezným zraněním a pohmožděním je nutné při montáži nosit rukavice.
-  Je nutné zabránit kontaktu vodních paprsků sprchy s měkkými částmi těla (např. očima). Je nutné dodržovat dostatečný odstup mezi sprchou a tělem.
-  Sprcha smí být používána pouze za účelem koupání a tělesné hygieny.

Pokyny k montáži

- Do přívodu musí být zabudováno se sprchou dodávané sítko, aby zachycovalo nečistoty vyplavené z vodovodní sítě. Vyplavené nečistoty mohou ovlivnit funkci sprchy a nebo mohou vést i k jejímu poškození. Na takto vzniklé škody se nevztahuje záruka firmy Hansgrohe.

Technické údaje

Provozní tlak:	max. 0,6 MPa
Doporučený provozní tlak: (1 MPa = 10 bar = 147 PSI)	0,1 - 0,4 MPa
Teplota horké vody:	max. 60°C

Popis symbolů



Rozměry (viz strana 17 - 18)



Diagram průtoku (viz strana 17 - 18)



Zkušební značka (viz strana 19)



Ovládání (viz strana 20)



Čištění (viz strana 21 - 22) a přiložená brožura





Servisní díly (viz strana 23)





Bezpečnostné pokyny

-  Pri montáži musíte nosiť rukavice, aby ste predišli pomliaždeninám a rezným poraneniam.
-  Vyhýbajte sa kontaktu vodného lúča sprchy s citlivými miestami tela (napr. oči). Dodržiavajte dostatočnú vzdialenosť medzi sprchou a telom.
-  Sprcha sa smie používať len na účely kúpania a telesnej hygieny.

Pokyny pre montáž

- Do prívodu musí byť zabudované so sprchou dodávané sítko, aby zachytilo nečistoty vyplavené z vodovodnej siete. Vyplavené nečistoty môžu ovplyvniť funkciu sprchy, alebo spôsobiť jej poškodenie. Na takto vzniknuté škody sa nevzťahuje záruka firmy Hansgrohe.

Technické údaje

Prevádzkový tlak:	max. 0,6 MPa
Doporučený prevádzkový tlak: (1 MPa = 10 bar = 147 PSI)	0,1 - 0,4 MPa
Teplota teplej vody:	max. 60°C

Popis symbolov

 **Rozmery** (viď strana 17 - 18)

 **Diagram prietoku** (viď strana 17 - 18)





 **Osvedčenie o skúške**
(viď strana 19)

 **Obsluha** (viď strana 20)

 **Čistenie** (viď strana 21 - 22) a priložená brožúra

 **Servisné diely** (viď strana 23)

安全技巧

-  装配时为避免挤压和切割受伤，必须戴上手套。
-  必须避免让身体敏感部位（如眼睛）接触到莲蓬头喷水。必须保持莲蓬头与人头之间有足够的距离。
-  该莲蓬头仅允许作淋浴、卫生保健和身体清洁目的使用。

安装提示

- 必须装上花洒所附带的滤网密封垫，以过滤管道里的杂质污物。杂质污物会影响花洒的功能和/或损坏花洒的功能部件，由此而产生的产品损坏不属于汉斯格雅的保修范围。

技术参数

工作压力:	最大 0,6 MPa
推荐工作压力: (1 MPa = 10 bar = 147 PSI)	0,1 - 0,4 MPa
热水温度:	最大 60° C

符号说明

 大小 (参见第 17 - 18 页)

 流量示意图 (参见第页 17 - 18)



 检验标记 (参见第页 19)

 操作 (参见第 20 页)

 清洗 (参见第页 21 - 22) 并附有小手册

 备用零件 (参见第 23 页)

Montáž
viď strana 19



安装
参见第页 19



Указания по технике безопасности

- Во время монтажа следует надеть перчатки во избежание прищемления и порезов.
- Не допускайте попадания струи воды из разбрызгивателя на чувствительные части тела (например, на глаза). Разбрызгиватель следует устанавливать на достаточном расстоянии от тела.
- Источник разбрызгивания разрешается использовать только в гигиенических целях для принятия ванны и личной гигиены.

Указания по монтажу

- Для предотвращения попадания частиц грязи из водопроводной сети необходимо установить фильтр, прилагаемый к ручному душу. Частицы грязи могут нарушить отдельные функции и/или привести к повреждению функциональных деталей ручного душа, Hansgrohe не несет ответственность за повреждения вследствие отсутствия фильтра.

Технические данные

Рабочее давление:	не более 0,6 МПа
Рекомендуемое рабочее давление:	0,1 - 0,4 МПа
(1 МПа = 10 bar = 147 PSI)	
Температура горячей воды:	не более 60 °C

Описание символов



Размеры (см. стр. 17 - 18)



Схема потока (см. стр. 17 - 18)



Знак технического контроля
(см. стр. 19)



Эксплуатация (см. стр. 20)



Очистка (см. стр. 21 - 22) и прилагаемая брошюра



Комплект (см. стр. 23)

Biztonsági utasítások

- A szerelésnél a zúzódások és vágási sérülések elkerülése érdekében kesztyűt kell viselni.
- Kerülni kell a zuhanyugár érintkezését érzékeny testrészekkel (pl. szemek). Be kell tartani a megfelelő távolságot a zuhanyfej és a test között.
- A zuhanyt csak fürdő-higiéniai- és tisztítási célra szabad használni.

Szerelési utasítások

- A kézi zuhanyhoz csomagolt szűrőtömítést be kell szerelni a vízhálózatból származó szennyeződések kiküszöbölésére. A beáramló szennyeződések akadályozhatják és / vagy teljesen tönkre is tehetik a zuhany funkcióit. Az ezekből adódó károkért a Hansgrohe nem felel.

Műszaki adatok

Üzemi nyomás:	max. 0,6 MPa
Ajánlott üzemi nyomás:	0,1 - 0,4 MPa
(1 MPa = 10 bar = 147 PSI)	
Forróvíz hőmérséklet:	max. 60 °C

Szimbólumok leírása



Méretet (lásd a 17 - 18. oldalon)



Átfolyási diagramm
(lásd az oldalon 17 - 18)



Vizsgajel (lásd az oldalon 19)



Használat (lásd a 20. oldalon)



Tisztítás (lásd az oldalon 21 - 22) és mellékelt brosúrával





Tartozékok (lásd a 23. oldalon)





Turvallisuusohjeet

-  Asennuksessa on käytettävä käsineitä puristumien ja viiltojen aiheuttamien tapaturmien estämiseksi.
-  Suihkuveden kontaktia herkkien ruumiinosien (esim. silmien) kanssa on vältettävä. Suihkuun ja vartalon välissä on oltava riittävä väli.
-  Suihkua saa käyttää vain kylpy-, hygieniä ja kehonpuhdistustarkoituksiin.



Asennusohjeet

- Käsिसuihkuun mukana toimitettu sihtitiiviste on asennettava paikalleen, jotta lian huuhtoutuminen vesijohtoverkostosta käsisisuihkuun estyy. Huuhtoutuvat likahiukkaset voivat häiritä suihkun toimintaa tai vahingoittaa toimintaosia, Hansgrohe ei vastaa tästä aiheutuneista vahingoista.

Tekniset tiedot

Käyttöpain:	maks. 0,6 MPa
Suosittelut käyttöpain:	0,1 - 0,4 MPa
(1 MPa = 10 bar = 147 PSI)	
Kuuman veden lämpötila:	maks. 60°C

Säkerhetsanvisningar

-  Handskar ska bäras under monteringsarbetet så att man kan undvika kläm- och skärskadorgen werden.
-  Undvik att rikta duschstrålarna mot känsliga kroppsdelar (t. ex. ögonen). Det måste finnas ett tillräckligt stort avstånd mellan duschen och kroppen.
-  Duschen får bar användas till dusch-, bad- och personlig hygien.

Monteringsanvisningar

- Silpackningen som följer med duschen måste monteras för att undvika att smuts från ledningsnätet tränger in. Smuts som spolans in kan påverka funktionerna och/eller leda till skador på funktionsdelar i duschen. Hansgrohe fränsäger sig allt ansvar för skador som kan härledas till detta.

Tekniska data

Driftstryck:	max. 0,6 MPa
Rek. driftstryck:	0,1 - 0,4 MPa
(1 MPa = 10 bar = 147 PSI)	
Varmvattentemperatur:	max. 60°C

Merkin kuvaus



Mitat (katso sivu 17 - 18)



Virtausdiagrammi
(katso sivu 17 - 18)



Koestusmerkki (katso sivu 19)



Käyttö (katso sivu 20)



Puhdistus (katso sivu 21 - 22) ja oheinen esite



Varaosat (katso sivu 23)

Simbolio aprašymas



Måtten (se sidan 17 - 18)



Pralaidumo diagrama
(se sidan 17 - 18)



Testsigill (se sidan 19)



Hantering (se sidan 20)



Rengöring (se sidan 21 - 22) och medföljande broschyr



Reservdelar (se sidan 23)



Asennus
katso sivu 19



Montering
se sidan 19



Saugumo technikos nurodymai

-  Apsaugai nuo užspaudimo ir įsijovimo montavimo metu mūvėkite pirštines.
-  Būtina vengti dušo vandens srovės kontakto su jautriomis kūno vietomis (pvz., akimis). Todėl būtina laikytis tinkamo atstumo nuo dušo.
-  Dušo galva naudojama tik maudymosi, higieniniais ir kūno švarinimo tikslais.



Montavimo instrukcija

- Tinklelis, kuris yra rankų dušas pakuotėje, privalo būti įstatytas, kad būtų apsaugota nuo išorės nešvarumų. Nešvarumai gali pakenkti rankų dušas funkcionalumui ir (arba) sugadinti rankų dušas funkcines dalis. Tokiu atveju „Hansgrohe“ atsakomybės nepriima.

Techniniai duomenys

Darbinis slėgis: ne daugiau kaip 0,6 MPa
 Rekomenduojamas slėgis: 0,1 - 0,4 MPa
 (1 MPa = 10 barų = 147 PSI)
 Karšto vandens temperatūra: ne daugiau kaip 60°C

Sigurnosne upute

-  Prilikom montaže se radi sprječavanja prignječenja i posjekotina moraju nositi rukavice.
-  Mora se izbjegavati kontakt mlaza iz tuša s osjetljivim dijelovima tijela (npr. očima). Tijelo korisnika mora biti dovoljno udaljeno od tuša.
-  Tuš se smije primjenjivati samo za kupanje, tuširanje i osobnu higijenu.

Upute za montažu

- Filter potrebno je ugraditi kako bi se regulirao protok vode i smanjio dotok prljavštine. Za eventualna oštećenja uzrokovana prljavštinom proizvođač Hansgrohe nije odgovoran.

Tehnički podatci

Najveći dopušteni tlak: tlak 0,6 MPa
 Preporučeni tlak: 0,1 - 0,4 MPa
 (1 MPa = 10 bar = 147 PSI)
 Temperatura vruće vode: tlak 60°C

Simbolio aprašymas

 **Išmatavimai** (žr. psl. 17 - 18)



Pralaidumo diagrama
(žr. psl. 17 - 18)



Bandymo pažyma (žr. psl. 19)



Eksploatacija (žr. psl. 20)



Valymas (žr. psl. 21 - 22) ir pridodama brošiūra



Atsarginės dalys (žr. psl. 23)

Opis simbola

 **Mjere** (pogledaj stranicu 17 - 18)



Dijagram protoka
(pogledaj stranicu 17 - 18)



Oznaka testiranja
(pogledaj stranicu 19)



Upotreba (pogledaj stranicu 20)



Čišćenje (pogledaj stranicu 21 - 22) i priložena brošura



Rezervni djelovi
(pogledaj stranicu 23)

Montavimas
žr. psl. 19



Sastavljanje
pogledaj stranicu 19



! Güvenlik uyarıları

- ⚠ Montaj esnasında ezilme ve kesilme gibi yaralanmaları önlemek için eldiven kullanılmalıdır.
- ⚠ Püskürtme başlıklarının hassas organlara teması (örn. gözler) önlenmelidir. Püskürtücü ile beden arasında yeterli mesafe bırakılmalıdır.
- ⚠ Su püskürtücü yalnızca banyo, hijyen ve yıkanma amaçları için kullanılabilir.

Montaj açıklamaları

- El duşu kafasına eklenmiş olan süzgeç contası, boru şebekesinden sızan kirlerin önüne geçmek için, yerine monte edilmelidir. İçeri sızan bu kirler duşun fonksiyonunu sekteleyebilir ve/veya duşun fonksiyon parçaları üzerinde hasarlara sebep olabilir, bu yüzden meydana gelen hasarlardan Hansgrohe sorumlu tutulamaz.

Teknik bilgiler

İşletme basıncı:	azami 0,6 MPa
Tavsiye edilen işletme basıncı:	0,1 - 0,4 MPa
(1 MPa = 10 bar = 147 PSI)	
Sıcak su sıcaklığı:	azami 60°C

! Instrucțiuni de siguranță

- ⚠ La montare utilizați mânășii pentru evitarea contuziunilor și tăierii mâinilor.
- ⚠ Evitați contactul jetului de apă cu părțile de corp sensibile (de ex. ochii). Țineți dușul la o distanță corespunzătoare de corp.
- ⚠ Dușul poate fi utilizat doar în scopuri de spălare, igienizare și de întreținere a igienei corporale.

Instrucțiuni de montare

- Montați garnitura de filtru livrată împreună cu capătul de duș de mână pentru evitarea pătrunderii impurităților din rețeaua de alimentare. Impuritățile pătrunse pot influența funcționarea aparatului și/sau provoca deteriorarea capătului de duș. Garanția nu acoperă aceste daune.

Date tehnice

Presiune de funcționare:	max. 0,6 MPa
Presiune de funcționare recomandată:	0,1 - 0,4 MPa
(1 MPa = 10 bar = 147 PSI)	
Temperatura apei calde:	max. 60°C

Simge açıklaması

 **Ölçüleri** (Bakınız sayfa 17 - 18)



Akış diyagramı (Bakınız sayfa 17 - 18)



Kontrol işareti (Bakınız sayfa 19)



Kullanımı (Bakınız sayfa 20)



Temizleme (Bakınız sayfa 21 - 22) ve birlikte verilen broşür



Yedek Parçalar (Bakınız sayfa 23)

Descrierea simbolurilor

 **Dimensiuni** (vezi pag. 17 - 18)



Diagrama de debit (vezi pag. 17 - 18)



Certificat de testare (vezi pag. 19)



Utilizare (vezi pag. 20)



Curățare (vezi pag. 21 - 22) și broșura alăturată



Piese de schimb (vezi pag. 23)

Montajı
Bakınız sayfa 19



Montare
vezi pag. 19



Υποδειξεις ασφαλείας

- ⚠ Για να αποφύγετε τραυματισμούς κατά τη συναρμολόγηση πρέπει να φοράτε γάντια.
- ⚠ Η επαφή δέσμης νερού του ντους με ευαίσθητες περιοχές του σώματος (π.χ. μάτια) πρέπει να αποφεύγεται. Διατηρείτε επαρκή απόσταση ανάμεσα στο ντους και το σώμα.
- ⚠ Το ντους επιτρέπεται να χρησιμοποιείται μόνο για το μπάνιο, τον καθαρισμό και την υγιεινή του σώματος.

Οδηγίες συναρμολόγησης

- Πρέπει να εγκατασταθεί το παρέμβυσμα φίλτρου που συνοδεύει τον καταιονιστήρα κατά τέτοιο τρόπο, ώστε να αποφεύγονται ρύποι που προέρχονται από το δίκτυο ύδρευσης. Οι ρύποι από το δίκτυο ύδρευσης μπορούν να επηρεάσουν αρνητικά και/ ή να προξενήσουν ζημία στα λειτουργικά τμήματα του καταιονιστήρα (ντους). Τέτοιου είδους ζημιές δεν καλύπτονται από την εγγύηση Hansgrohe.

Τεχνικά Χαρακτηριστικά

Λειτουργία πίεσης:	έως 0,6 MPa
Συνιστώμενη λειτουργία πίεσης: (1 MPa = 10 bar = 147 PSI)	0,1 - 0,4 MPa
Θερμοκρασία ζεστού νερού:	έως 60 °C

Περιγραφή συμβόλων



Διαστάσεις (βλ. σελίδα 17 - 18)



Διάγραμμα ροής (βλ. Σελίδα 17 - 18)



Σήμα ελέγχου (βλ. Σελίδα 19)



Χειρισμός (βλ. σελίδα 20)



Καθαρισμός (βλ. Σελίδα 21 - 22) και συνημμένο φυλλάδιο



Ανταλλακτικά (βλ. σελίδα 23)

Varnostna opozorila

- ⚠ Pri montaži je treba nositi rokavice, da se preprečijo poškodbe zaradi zmečkanja ali urezov.
- ⚠ Éviter le contact du jet de la douchette avec les parties sensibles du corps (telles par ex. que les yeux). Veiller à respecter un écart suffisant entre la douchette et le corps
- ⚠ Prha se sme uporabljati le z namenom vzdrževanja higiene oziroma umivanja kopalnice in telesa.

Navodila za montažo

- Filter, ki je priložen ročni prhi, je potrebno vgraditi, da prho zaščitimo pred umazanijo iz vodovodne napeljave. Umazanija lahko okvari ali poškoduje dele ročne prhe. Za tako nastalo škodo Hansgrohe ne odgovarja.

Tehnični podatki

Delovni tlak:	maks. 0,6 MPa
Priporočeni delovni tlak: (1 MPa = 10 bar = 147 PSI)	0,1 - 0,4 MPa
Temperatura tople vode:	maks. 60 °C

Opis simbola



Mere (glejte stran 17 - 18)



Diagram pretoka
(glejte stran 17 - 18)



Preskusni znak (glejte stran 19)



Upravljanje (glejte stran 20)



Čiščenje (glejte stran 21 - 22) in priložena brošura



Rezervni deli (glejte stran 23)



Συναρμολόγηση
βλ. Σελίδα 19



Montaža
glejte stran 19



Ohutusjuhised

-  Kandke paigaldamisel muljumis- ja löikevigastuste vältimiseks kindaid.
-  Duši veejoad ei tohi kokku puutuda tundlike kehaosadega (nt silmad). Jätke duši ja keha vahele piisav vahe.
-  Dušši tohib kasutada ainult vanniskäimiseks, hügieeniks ja keha pesemiseks.



Paigaldamisjuhised

- Kaitsmaks dušši torust tuleva mustuse eest, on vaja paigaldada dušiga kaasasolev mustusesööel. Sissetulev mustus võib funktsioneerimist kahjustada ja/või rikkuda duši detaile. Sellest tulenevate kahjude eest Hansgrohe ei vastuta.

Tehnilised andmed

Töörõhk	maks. 0,6 MPa
Soovitavat töörõhk: (1 MPa = 10 baari = 147 PSI)	0,1 - 0,4 MPa
Kuuma vee temperatuur:	maks. 60°C

Drošības norādes

-  Montāžas laikā, lai izvairītos no saspiedumiem un iegriezumiem, nepieciešams nēsāt cimdus.
-  Nepieciešams izvairīties no dušas strūkļas tieša kontakta ar jutīgām ķermeņa daļām (piem., acīm). Nepieciešams ievērot pietiekošu attālumu starp dušu un ķermeni.
-  Dušu drīkst izmantot vienīgi vannošānās, higiēnas un ķermeņa tīrīšanas nolūkiem.

Norādījumi montāžai

- Jāiemonē dušas komplektā esošais filtrs, lai novērstu netīrumu ieplūšanu no ūdens vada. Ieskalotie netīrumi var traucēt dušas funkciju un / vai arī izraisīt rokas dušas daļu bojājumus, par kuriem Hansgrohe nenes atbildību.

Tehniskie dati

Darba spiediens:	maks. 0,6 MPa
Ieteicamais darba spiediens: (1 MPa = 10 bar = 147 PSI)	0,1 - 0,4 MPa
Karstā ūdens temperatūra:	maks. 60°C

Sūmbolite kirjeldus



Mõõtude (vt lk 17 - 18)



Läbivooludiagramm (vt lk 17 - 18)



Kontrollsertifikaat (vt lk 19)



Kasutamine (vt lk 20)



Puhastamine (vt lk 21 - 22) ja kaasasolev brošüür



Varuosad (vt lk 23)

Simbolu nozīme



Izmērus (skat. 17 - 18. lpp.)



Caurplūdes diagramma (skat. lpp. 17 - 18)



Pārbaudes zīme (skat. lpp. 19)



Lietošana (skat. 20. lpp.)



Tīrīšana (skat. lpp. 21 - 22) un klāt pievienotais buklets



Rezerves daļas (skat. 23. lpp.)

Paigaldamine
vt lk 19



Montāža
skat. lpp. 19



Sigurnosne napomene

- ⚠ Prilikom montaže se radi sprečavanja prignječenja i posekotina moraju nositi rukavice.
- ⚠ Mora se izbegavati kontakt mlaza iz tuša sa osetljivim delovima tela (npr. očima). Telo korisnika mora biti na dovoljnom odstojanju od tuša.
- ⚠ Tuš sme da se koristi samo za kupanje, tuširanje i ličnu higijenu.

Instrukcije za montažu

- Obavezno ugradite mrežicu upakovanu s tušem, čime sprečavate ulazak prljavštine iz vodovoda. Prljavština može dovesti do delimičnog ili potpunog oštećenja delova tuša. Za eventualna oštećenja uzrokovana prljavštinom proizvođač Hansgrohe nije odgovoran.

Tehnički podaci

Radni pritisak:	maks. 0,6 MPa
Preporučeni radni pritisak: (1 MPa = 10 bar = 147 PSI)	0,1 - 0,4 MPa
Temperatura vruće vode:	maks. 60 °C

Sikkerheshenvisninger

- ⚠ Bruk hansker under montasjen for å unngå klem- og kuttskader.
- ⚠ Dusjstrålen skal ikke komme i kontakt med ømfintlige kroppsdeler (f.eks. øynene). Overhold en tilstrekkelig avstand mellom dusjen og kroppen.
- ⚠ Dusjen skal kun brukes for bading, til hygieneformål og til kroppsrengjøring

Montagehenvisninger

- Silpakingen som er levert med dusjen skal bygges inn for å forhindre at smuss spyles inn fra ledningsnettet. Innspylt smuss kan påvirke funksjonen negativt og/eller kan medføre skader på hånddusjens funksjonsdeler. Hansgrohe påtar seg inget ansvar for skader som resulteres av dette.

Tekniske data

Driftstrykk	maks. 0,6 MPa
Anbefalt driftstrykk: (1 MPa = 10 bar = 147 PSI)	0,1 - 0,4 MPa
Varmtvannstemperatur	maks. 60 °C

Opis simbola



Mere (vidi stranu 17 - 18)



Dijagram protoka (vidi stranu 17 - 18)



Ispitni znak (vidi stranu 19)



Rukovanje (vidi stranu 20)



Čišćenje (vidi stranu 21 - 22) i priložena brošura



Rezervni delovi (vidi stranu 23)

Symbolbeskrivelse



Mål (se side 17 - 18)



Gjennomstrømningsdiagram (se side 17 - 18)



Prøvermerke (se side 19)



Betjening (se side 20)



Rengjøring (se side 21 - 22) og vedlagt brosjyre





Servicelever (se side 23)





Указания за безопасност

-  При монтажа трябва да се носят ръкавици, за да се избегнат наранявания поради притискане или порязване.
-  Трябва да се избягва контакта на струите на разпръскателя с чувствителни части на тялото (напр. очите). Между разпръскателя и тялото трябва да се спазва достатъчно разстояние.
-  Позволено е използването на разпръскателя само за къпане, хигиена и цели на почистване на тялото.

Указания за монтаж

- Опакованото заедно с разпръскателя уплътнение с цедка трябва да се монтира, за да се избегне натрупване на замърсявания от водопроводната мрежа. Натрупването на замърсявания може да наруши функцията и/или да доведе до увреждания на функционалните части на разпръскателя, Hansgrohe не носи отговорност за получените се по този начин щети.

Технически данни

Работно налягане:	макс. 0,6 МПа
Препоръчително работно налягане:	0,1 - 0,4 МПа
	(1 МПа = 10 bar = 147 PSI)
Температура на горещата вода:	макс. 60°C

Описание на символите



Размери (вижте стр. 17 - 18)



Диаграма на потока (вижте стр. 17 - 18)



Контролен знак (вижте стр. 19)



Обслужване (вижте стр. 20)





Почистване (вижте стр. 21 - 22) и приложена брошура



Сервизни части (вижте стр. 23)

Udhëzime sigurie

-  Për të evituar lëndimet e pickimeve ose të prerjeve gjatë procesit të montimit duhet që të vishni doreza.
-  Kontakti i valëve të dushit me pjesët e ndjeshme të trupit (p.sh. me sytë) duhet që të shmanget. Midis dushit dhe trupit duhet që të mbahet një distancë e mjaftueshme.
-  Dushi duhet të përdoret vetëm për qëllimet e banjave, të higjienës dhe të larjes së trupit.

Udhëzime për montimin

- Sita që i kemi bashkëngjitur spërkatëses duhet përdorur për të evituar thithjen e papastërtive nga rrjeti i ujësjellësit. Ndotjet mund të dëmtojnë pjesë funksionale të spërkatëses. Hansgrohe nuk merr përgjegjësinë për dëmet e shkaktuara në këtë mënyrë.

Të dhëna teknike

Presioni gjatë punës	maks. 0,6 MPa
Presioni i rekomanduar:	0,1 - 0,4 MPa
	(1 MPa = 10 bar = 147 PSI)
Temperatura e ujit të ngrohtë	maks. 60°C

Përshkrimi i simbolit



Përmasat (shih faqen 17 - 18)



Diagrami i qarkullimit (shih faqen 17 - 18)



Shenja e kontrollit (shih faqen 19)



Përdorimi (shih faqen 20)



Pastrimi (shih faqen 21 - 22) dhe broshura bashkëngjitur



Pjesë ndërrimi (shih faqen 23)

Монтаж
вижте стр. 19



Montimi
shih faqen 19



تنبيهات الأمان



يجب إرتداء قفازات لليد أثناء التركيب لتجنب حدوث أخطار الإنحشار أو الجروح.



يجب تجنب حدوث إتصال مباشر بين الماء الخارج من رأس الدش وبين أجزاء الجسم الحساسة (مثل العينين). يجب وجود مسافة كافية بين رأس الدش والجسم.



يسمح باستخدام الدش فقط لأغراض الإستحمام، والأغراض الصحية، وتنظيف الجسم.



تعليمات التركيب

- يجب إدخال الحلقة الشبكية لحماية الدش اليدوي من الأوساخ التي تحملها شبكة المواسير. حيث تؤدي الأوساخ الواردة إلى حدوث أعطال أو / و قد تتسبب في تلف أجزاء من من الدش، ومثل هذه الأعطال تلغي كافة المطالبات الخاصة بالمسؤولية أو الضمان.

المواصفات الفنية

ضغط التشغيل: الحد الأقصى 0,6 ميجاباسكال
 ضغط التشغيل الموصى به: 0,1 - 0,4 ميجاباسكال
 (1 ميجاباسكال = 10 بار = PSI 147)
 الحد الأقصى 60°C درجة حرارة الماء الساخن:

وصف الرمز

أبعاد (راجع صفحة 17 - 18)

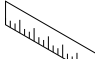

رسم للصرف (راجع صفحة 17 - 18)



شهادة اختبار (راجع صفحة 19)



التشغيل (راجع صفحة 20)



التنظيف (راجع صفحة 21 - 22)



قطع الغيار (راجع صفحة 23)

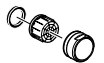

راجع صفح 19

الترتيب



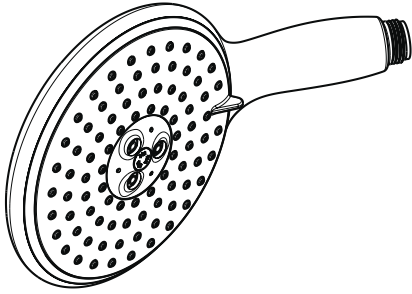

Raindance E 150 AIR 3je
28551000

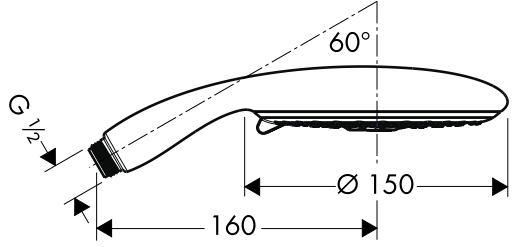

Raindance E 120 AIR 3jet
28549000

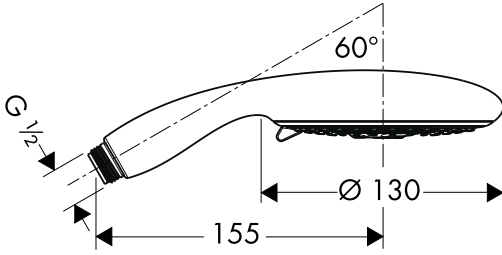

Raindance E 100 AIR 3jet
28553000

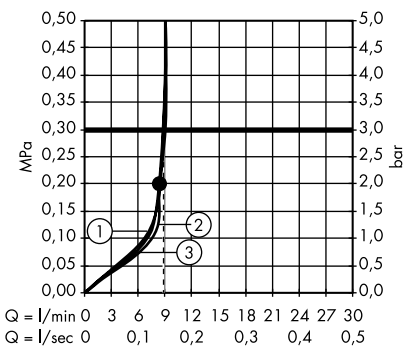
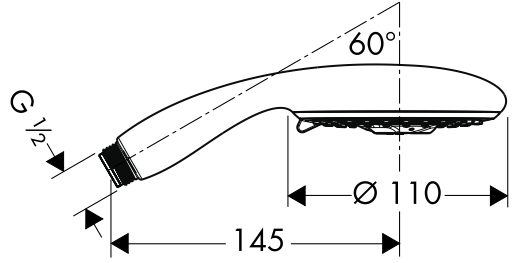

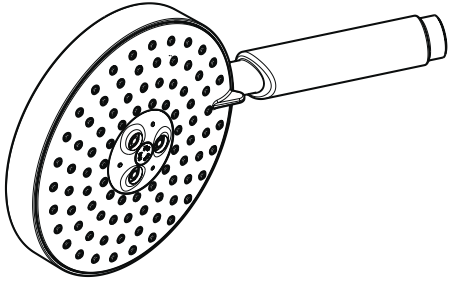

Raindance S 150 AIR 3jet
28550000

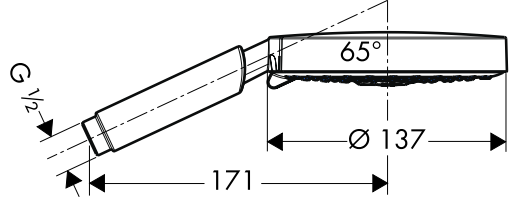

Raindance S 120 AIR 3jet
28554000

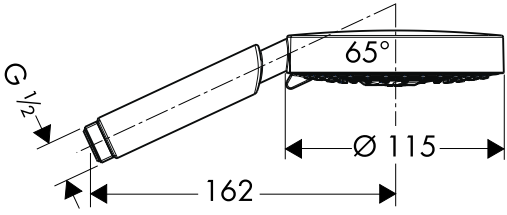

Raindance S 100 AIR 3jet
28552000

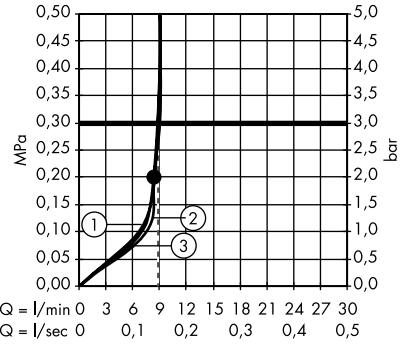
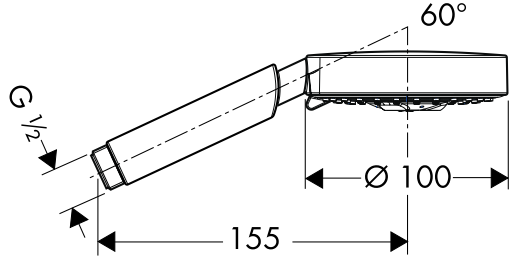



	P-IX	DVGW	SVGW	WRAS	KIWA	NF	ACS	ETA
28550000				X			X	
28550003								
28551000				X			X	
28551003								
28552000				X			X	
28553000				X			X	
28549000							X	
28554000							X	

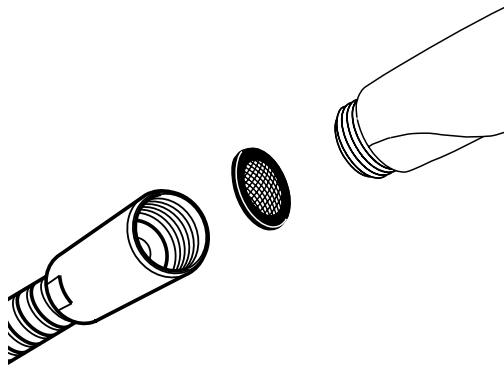

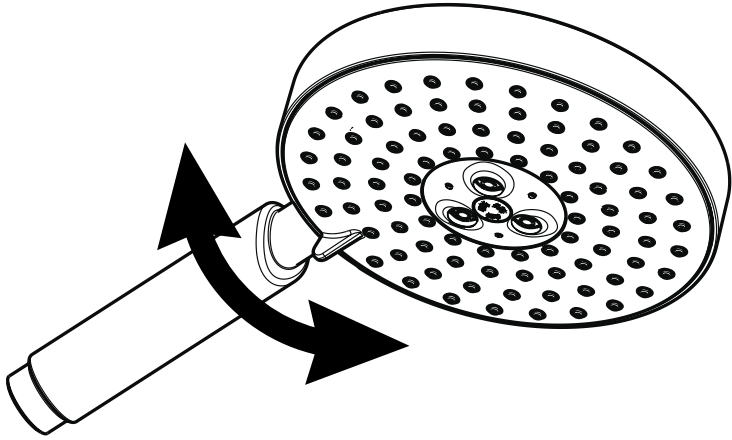



- DE** Einfach sauber: Kalk lässt sich von den Noppen ganz leicht abrubbeln.
- FR** La propreté en toute simplicité: les dépôts formés sur les buses élastiques en silicone s'éliminent par un simple passage de la main.
- EN** Just clean: simply rub over the spray nozzles to remove lime scale.
- IT** Facile da pulire: Il calcare viene eliminato semplicemente dagli ugelli elastici in silicone.
- ES** Fácil asear: La cal se puede retirar sencillamente frotando con los dedos de las toberas elásticas de silicona.
- NL** Eenvoudig schoon: Kalk kan eenvoudig van de noppen worden gewreven.
- DK** Enkel rengøring: Det er let at fjerne kalkaflejringer fra stråledyserne.
- PT** Simplesmente limpo: o calcário pode ser simplesmente retirado das saliências através de fricção.
- PL** Po prostu czysto: Pęczki można całkiem łatwo oczyścić z kamienia.
- CS** Jednoduše čistě: Vapenné usazeniny můžete z noplek snadno odstranit otřením.
- SK** Jednoducho čistý: Vodný kameň sa dá zo štetín celkom ľahko odstrániť.
- ZH** 清洁: 只需要揉搓花洒表面的出水孔即可去除水垢。

- RU** Простота чистки: известь очень легко стирается с утолщений.
- HU** Egyszerűen tisztá: a vízkő egészen könnyen ledörzsölhető a csomókról.
- FI** Yksinkertaisesti puhdas: kalkin voi helposti hieroa irti nyytistä.
- SV** Enkelt att göra rent: det är lätt att ta bort kalk från pöpporna.
- LT** Paprasta švara: kalkės lengvai nugrandomos nuo kilpos.
- HR** Jednostavno čisto: Kamenac se sasvim lako uklanja s izbočina.
- TR** Sadece temiz: Kireç, düğümlemlerle kolayca ovalanabilir.
- RO** Pur și simplu curat: Calcarul se îndepărtează ușor de pe noduri prin frecare.
- EL** Απλά τέλεια καθαριότητα: Τα αλάτα μπορούν να αφαιρεθούν με μεγάλη ευκολία από τα στόμια.
- SL** Preprosto čisto: arpenec se z lahkoto podrgne z vozličkov.
- ET** Lihtsalt puhas: lupja saab nuppu deli lihtsalt maha hõõruda.
- LV** Vienkārša tīrīšana: kaļķis no izvirzījumiem ir viegli norubināms.
- SR** Jednostavno čisto: Kamenac se sasvim lako skida sa izbočina.
- NO** Simpelt en ren: Ved å gnikke er det lett å fjerne kalk fra nuppene.
- BG** Просто чисто: Варовикът лесно може да се изтърси от удебеленията.
- SQ** Thjesht dhe pastër. Mbetjet gëlqerore mund të hiqen me fërkim të lehtë.
- AR** إنه سهل التنظيف، حيث يسقط الجير بسهولة شديدة من الأجزاء الناتئة.

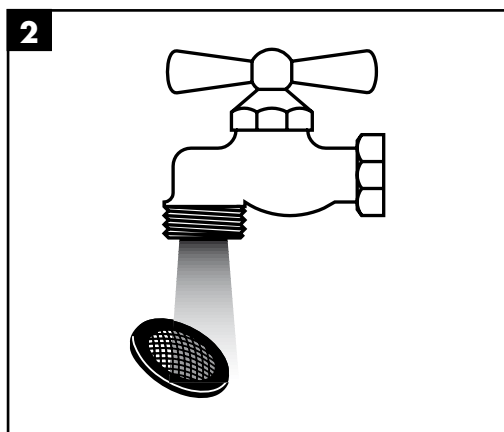
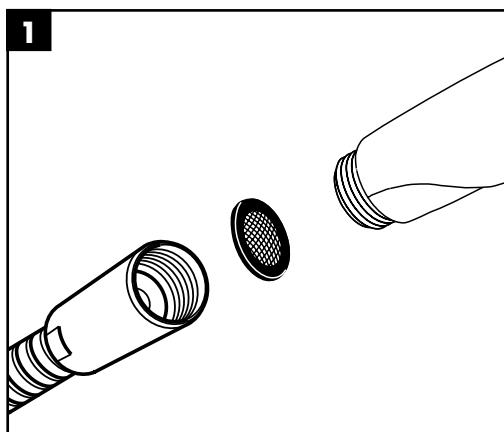
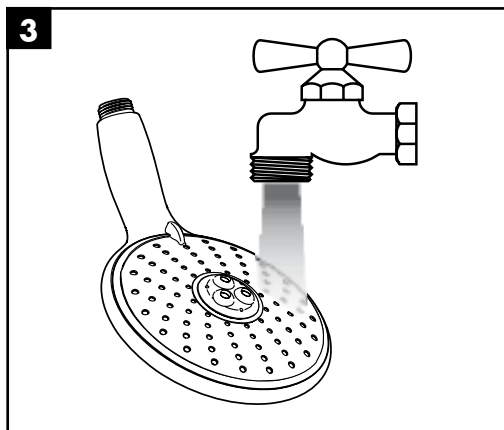
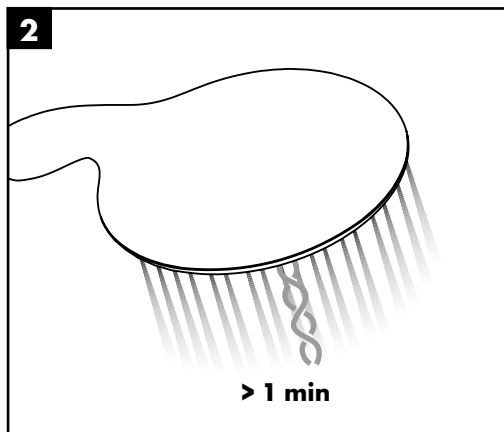
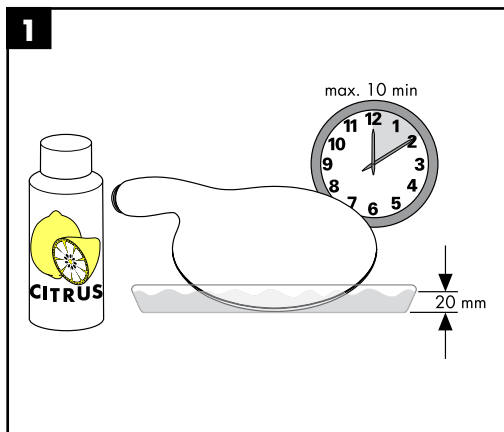

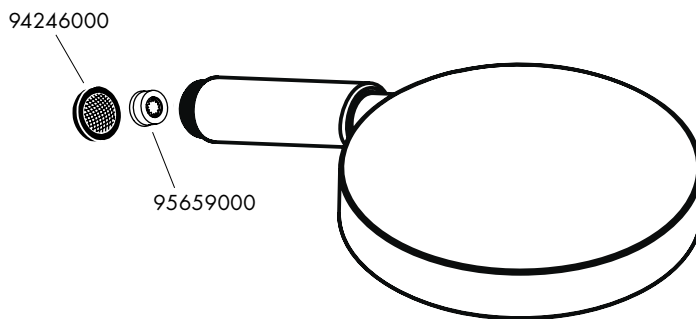
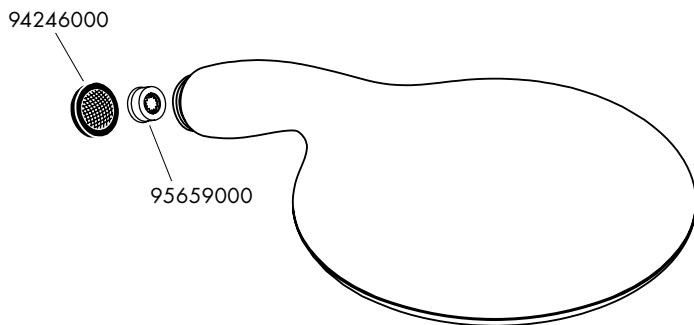

hansgrohe

Hansgrohe - Postfach 1145 · D-77761 Schiltach · Telefon +49 (0) 78 36/51-1282 · Telefax +49 (0) 7836/511440
E-Mail: info@hansgrohe.com · Internet: www.hansgrohe.com

06/2010
9.05961.06