

DE	Gebrauchsanleitung / Montageanleitung	2
FR	Mode d'emploi / Instructions de montage	12
EN	Instructions for use / assembly instructions	22
IT	Istruzioni per l'uso / Istruzioni per Installazione	32
ES	Modo de empleo / Instrucciones de montaje	42
NL	Gebruiksaanwijzing / Handleiding	52
DK	Brugsanvisning / Monteringsvejledning	62
PT	Instruções para uso / Manual de Instalação	72
PL	Instrukcja obsługi / Instrukcja montażu	82
CS	Návod k použití / Montážní návod	92
SK	Návod na použitie / Montážny návod	102
ZH	用户手册 / 组装说明	112
RU	Руководство пользователя / Инструкция по монтажу	122
HU	Használati útmutató / Szerelési útmutató	132
FI	Käyttöohje / Asennusohje	142
SV	Bruksanvisning / Monteringsanvisning	152
LT	Vartotojo instrukcija / Montavimo instrukcijos	162
HR	Upute za uporabu / Uputstva za instalaciju	172
TR	Kullanım kılavuzu / Montaj kılavuzu	182
RO	Manual de utilizare / Instrucțiuni de montare	192
EL	Οδηγίες χρήσης / Οδηγία συναρμολόγησης	202
SL	Navodilo za uporabo / Navodila za montažo	212
ET	Kasutusjuhend / Paigaldusjuhend	222
LV	Lietošanas pamācība / Montāžas instrukcija	232
SR	Uputstvo za upotrebu / Uputstvo za montažu	242
NO	Bruksanvisning / Montasjeveiledning	252
BG	Инструкция за употреба / Инструкция за употреба	262
SQ	Udhëzuesi i përdorimit / Udhëzime rreth montimit	272
AR	دليل الاستخدام / تعليمات التجميع	282

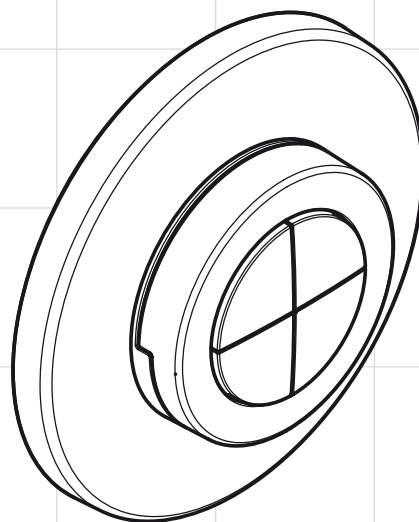

iControl mobile

15942000 / 15943000
15944000 / 15945000

Normen und Richtlinien:

Die Anwendung des Produktes ist durch folgende Richtlinien gewährleistet:

- EN 15200
- EN 60335-2-105



Sicherheitshinweise:

- Das Produkt darf nur zu Bade-, Hygiene- und Körperreinigungszwecke eingesetzt werden.
- Kinder dürfen nicht unbeaufsichtigt das Duschsystem benutzen.
- Kinder, sowie Erwachsene mit körperlichen, geistigen und / oder sensorischen Einschränkungen dürfen nicht unbeaufsichtigt das Duschsystem benutzen. Personen die unter Alkohol- oder Drogen Einfluss stehen, dürfen das Duschsystem nicht benutzen.
- Der Kontakt der Brausestrahlen mit empfindlichen Körperstellen (z. B. Augen) muss vermieden werden. Es muss ein ausreichender Abstand zwischen Brause und Körper eingehalten werden.
- Große Druckunterschiede zwischen den Kalt- und Warmwasseranschlüssen müssen ausgeglichen werden.



Elektroanschluss:

- Die Installations- und Prüfungsarbeiten sind von einer zugelassenen Elektrofachkraft, unter Berücksichtigung von VDE 0100 Teil 701 u. IEC 60364-7-701, auszuführen.
- Für den elektrischen Anschluss wird lediglich eine Steckdose benötigt. Die Stromversorgung erfolgt über einen externen Trafo.
- In unmittelbarer Nähe dürfen sich keine leicht entflammaren Materialien befinden.
- Die Umgebungstemperatur darf nicht größer als 50 °C sein.
- Die gesamte Stromversorgung erfolgt über einen 230V/N/PE/50Hz Wechselstromanschluss.
- Die Absicherung muss über eine Fehlerstrom-Schutzeinrichtung (RCD/FI) mit einem Bemessungsdifferenzstrom ≤ 30 mA erfolgen.
- Wenn ein Potenzialausgleich erforderlich ist, so ist dieser bauseits zu erstellen.
- Bei der Elektroinstallation sind die entsprechenden VDE-, Landes- und EVU-Vorschriften in der jeweils gültigen Fassung einzuhalten.
- Es muss gewährleistet sein dass das Produkt vom Netz getrennt werden kann. Entweder durch einen frei zugänglichen Stecker oder durch einen allpoligen Schalter nach EN 60335-1 Abs. 24.3.



Montage: (siehe Seite 303)

- **Achtung!** Die Armatur muss nach den gültigen Normen montiert, gespült und geprüft werden. (Installation nach EN 1717)
- Sämtliche Arbeiten dürfen nur im spannungsfreien Zustand vorgenommen werden.
- Der Grundkörper 15941180 kann nur senkrecht eingebaut werden! Montage mit Verstellring ist nur im vorderen und mittleren Bereich möglich.
- Alle Komponenten müssen zugänglich bleiben.

Technische Daten

Betriebsdruck:	max. 1 MPa
Empfohlener Betriebsdruck:	0,1 - 0,5 MPa
Prüfdruck:	1,6 MPa
(1 MPa = 10 bar = 147 PSI)	
Heißwassertemperatur:	max. 80 °C
Empfohlene Heißwassertemperatur:	65 °C
Anschlussmaße:	G 3/4
Anschlüsse Eingang:	Mischwasser
Freier Durchfluss bei 0,3 MPa	
1 Verbraucher:	35 l/min
2 Verbraucher:	45 l/min
Prüfzeichen:	beantragt



Zubehör (siehe Seite 4)



Maße: (siehe Seite 292)



Montagebeispiele Raindance Rainfall: (siehe Seite 295)



Montagebeispiele Raindance Rainmaker: (siehe Seite 299)



Bedienung: (siehe Seite 6)

- Bei einem Ausfall der 230 V Netzspannung kann die Duscheinrichtung nicht in Betrieb genommen werden.
- Das Produkt ist nicht für die Verwendung in Verbindung mit einem Dampfbad vorgesehen!



Reinigung Schmutzfangsieb: (siehe Seite 309)

Ersatzteile (siehe Seite 311)



























Montage siehe Seite 303

Deutsch

Technische Informationen

Störung	Ursache	Abhilfe
Keinerlei Funktion	<ul style="list-style-type: none"> - keine Spannungsversorgung - Trafo vom Grundset defekt - Empfänger ungünstig platziert / defekt - Sender nicht eingelernt / defekt 	<ul style="list-style-type: none"> - Spannungsversorgung sicherstellen - Trafo austauschen - Empfängerposition verändern bzw. Empfänger austauschen - Sender einlernen / austauschen
Betriebsmodus lässt sich nicht konfigurieren	<ul style="list-style-type: none"> - Reed Kontakt nicht an geeigneter Position hinter der Rosette - Reed Kontakt fehlerhaft 	<ul style="list-style-type: none"> - Reed Kontakt an der Rosette platzieren - Anschlussleitung Magnetventil austauschen
Keine Lichtfunktion	<ul style="list-style-type: none"> - Trafo Rainmaker nicht eingesteckt / fehlerhaft - Zuleitungen Lichtrelais fehlerhaft / defekt 	<ul style="list-style-type: none"> - Spannungsversorgung Trafo sicherstellen / Trafo austauschen - Verbindungen und Lichtrelais prüfen / austauschen
Verbraucher stellen selbständig ab	<ul style="list-style-type: none"> - Laufzeit im Programmmodus hinterlegt 	<ul style="list-style-type: none"> - Nachlaufzeit im Service-Modus verlängern / abschalten
Armatur undicht	<ul style="list-style-type: none"> - Magnetventil verschmutzt / defekt 	<ul style="list-style-type: none"> - Magnetventilmembrane reinigen / austauschen
Zu wenig Durchfluss	<ul style="list-style-type: none"> - Schmutzfängsieb auf der Eingangsseite verschmutzt 	<ul style="list-style-type: none"> - Schmutzfängsieb reinigen / austauschen

Symbole

 <p>Wasseranschluss DN 20 Warmwasser</p>	 <p>Trafo</p>	 <p>Potentialausgleich</p>
 <p>Wasseranschluss DN 20 Kaltwasser</p>	 <p>Empfänger</p>	 <p>alles aus</p>
 <p>Wasser öffnen</p>	 <p>Kodierstecker</p>	 <p>Licht</p>
 <p>Wasser abstellen</p>	 <p>230V</p>	 <p>Rain</p>
 <p>Ab • ist die Funktion gewährleistet.</p>	 <p>12V</p>	 <p>Whirl</p>
 <p>Die Abflaufleistung muss mehr als 50 l/min betragen.</p> <p>> 50 l/min</p>	 <p>Leerrohr</p>	 <p>Rainflow</p>
 <p>Ablauf</p>	 <p>Lichtsteuerung 27189000 (nicht im Lieferumfang)</p>	 <p>Rain AIR XXL</p>
<p>Raindrain</p>  <p>Mitte Duschwanne</p>	 <p>Licht-Relais Rainmaker</p>	 <p>Rain AIR</p>
	 <p>Trafo Rainmaker</p>	 <p>Silikon (essigsäurefrei!)</p>
	 <p>Bauseits vorinstallierter 12 V-Anschluss für Licht (max. 80 W)</p>	

Montage siehe Seite 303

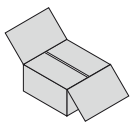

Deutsch Zubehör

Trafo:

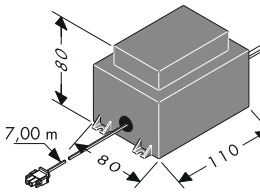

Die Leistung des externen Trafos beträgt 50 VA. Der Trafo muss im Trockenbereich (Schutzzone 3) installiert werden. Der Trafo kann zusammen mit dem Empfänger in ein Kunststoffgehäuse, unter Berücksichtigung von EN/IEC 60335-1, eingebaut werden (Abmessungen ca. 250 x 160 x 92 mm, gehört nicht zum Lieferumfang). Das mitgelieferte Kabel ermöglicht die Installation des Trafos bis 7,00 m entfernt vom Empfänger. Dafür muss ein Leerrohr EN35 (gehört nicht zum Lieferumfang) vorgesehen werden. Das Leerrohr muss mindestens alle 500 mm fixiert werden und der Biegeradius muss größer als 100 mm sein. Die ca. 7,00 m lange Sekundärleitung des Trafos darf nicht gekürzt werden. Die nicht benötigte Lei-

tungslänge sollte in der Nähe des Trafos untergebracht werden. Eine beschädigte Anschlussleitung darf nicht ersetzt werden. Der Trafo darf dann nicht mehr betrieben werden.

Die Netzanschlussleitung dieses Trafos kann nicht ersetzt werden. Bei einer defekten Netzanschlussleitung muss die Leitung inklusive Trafo von einer Elektrofachkraft ersetzt werden.

Licht-Relais:

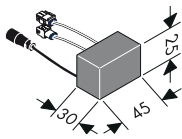

(nur bei Varianten mit integriertem Licht)
Das Licht-Relais darf maximal mit 12 V AC / 80 W belastet werden.
Ein Betrieb am 230 V Netz ist nicht zulässig

Lichtsteuerung:

27189000

(nicht im Lieferumfang enthalten)

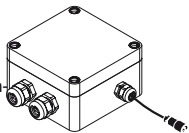

(iControl mobile 15944000)
Die Lichtsteuerung muss bei den Varianten mit externer Lichtquelle angeschlossen werden.
Die Lichtsteuerung muss jederzeit zugänglich sein.

Kodierstecker:

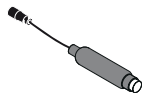

(Raindance Rainfall 28411000 / Raindance Rainmaker 28403000)
Der Kodierstecker muss bei den Varianten ohne Licht angeschlossen werden.
Wenn der Service-Modus bei den Varianten ohne Licht aktiviert ist, zeigt die Leuchtdiode des Kodiersteckers die optischen Rückmeldungen an.
Der Kodierstecker muss jederzeit zugänglich sein.

Anschlussleitung Magnetventilblock / Anschlussleitung Licht:



Die 7,50 m lange Magnetventilblockleitung sowie die 10,00 m lange Lichtleitung dürfen nicht gekürzt werden. Die nicht benötigte Leitungslänge sollte in der Nähe des Empfängers untergebracht werden.

Die Magnetventilblockleitung darf nur in dem mitgelieferten Leerrohr (EN 20) verlegt werden. Das Leerrohr muss mindestens alle 500 mm fixiert werden und der Biegeradius muss größer als 100 mm sein.

Achtung: In dem Leerrohr für die Magnetventilblockleitung dürfen keine elektrischen Leitungen verlegt werden, die eine Spannung größer 12V führen.

Montage siehe Seite 303

Deutsch Zubehör

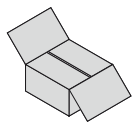

Empfänger:

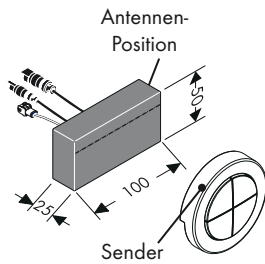

Der Empfänger sollte vorzugsweise im gleichen Raum wie die Duscheinrichtung montiert sein. Wenn dies nicht möglich sein sollte, kann der Empfänger auch in einem Raum montiert werden, der an die Duscheinrichtung angrenzt. Der Empfänger darf nicht in ein Metallgehäuse eingebaut werden, da sonst die Funksignale des Senders abgeschirmt werden. Weiterhin sollte darauf geachtet werden, dass sich möglichst wenig abschirmende Metallteile in der Nähe des Empfänger-Einbauortes befinden.

Für eine optimale Erkennung der Funksignale sollte die Antenne des Empfängers möglichst dem Sender zugewendet sein.

Sender:



Bei Auslieferung ist der Sender bereits auf den Empfänger eingelernt. Durch identische Seriennummern kann der Sender dem Empfänger zugeordnet werden. Zusätzliche bzw. nachträglich erworbene Sender müssen eingelernt werden. Es können maximal vier Sender eingelernt bzw. gespeichert werden. (siehe Seite 10/11 Anmelde-Modus). Die Funkfrequenz des Senders ist 868,3 MHz.

Hinweis: Empfänger und Sender (Fernbedienung) haben eine Reichweite von ca. 10,00 m. Die Reichweite ist abhängig davon, wie stark die Funksignale zwischen Sender und Empfänger gedämpft werden.

Hinweis: Aus Sicherheitsgründen den Sender nur im Sichtbereich des Duschsystems benutzen. Es könnte sonst versehentlich Wasser eingeschaltet werden.

Hinweis: Korrekte Vorgehensweise bei Austausch eines defekten Senders gegen einen neuen Sender:

1. Alle Sender löschen. (Anmelde-Modus ⇒ Löschmodus).
2. Alle Sender, außer dem defekten Sender, erneut einlernen. (Service-Modus ⇒ Anmelde-Modus).

Material	Dämpfung
Holz, Gips, Glas (unbeschichtet, ohne Metall)	0 - 10 %
Backstein, Pressspanplatten	5 - 35 %
Beton mit Armierung aus Eisen	10 - 90 %
Metall, Aluminiumkaschierung	90 - 100 %

Magnet:



Für die Aktivierung des Service-Modus muss der Magnet den REED-Kontakt (hinter der Rosette) betätigen. (siehe Seite 8/9, Service-Modus).

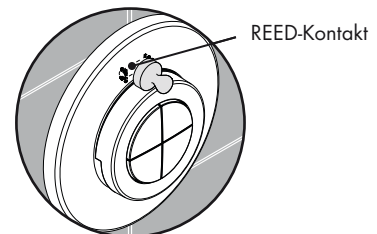

Montage siehe Seite 303

Raindance Rainfall

28411000

iControl mobile

15940180 / 15942000

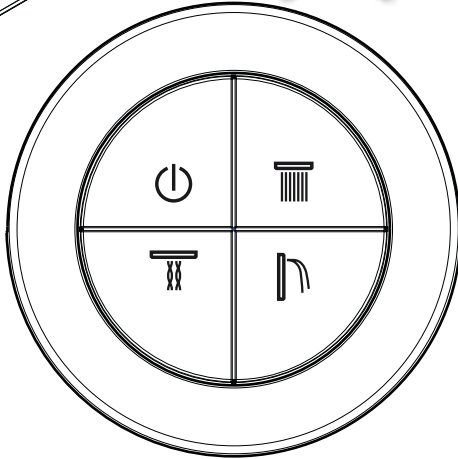
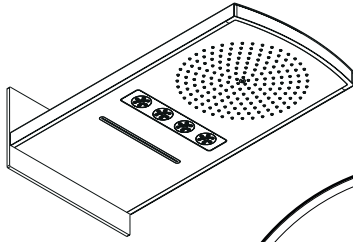

Raindance Rainfall

28411000

iControl mobile

15941180 / 15944000

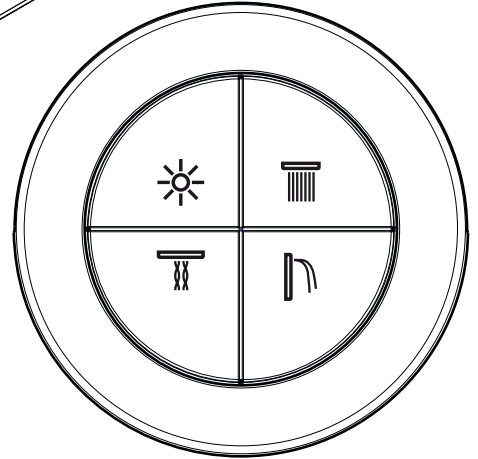
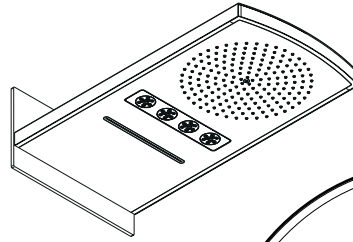

Raindance Rainmaker

28403000

iControl mobile

15940180 / 15943000

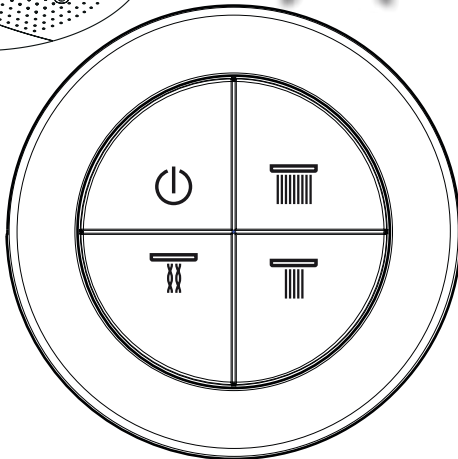
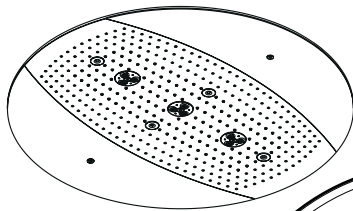

Raindance Rainmaker

28404000

iControl mobile

15941180 / 15945000

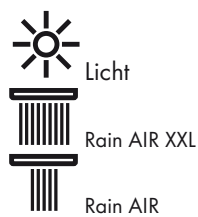
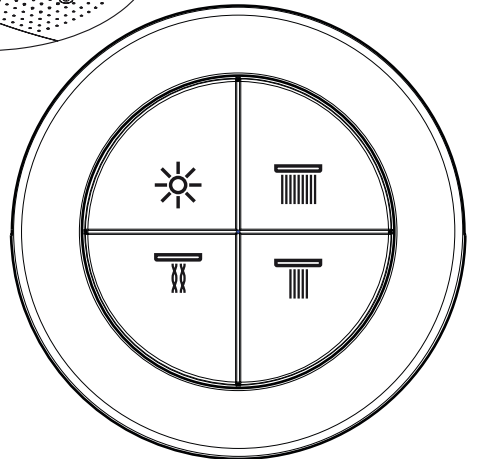
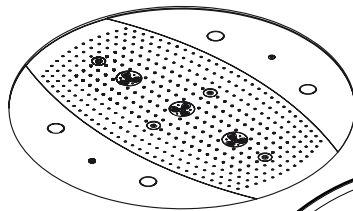

Montage siehe Seite 303

Brausen und Licht Ein- und Ausschalten:

(Standardfunktion mit Licht)

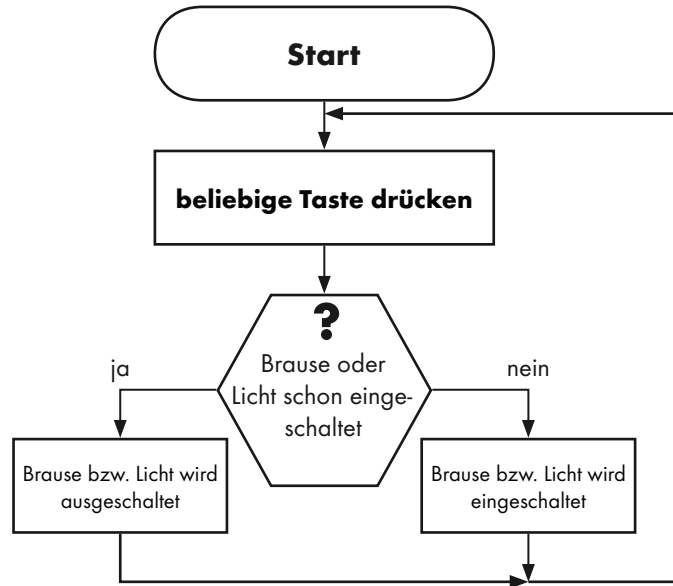

Brausen Ein- und Ausschalten:

(Standardfunktion ohne Licht)

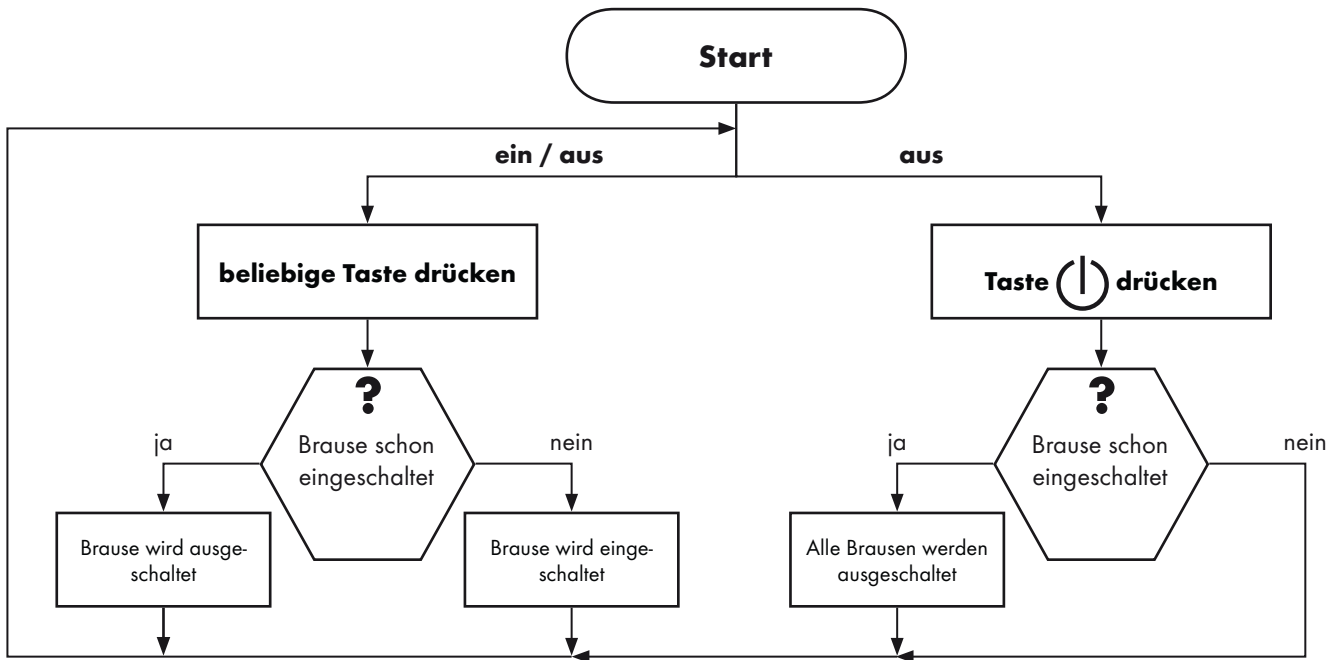

Deutsch Bediener-Ebene

Raindance Rainfall
28411000

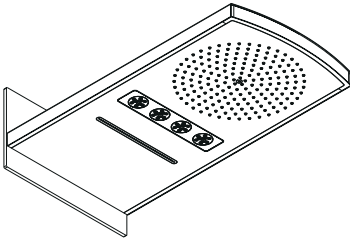

Betriebs-Modus

Hinweis:
Alle Brausen müssen ausge-
schaltet sein



Service-Modus

Hinweis:
Licht / Kodierstecker blinkt
4x

Hinweis:
Licht / Kodierstecker geht
aus

Hinweis:
Licht / Kodierstecker blinkt
2x

< 15 sek.

> 15 sek.

Taste oder
doppelklicken

Taste
doppelklicken

Maximallaufzeit-Modus

Hinweis:
Licht / Kodierstecker blinkt im
1 sek. Takt

Brausen-Modus

Hinweis:
Licht / Kodierstecker blinkt im
3sek. Takt

< 15 sek.

> 15 sek.

< 15 sek.

> 15 sek.

Taste oder drücken	Taste drücken	Taste drücken	Taste drücken
------------------------	------------------	------------------	------------------

Taste oder drücken	Taste drücken
------------------------	------------------

Laufzeiten: Brausen: 30 s Licht: 30 min	Standard: Laufzeiten: Brausen: 60 s Licht: 30 min	Laufzeiten: Brausen: 180 s Licht: 30 min	Laufzeiten: Brausen + Licht: unendlich
--	--	---	---

Standard max. 2 Brausen können eingeschaltet werden	Komfort 1: alle Brausen können gleichzeitig eingeschaltet werden
---	---

Deutsch Bediener-Ebene

Raindance Rainmaker
28403000 / 28404000

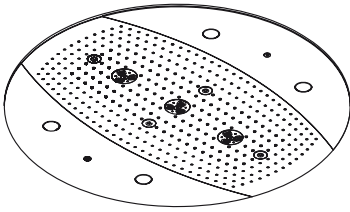

Betriebs-Modus

Hinweis:
Alle Brausen müssen ausgeschaltet sein



Service-Modus

Hinweis:
Licht / Kodierstecker blinkt 4x

Hinweis:
Licht / Kodierstecker geht aus

Hinweis:
Licht / Kodierstecker blinkt 2x

< 15 sek.

> 15 sek.

Taste oder doppelklicken

Taste doppelklicken

Maximallaufzeit-Modus

Hinweis:
Licht / Kodierstecker blinkt im 1 sek. Takt

Brausen-Modus

Hinweis:
Licht / Kodierstecker blinkt im 3sek. Takt

< 15 sek.

> 15 sek.

< 15 sek.

> 15 sek.

Taste oder drücken

Taste drücken

Taste drücken

Taste drücken

Taste oder drücken

Taste drücken

Taste drücken

Laufzeiten:
Brausen: 30 s
Licht: 30 min

Standard:
Laufzeiten:
Brausen: 60 s
Licht: 30 min

Laufzeiten:
Brausen: 180 s
Licht: 30 min

Laufzeiten:
Brausen + Licht:
unendlich

Standard
max. 2 Brausen können eingeschaltet werden

Komfort 1:
alle Brausen können gleichzeitig eingeschaltet werden

Komfort 2:
größere Wassermenge, nur bei Rainmaker notwendig

Deutsch Experten-Ebene

Raindance Rainfall
28411000

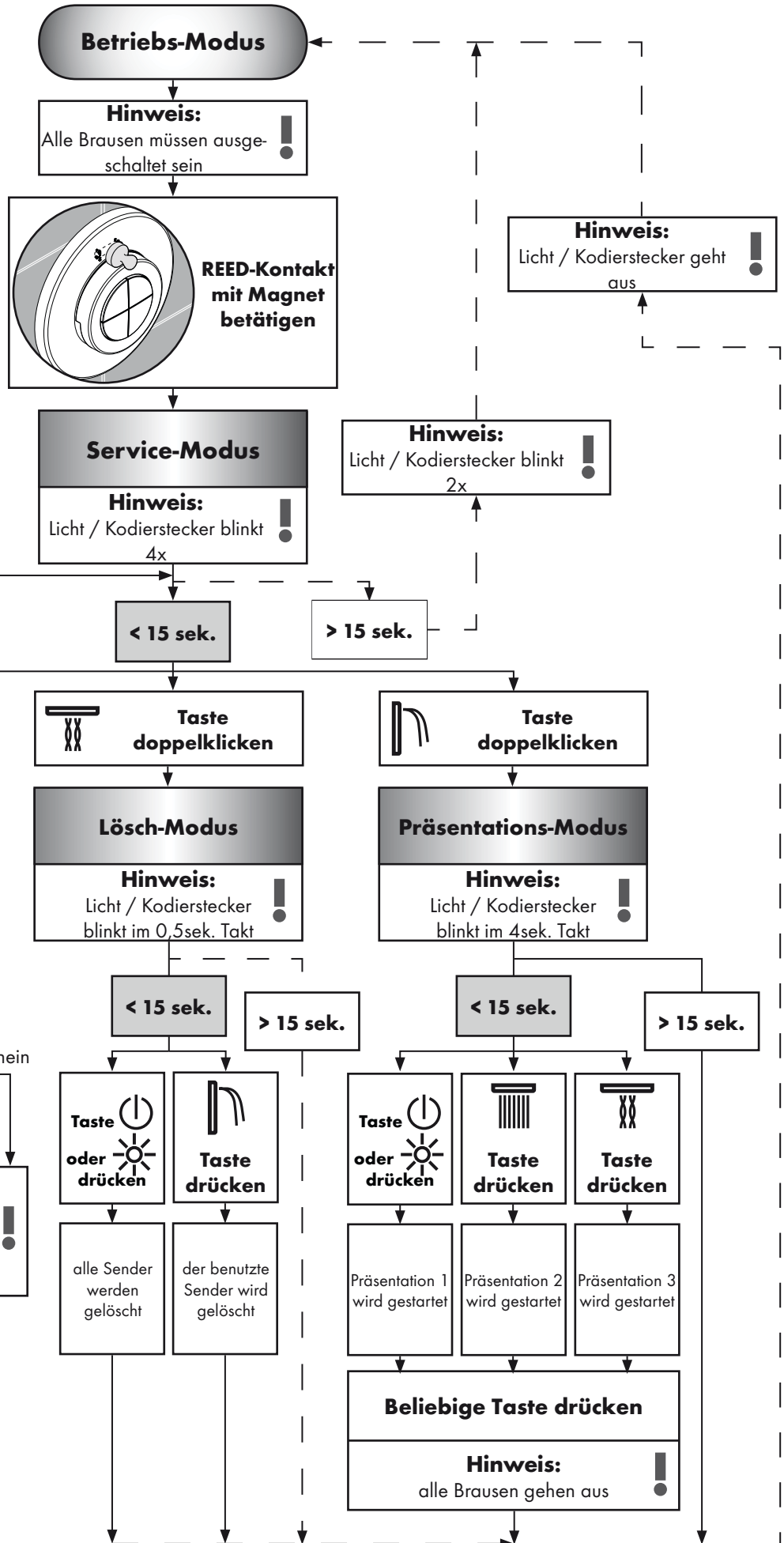
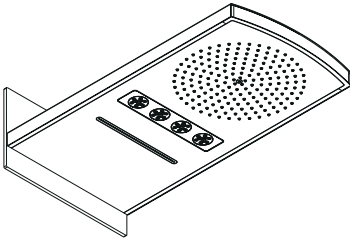

Deutsch Experten-Ebene

Raindance Rainmaker
28403000 / 28404000

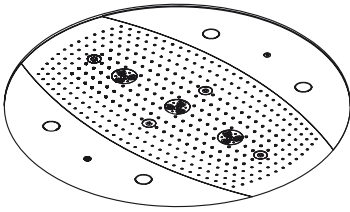

Betriebs-Modus

Hinweis:
Alle Brausen müssen ausgeschaltet sein



Service-Modus

Hinweis:
Licht / Kodierstecker blinkt 4x

Hinweis:
Licht / Kodierstecker blinkt 2x

Hinweis:
Licht / Kodierstecker geht aus

< 15 sek.

> 15 sek.

Beliebige Taste 1 x drücken

Taste doppelklicken

Taste doppelklicken

Anmelde-Modus

Lösch-Modus

Hinweis:
Licht / Kodierstecker blinkt im 0,5sek. Takt

Präsentations-Modus

Hinweis:
Licht / Kodierstecker blinkt im 4sek. Takt

?

ja nein

Ist der Sender bekannt

Hinweis:
Licht / Kodierstecker blinkt 1x
Anzahl der

?

ja nein

bekanntesten Sender ≤ 3 St.

Hinweis:
ältester bekannter Sender wird gelöscht

Hinweis:
Licht / Kodierstecker blinkt 3x
neuer Sender wird eingelesen bzw. gespeichert

< 15 sek.

> 15 sek.

< 15 sek.

> 15 sek.

Taste oder drücken

Taste drücken

alle Sender werden gelöscht

der benutzte Sender wird gelöscht

Taste oder drücken

Taste drücken

Taste drücken

Präsentation 1 wird gestartet

Präsentation 2 wird gestartet

Präsentation 3 wird gestartet

Beliebige Taste drücken

Hinweis:
alle Brausen gehen aus

Normes et réglementations:

L'utilisation du produit est garantie par les réglementations suivantes ::

- EN 15200
- EN 60335-2-105



Consignes de sécurité:

- Le système de douche ne doit servir qu'à se laver et à assurer l'hygiène corporelle.
- Il est interdit aux enfants non surveillés d'utiliser la douche
- Il est interdit aux enfants ainsi qu'aux adultes ayant des insuffisances physiques, psychiques et/ou motrices d'utiliser la douche sans surveillance. De même, il est interdit à des personnes sous influence d'alcool ou de drogues d'utiliser la douche.
- Éviter le contact du jet de la douchette avec les parties sensibles du corps (telles par ex. que les yeux). Veiller à respecter un écart suffisant entre la douchette et le corps
- Il est conseillé d'équilibrer les pressions de l'eau chaude et froide.



Raccord électrique:

- Les travaux d'installation et de contrôle doivent être effectués par un électricien agréé en conformité avec les dispositions des normes VDE 0100 partie 701 et CEI 60364-7-701.
- Seule une prise est nécessaire pour le raccordement électrique. L'alimentation électrique est réalisée par un transformateur externe.
- Des matériaux facilement inflammables ne doivent pas se trouver à proximité immédiate.
- La température ambiante ne doit pas être supérieure à 50°C.
- L'ensemble de l'alimentation électrique est réalisé par le biais d'un raccordement à courant alternatif de 230V/N/PE/50Hz.
- La protection par fusibles doit se faire avec un dispositif de protection par courant de défaut (RCD/ FI) avec un courant différentiel résiduel de maximum 30 mA.
- Si une liaison équipotentielle s'avère nécessaire, elle doit être faite par le client.
- Respecter les consignes VDE, nationale et EVU correspondantes, dans leur version en vigueur.
- La possibilité de séparation du secteur doit être garantie pour le produit et ce, soit par une fiche librement accessible, soit par une fiche multipolaire selon EN 60335-1 para. 24.3.



Montage: (voir pages 303)

- **Attention!** La robinetterie doit être installée, rincée et contrôlée conformément aux normes valables. (Installation selon EN 1717)
Voir les instructions de montage ::
Raindance Rainfall 28411000
Raindance Rainmaker 28403000 / 28404000 / 28417000 / 28418000
- Tous les travaux ne doivent être faits qu'à l'état hors tension.
- Le corps de base 15941180 ne peut être installé qu'à la verticale!
Montage avec bague de réglage (A) seulement possible dans la partie avant et centrale !
- Tous les éléments doivent rester accessibles.

Informations techniques:

Pression de service autorisée::	max. 1 MPa
Pression de service conseillée:	0,1 - 0,5 MPa
Pression maximum de contrôle::	1,6 MPa
(1 MPa = 10 bar = 147 PSI)	
Température d'eau chaude::	max. 80° C
Température recommandée:	65° C
Dimension d'arrivée:	G 3/4
Raccordement Alimentation:	Eau mélangée
Débit libre à 0,3 MPa:	
1 Consommateur:	35 l/min
2 Consommateur:	45 l/min



Accessoires: (voir pages 14)



Dimensions: (voir pages 292)



Exemples de montage Raindance Rainfall: (voir pages 295)



Exemples de montage Raindance Rainmaker: (voir pages 299)



Instructions de service: (voir pages 16)

- Lors d'une coupure de la tension de secteur 230 V, l'installation de douche ne peut pas être mise en service.
- Le produit n'est pas prévu pour une utilisation en liaison avec un bain à vapeur



Nettoyage filter: (voir pages 309)





























Pièces de rechange (voir pages 311)

Montage voir pages 303

Français Informations techniques

Dysfonctionnement	Origine	Solution
Aucune fonction	- Pas d'alimentation en tension - Transformateur du kit de base défaillant - Récepteur mal placé / défaillant - Émetteur pas initialisé / défaillant	- Assurer l'alimentation en tension - Remplacer le transformateur - Modifier la position du récepteur ou le remplacer - Initialiser / remplacer l'émetteur
Le mode de fonctionnement ne se laisse pas configurer	- Contact Reed pas en position convenable derrière la rosette - Contact Reed défaillant	- Placer le contact Reed sur la rosette - Remplacer le câble de raccord de l'électrovanne
Aucune fonction éclairage	- Transformateur Rainmaker pas branché / défaillant - Câbles d'alimentation du relais d'éclairage défectueux / défaillants	- Assurer l'alimentation en tension du transformateur ou le remplacer - Vérifier / remplacer les raccords et le relais d'éclairage
Les consommateurs se coupent d'eux-mêmes	- Durée de marche enregistrée en mode programmé	- Prolonger / couper la durée de marche en mode service
Robinetterie pas étanche	- Électrovanne encrassée / défaillante	- Nettoyer / remplacer la membrane de l'électrovanne
Débit trop faible	- Tamis encrassé du côté entrée	- Nettoyez / changez le filtre

Symboles

	Raccord d'eau DN 20 Eau chaude		transfo		Compensation de potentiel
	Raccord d'eau DN 20 Eau froide		Récepteur		tout éteint
	Ouvrir l'eau.		Fiche de codage		Lampes
	Couper l'arrivée d'eau		230V		Rain
	A partir de • le fonctionnement est garanti.		12V		Whirl
	Le débit de vidage doit être supérieur à 50 l/min.		Tube vide		Rainflow
	Vidage		Commande d'éclairage 27189000 (ne fait pas partie de la fourniture !)		Rain AIR XXL
	Raindrain		Relais de lampes Rainmaker		Rain AIR
	Centre cuvette de douche		transfo Rainmaker		Silicone (sans acide acétique!)
			Raccord de 12 V préinstallé par le client pour l'éclairage (80 W maxi)		

Montage voir pages 303

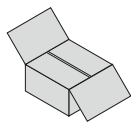

Français Accessoires

Transfo:

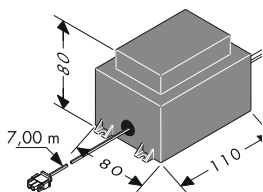

La puissance du transformateur externe est de 50 VA. Le transformateur doit être installé dans la zone sèche (zone de protection 3) Le transformateur peut être installé avec le récepteur dans un boîtier en plastique, en conformité avec les dispositions de la norme EN/CEI 60335-1. (dimensions env. 250 x 160 x 92 mm, non compris dans la livraison.) Le câble fourni permet l'installation du transformateur à une distance maximale de 7,00 m du récepteur. For this, you must provide an empty pipe EN35 (not included in the delivery). La gaine vide doit être fixée au moins tous les 500 mm, et le rayon de courbure doit être supérieur à 100 mm. Le câble secondaire du transformateur, d'une longueur approximative de 7,00 m, ne doit pas être

raccourci. La longueur de câble superflue doit être logée à proximité du transformateur de sécurité. Un câble de branchement endommagé ne doit pas être remplacé. Le transformateur ne pourra alors plus être utilisé. Un câble de branchement endommagé ne doit pas être remplacé. En cas de défaillance du câble de raccord au secteur, le câble doit être remplacé avec le transformateur par un électricien.

Relais de lampes:

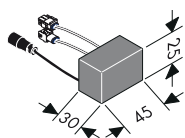

(seulement pour variantes avec éclairage intégré)
Le relais de lampes ne doit pas être soumis à plus de 12 V CA / 80 W.
Le fonctionnement sur le secteur de 230 V n'est pas autorisé.

Commande d'éclairage:

27189000

(ne fait pas partie de la fourniture)

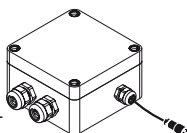

(iControl mobile 15944000)
Dans le cas des versions avec source lumineuse externe, la commande de l'éclairage doit être raccordée.
La commande d'éclairage doit être accessible à tout moment

Fiche de codage:

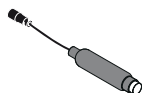

(Raindance Rainfall 28411000 / Raindance Rainmaker 28403000)
La fiche de codage doit être connectée sur les variantes sans lampes.
Lorsque le mode de service est activé sur les modèles sans lampes, le témoin lumineux de la fiche de codage indique les acquittements optiques.
La fiche de codage doit être accessible à tout moment.

Câble de raccordement îlot d'électrovannes / Câble de raccordement Lampes:



Le câble de l'îlot d'électrovannes, d'une longueur de 7,50 m, ainsi que le câble des lampes d'une longueur de 10,00 m ne peuvent pas être raccourcis. La longueur de câble superflue doit être logée à proximité du récepteur.
Le câble de l'îlot d'électrovannes et le câble des lampes doivent être posés dans la gaine supplémentaire fournie (EN 20).
La gaine vide doit être fixée au moins tous les 500 mm, et le rayon de courbure doit être supérieur à 100 mm.

Attention: Les gaines supplémentaires du câble de l'îlot d'électrovannes et du câble des lampes ne sont pas destinées à des câbles électriques qui acheminent une tension supérieure à 12 V.

Montage voir pages 303

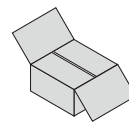

Récepteur:

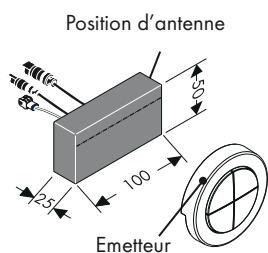

Il est préférable de monter le récepteur dans le même local que l'installation de douche.

Si cela n'est pas possible, le récepteur peut également être monté dans un local voisin de l'installation de douche.

Le récepteur ne doit pas être installé dans un boîtier métallique, car celui-ci bloquerait les signaux radio de l'émetteur. De plus, vous devez veiller à ce qu'il y ait le moins d'éléments métalliques possibles à proximité de l'emplacement de montage du r

Pour garantir la réception optimale des signaux

radio, l'antenne du récepteur sera si possible orientée vers l'émetteur.

Emetteur:



Lors de la livraison, l'émetteur est déjà réglé sur le récepteur. Grâce à des numéros de série identiques, l'émetteur peut être affecté au récepteur.

Des émetteurs supplémentaires ou installés ultérieurement doivent faire l'objet d'un apprentissage. Le nombre maximal d'émetteurs réglés ou mémorisés est de quatre. (voir pages 20/21 Mode enregistrement).

La fréquence radio de l'émetteur est de 868,3 MHz.

Remarque: Le récepteur et les émetteurs ont une portée d'env. 10,00 m. La portée dépend de l'importance de l'atténuation des signaux radio entre l'émetteur et le récepteur.

Remarque: Pour des raisons de sécurité, n'utiliser l'émetteur que dans le champ de vision de la douche. Sinon, l'eau pourrait se déclencher par inadvertance.

Remarque: Mode opératoire correct pour le remplacement d'un émetteur défectueux par un émetteur neuf :

1. Supprimer tous les émetteurs. (Mode enregistrement ⇒ Mode suppression).
2. Effectuer l'apprentissage de tous les émetteurs, en dehors de l'émetteur défectueux. (Mode Service ⇒ Mode enregistrement).

Matériau	Atténuation
Bois, plâtre, verre (sans revêtement, sans métal)	0 - 10 %
Briques, panneaux d'aggloméré	5 - 35 %
Béton armé à l'acier	10 - 90 %
Métal, habillages en aluminium	90 - 100 %

Aimant:



Pour activer le mode service, il faut que l'aimant actionne le contact REED (derrière La rosette) (voir pages 18/19, Mode Service).

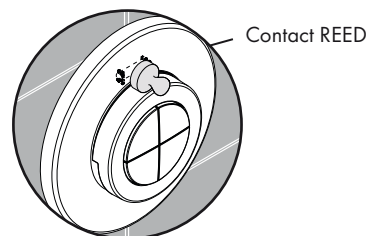

Français
Instructions de service

Raindance Rainfall

28411000

iControl mobile

15940180 / 15942000

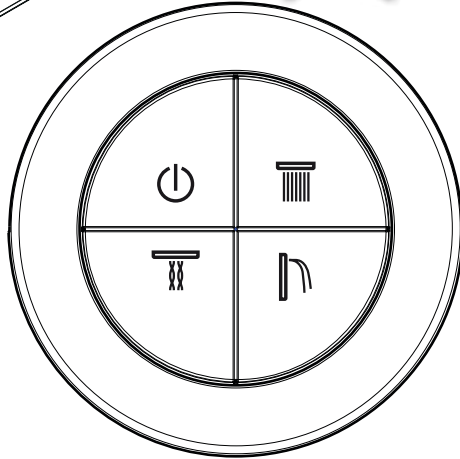
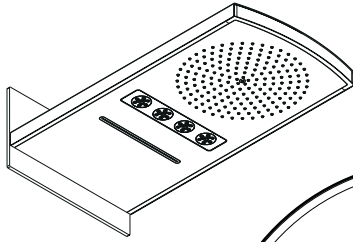

Raindance Rainfall

28411000

iControl mobile

15941180 / 15944000

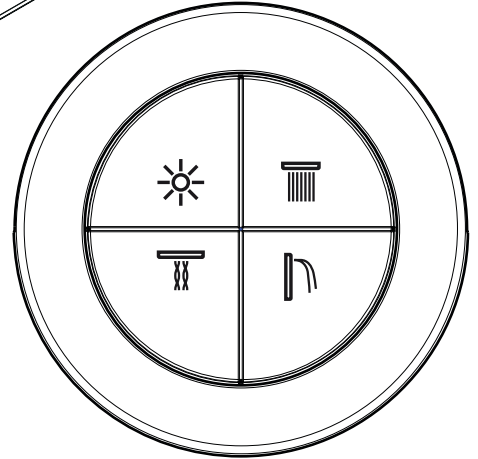
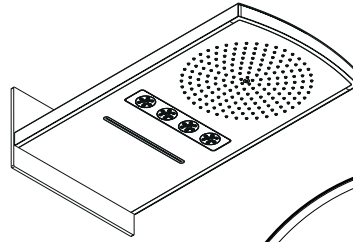

Raindance Rainmaker

28403000

iControl mobile

15940180 / 15943000

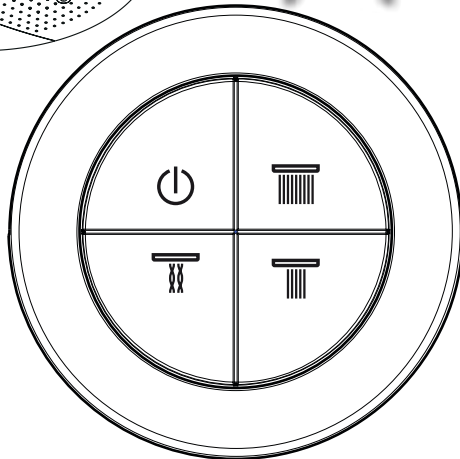
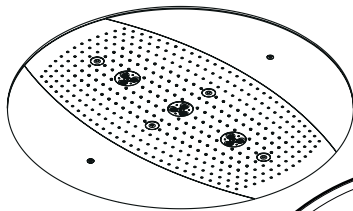

Raindance Rainmaker

28404000

iControl mobile

15941180 / 15945000

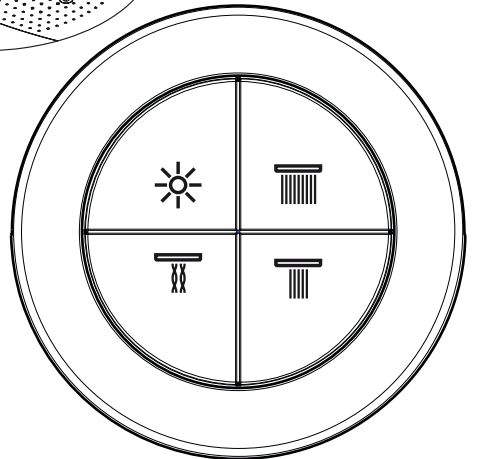
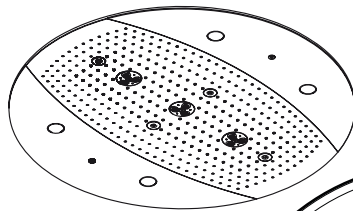

tout éteint



Rain



Whirl



Rainflow



Lampes



Rain AIR XXL



Rain AIR

Montage voir pages 303

Activer et désactiver les buses et les lampes:

(Fonctionnement standard avec lampes)

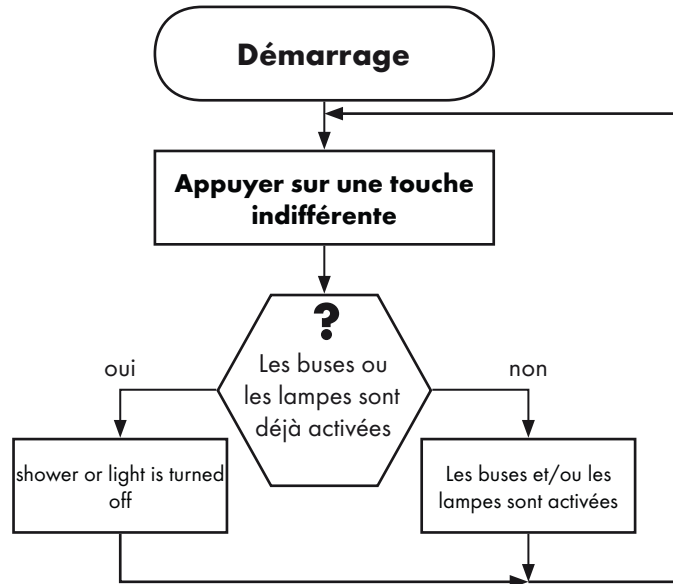

Activer et désactiver les buses :

(Fonctionnement standard sans lampes)

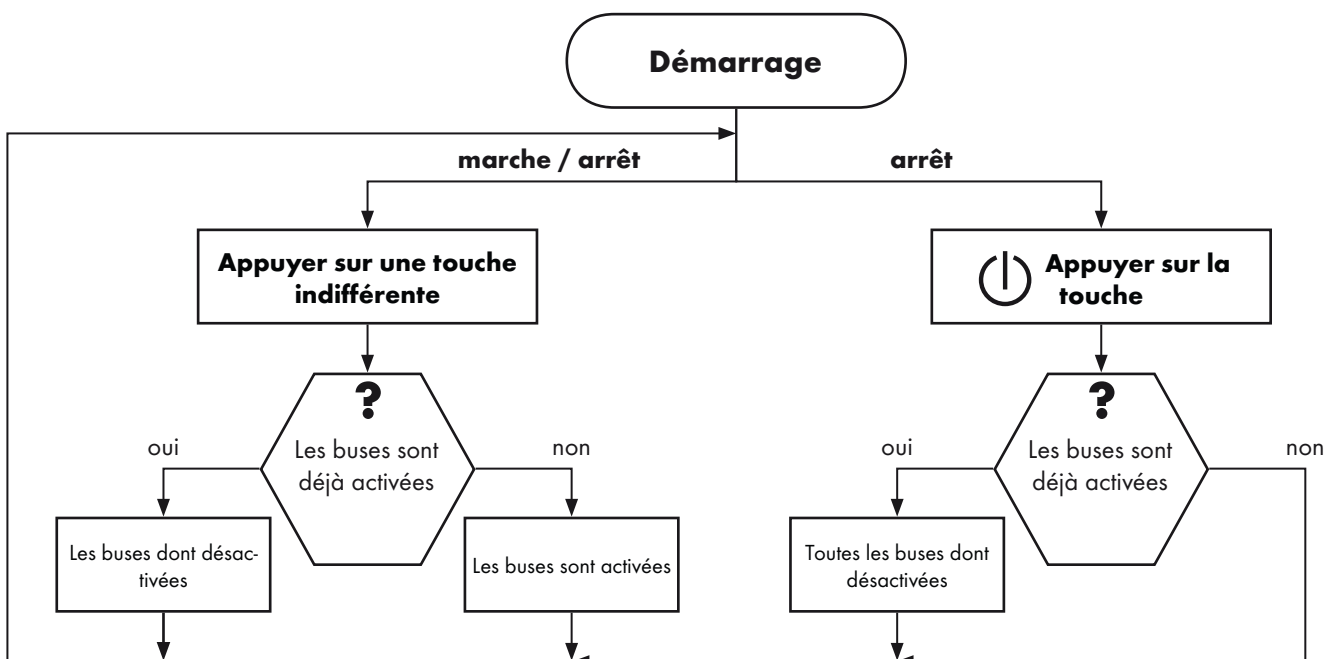

Montage voir pages 303

Français Plan opérateur

Raindance Rainfall
28411000

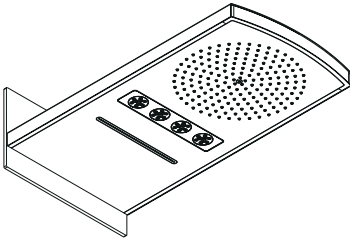

Mode exploitation

Remarque:
Toutes les buses doivent être désactivées



Mode Service

Remarque:
Lampes / fiche de codage clignote 4 x

Remarque:
Lampes / fiche de codage clignote 2 x

Remarque:
Lampes / fiche de codage s'éteint

< 15 sek.

> 15 sek.

Double-cliquer sur la touche ou

Double-cliquer sur la touche

Mode durée de fonctionnement maximale

Remarque:
Lampes / fiche de codage clignote par séquences de 1 sec.

Mode buses

Remarque:
Lampes / fiche de codage clignote par séquences de 2 sec.

< 15 sek.

> 15 sek.

< 15 sek.

> 15 sek.

Appuyer sur la touche

Appuyer sur la touche

Appuyer sur la touche

Appuyer sur la touche

Appuyer sur la touche

Appuyer sur la touche

Durées de fonctionnement :
Buses: 30 s
Lampes: 30 min

Standard: Durées de fonctionnement:
Buses: 60 s
Lampes: 30 min

Durées de fonctionnement ::
Buses: 180 s
Lampes: 30 min

Durées de fonctionnement :
Buses + lampes : infini

Standard
2 buses tout au plus peuvent être activées

Confort 1:
Toutes les buses peuvent être activées simultanément

Français Plan opérateur

Raindance Rainmaker
28403000 / 28404000

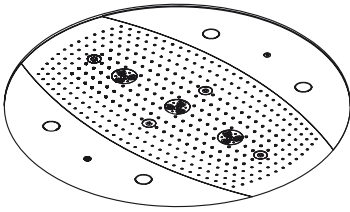

Mode exploitation

Remarque:
Toutes les buses doivent être désactivées



Mode Service

Remarque:
Lampes / fiche de codage clignote 4 x

Remarque:
Lampes / fiche de codage clignote 2 x

Remarque:
Lampes / fiche de codage s'éteint

< 15 sek.

> 15 sek.

Double-cliquer sur la touche ou

Double-cliquer sur la touche

Mode durée de fonctionnement maximale

Remarque:
Lampes / fiche de codage clignote par séquences de 1 sec.

Mode buses

Remarque:
Lampes / fiche de codage clignote par séquences de 2 sec.

< 15 sek.

> 15 sek.

< 15 sek.

> 15 sek.

Appuyer sur la touche

Appuyer sur la touche

Appuyer sur la touche

Appuyer sur la touche

Appuyer sur la touche

Appuyer sur la touche

Appuyer sur la touche

Durées de fonctionnement :
Buses: 30 s
Lampes: 30 min

Standard: Durées de fonctionnement:
Buses: 60 s
Lampes: 30 min

Durées de fonctionnement ::
Buses: 180 s
Lampes: 30 min

Durées de fonctionnement :
Buses + lampes : infini

Standard
2 buses tout au plus peuvent être activées

Confort 1:
Toutes les buses peuvent être activées simultanément

Confort 2:
Quantité d'eau plus importante, possible uniquement sur Rainmaker

Français Plan expert

Raindance Rainfall
28411000

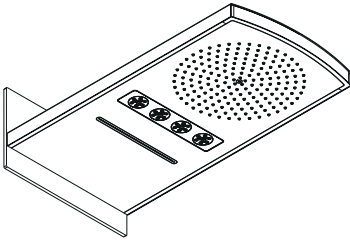

Mode exploitation

Remarque:
Toutes les buses doivent être désactivées



Mode Service

Remarque:
Lampes / fiche de codage clignote 4 x

Remarque:
Lampes / fiche de codage s'éteint

Remarque:
Lampes / fiche de codage clignote 4 x / 2x

< 15 sek.

> 15 sek.

Appuyer 1 x sur une touche indifférente

Double-cliquer sur la touche

Double-cliquer sur la touche

Mode enregistrement

Mode suppression

Mode présentation

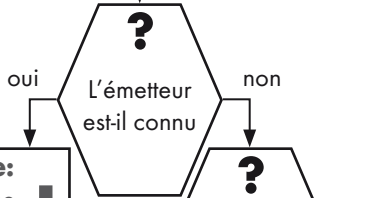

Remarque:
Lampes / fiche de codage clignote par séquences de 0,5sec.

Remarque:
Lampes / fiche de codage clignote par séquences de 4 sec.

Remarque:
Lampes / fiche de codage clignote 1x

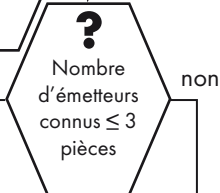

Remarque:
Le plus ancien émetteur connu est supprimé

< 15 sek.

> 15 sek.

< 15 sek.

> 15 sek.

Appuyer sur la touche

Appuyer sur la touche

Appuyer sur la touche

Appuyer sur la touche

Appuyer sur la touche

Tous les émetteurs sont supprimés

L'émetteur utilisé est supprimé

La présentation 1 est démarrée

La présentation 2 est démarrée

La présentation 3 est démarrée

Remarque:
Lampes / fiche de codage clignote 3x
Un nouvel émetteur est réglé ou mémorisé

Appuyer sur une touche indifférente
Remarque:
Toutes les buses se désactivent

Français Plan expert

Raindance Rainmaker
28403000 / 28404000

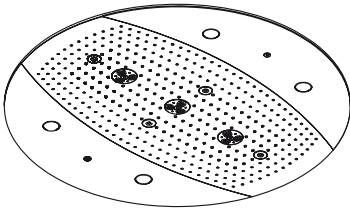

Mode exploitation

Remarque:
Toutes les buses doivent être désactivées



Mode Service

Remarque:
Lampes / fiche de codage clignote 4 x

Remarque:
Lampes / fiche de codage clignote 4 x / 2x

Remarque:
Lampes / fiche de codage s'éteint

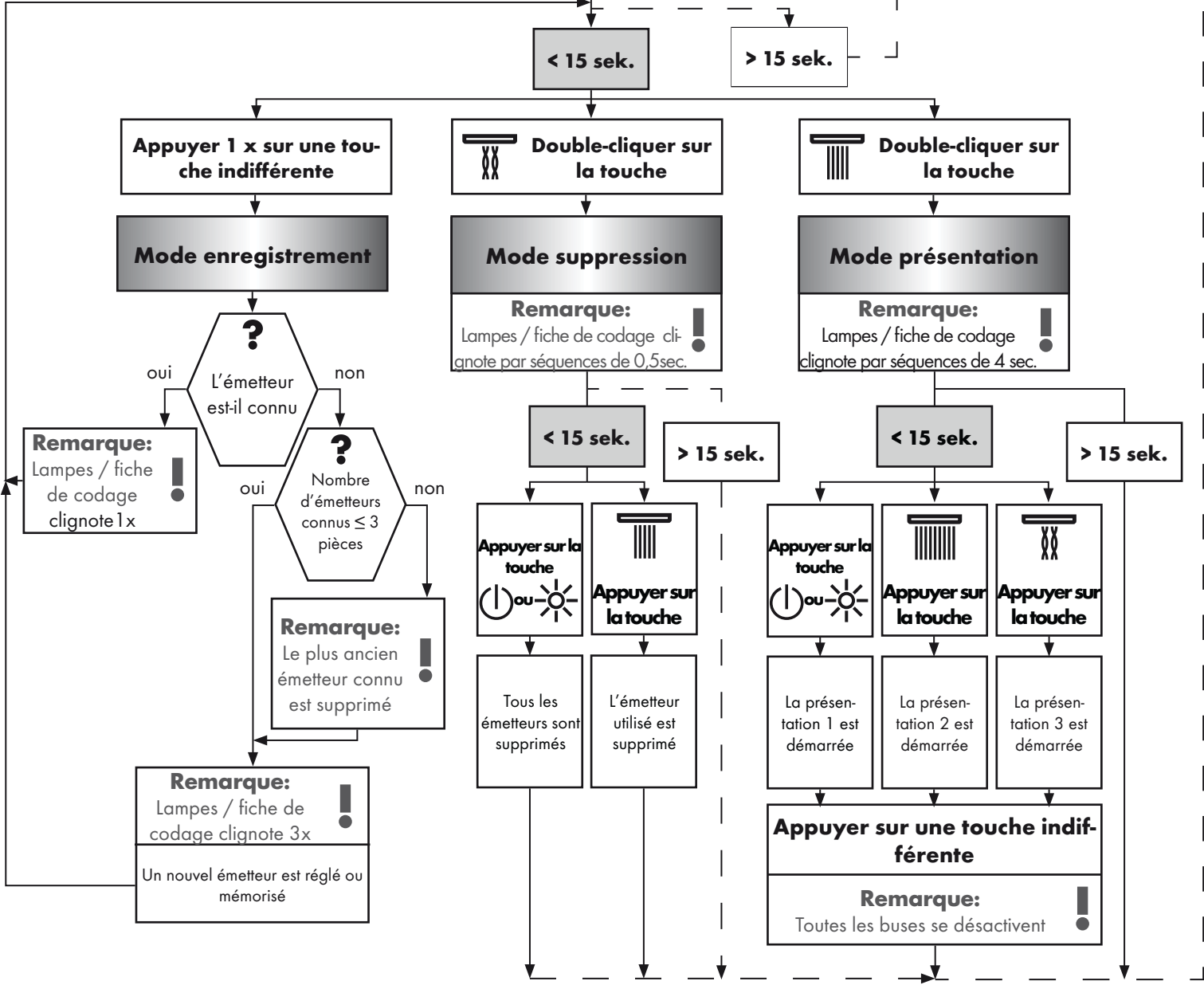

Standards and guidelines:

The use of the product is warranted by the following guidelines:

- EN 15200
- EN 60335-2-105



Safety Notes:

- The shower system may only be used for bathing, hygienic and body cleansing purposes.
- Children must not use the shower system without supervision.
- Children as well as adults with physical, mental and/or sensoric impairments must not use this shower system without proper supervision. Persons under the influence of alcohol or drugs are prohibited from using this shower system.
- Do not allow the streams of the shower touch sensitive body parts (such as your eyes). An adequate distance must be kept between the shower and you.
- The hot and cold supplies must be of equal pressures.



Electrical connection:

- The installation and testing work must be performed by a skilled electrician in observance of VDE 0100 part 701 and IEC 60364-7-701.
- Only one socket is required for the electrical connection. The power is supplied via an external transformer.
- No easily inflammable material is allowed in the immediate vicinity.
- The ambient temperature must not be higher than 50°C.
- The entire power is supplied via a 230V/N/PE/50Hz AC connection.
- The system must be protected via a leakage current protective device (RCD/ FI) with a measurement difference current of ≤ 30 mA.
- If a potential equalisation is required, this must be done on site.
- The current version of the applicable regulations from VDE, local authorities and utility companies must be observed for electric installation work.
- It must be ensured that the product can be disconnected from the mains. Either via a freely accessible plug or via an all-pin switch as per EN 60335-1, sect. 24.3



Assembly: (see page 303)

- **Important!** The fitting must be installed, flushed and tested after the valid norms. (Installation to EN 1717)
See installation instructions:
Raindance Rainfall 28411000
Raindance Rainmaker 28403000 / 28404000 / 28417000 / 28418000
- Any work may only be carried out in a de-energized state.
- The basic body 15941180 can only be installed vertically!
Installation with adjustment ring (A) only possible in the front and middle sections!
- All components must remain accessible.

Technical Data:

Operating pressure::	max. 1 MPa
Recommended operating pressure:	0,1 - 0,5 MPa
Test pressure::	1,6 MPa
(1 MPa = 10 bar = 147 PSI)	
Hot water temperature::	max. 80° C
Recommended hot water temp.:	65° C
Centre distance:	G ¾
Connections Input:	Water mixture
Rate of flow by 0,3 MPa:	
1 Consumer:	35 l/min
2 Consumer:	45 l/min



Fittings: (see page 24)



Dimensions: (see page 292)



Installation example Raindance Rainfall: (see page 295)



Installation example Raindance Rainmaker: (see page 299)



Operation: (see page 26)

- If there is a power failure of the 230 V mains power, the showers will not function.
- The product is not designed to be used with steam baths!



Cleaning filter: (see page 309)

Spare parts (see page 311)

Assembly see page 303

English Technical Information

Fault	Cause	Remedy
No function at all	<ul style="list-style-type: none"> - No voltage supply - Transformer of basic set defective - Receiver placed unfavourably / defective - Transmitter not taught-in / defective 	<ul style="list-style-type: none"> - Ensure voltage supply - Replace transformer - Change location of receiver or replace receiver - Teach-in transmitter / replace
Operating mode cannot be configured	<ul style="list-style-type: none"> - Reed contact not in proper position behind the rosette - Reed contact faulty 	<ul style="list-style-type: none"> - Place Reed contact on the rosette - Replace connecting line to the solenoid valve
No light function	<ul style="list-style-type: none"> - Transformer of Rainmaker / faulty - Supply lines for the light relay faulty / defective 	<ul style="list-style-type: none"> - Ensure voltage supply to transformer / replace transformer - Check the connections and the light relay / replace
Consumers shut off on their own	<ul style="list-style-type: none"> - Runtime saved in programme mode 	<ul style="list-style-type: none"> - Extend / switch off trailing time in service mode
Fixture leaks	<ul style="list-style-type: none"> - Solenoid valve contaminated / defective 	<ul style="list-style-type: none"> - Clean / replace solenoid valve membrane
Flow too low	<ul style="list-style-type: none"> - Dirt collecting sieve on the input side contaminated 	<ul style="list-style-type: none"> - Clean the filter / exchange filter

Symbols

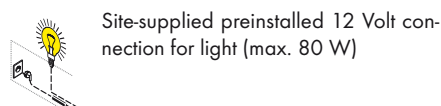
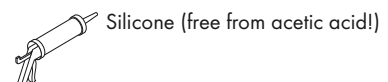
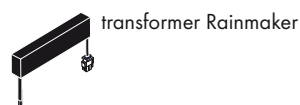
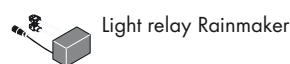
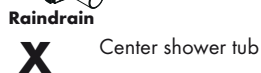
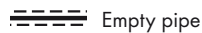
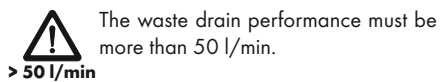
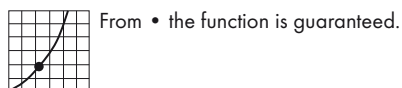
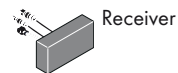
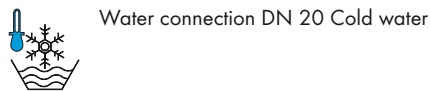
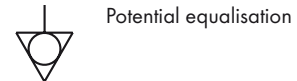
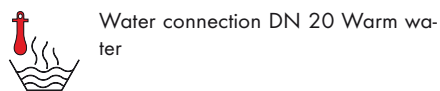

Assembly see page 303

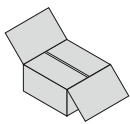

English Fittings

Transformer:

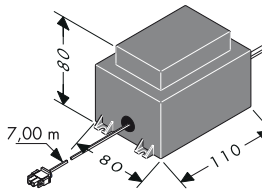

The external transformer provides 50 VA. The transformer must be installed in the dry area (protected zone 3). The transformer can be installed together with the receiver in a plastic housing, while observing EN/IEC 60335-1. (dimensions approx. 250 x 160 x 92 mm, not included in the delivery.) The included cable allows the installation of the transformer, up to 7 m away from the receiver. For this, you must provide an empty pipe EN35 (not included in the delivery). This empty pipe must be affixed at least every 500 mm and the bending radius must be greater than 100 mm. The secondary line of the transformer, which is approx 7 m long, must not be shortened. The unused line length should be stored near the safety

transformer. A damaged connecting line must not be replaced. The transformer may no longer be used.

A damaged connecting line must not be replaced. In case of a defective mains cable, the entire cable including the transformer must be replaced by a trained electrician.

Light relay:

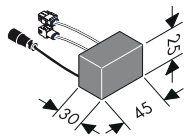

(for models with integrated lights only)

The max. load for the light relay is 12 V AC / 80 W.

Do not use with 230 V power.

Light control:

27189000

(order as an extra)

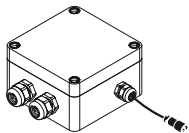

(iControl mobile 15944000)

On the models with external light source, the light control must be connected. The light control must be accessible at any time.

Coding plug:

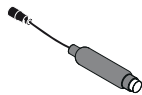

(Raindance Rainfall 28411000 / Raindance Rainmaker 28403000)

The coding plug must be connected on the models without light.

If the service mode is activated on models without light, the LED of the coding plug will display the visual return messages.

The coding plug must remain accessible.

Connecting line Solenoid valve block / Connecting line Light:



The solenoid valve block line (7.50 m) and the light cable (10.00 m) may not be shortened. The excess cable length should be stored near the receiver. The solenoid valve block line and the light cable may only be routed in the enclosed empty pipe (EN 20).

This empty pipe must be affixed at least every 500 mm and the bending radius must be greater than 100 mm.

Important: No electrical lines carrying a voltage of more than 12 V may be routed in the empty pipes for the solenoid valve block line and the light cable.

Assembly see page 303

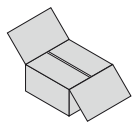

Receiver:

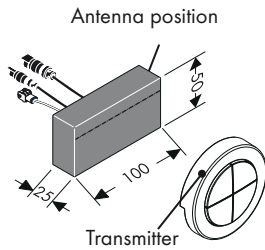

The receiver should be installed in the same room as the shower system.

If this is not possible, the receiver can also be installed in a room adjacent to the shower system. The receiver must not be installed inside a metal housing, as this would prevent it from receiving the radio signals of the transmitter. Furthermore, you must make sure that there are as few shielding metal parts present in the vicinity of the receiver.

The receiver antenna should be facing the transmitter to optimally detect the radio signals.

Transmitter:



The transmitter is already trained to the receiver when the parts are delivered. The transmitter can be allocated to the receiver based on their identical serial numbers.

Additional transmitters or those purchased later, must be trained. A maximum of four transmitters can be trained or saved. (see page 30/31 Login mode).

The radio frequency of the transmitter is 868.3 MHz.

Note: The receiver and the transmitter have a range of approx. 10 m. This range depends on how strongly the radio signals are dampened between the transmitter and the receiver.

Note: For safety reasons, use the transmitter only in the visual area of the shower system. Otherwise, the water may be turned on accidentally.

Note: Correct procedure to replace a defective transmitter with a new one:

1. Delete all transmitters. (Login mode ⇒ Delete mode).
2. Retrain all transmitters except for the defective one. (Service mode ⇒ Login mode).

Material	Damping
Wood, gypsum, glass (uncoated, without metal)	0 - 10 %
Brick, particle board plates	5 - 35 %
Concrete with iron reinforcement	10 - 90 %
Metal, aluminium lamination	90 - 100 %

Magnet:



In order to activate the service mode, the magnet must actuate the REED contact (behind the rosette). (see page 28/29 Service mode).

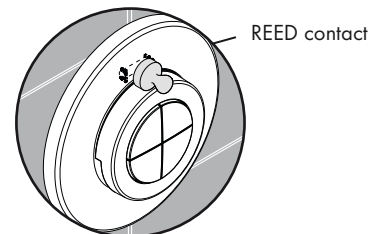

English Operation

Raindance Rainfall

28411000

iControl mobile

15940180 / 15942000

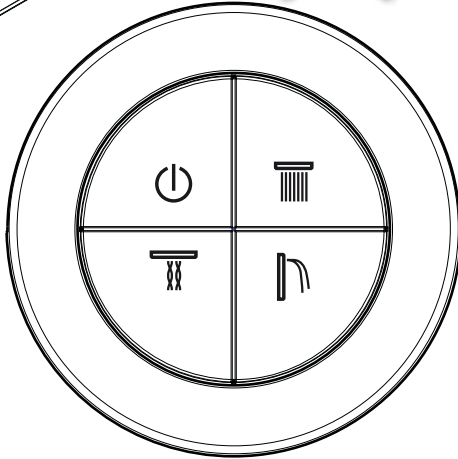
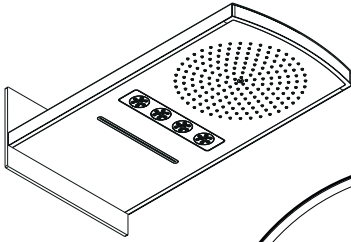

Raindance Rainfall

28411000

iControl mobile

15941180 / 15944000

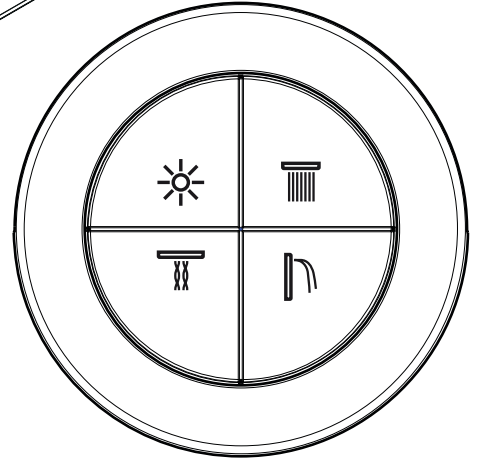
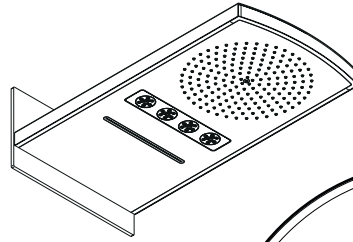

Raindance Rainmaker

28403000

iControl mobile

15940180 / 15943000

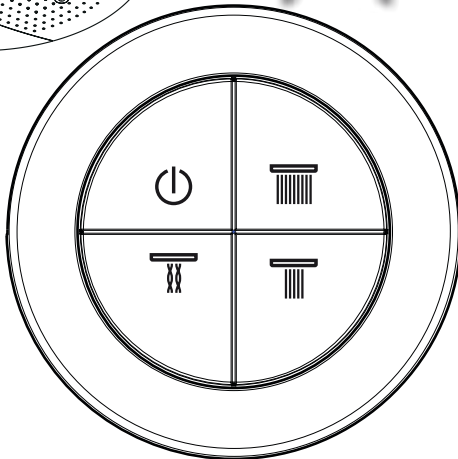
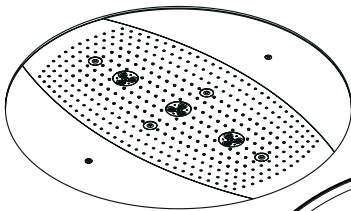

Raindance Rainmaker

28404000

iControl mobile

15941180 / 15945000

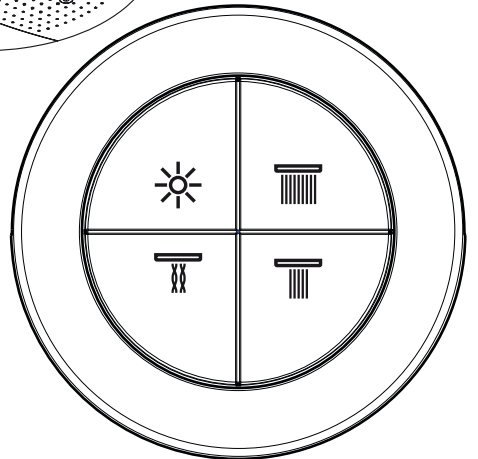
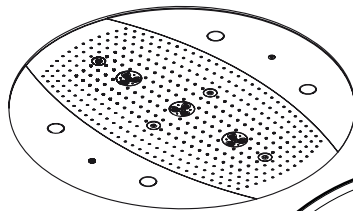

everything off



Rain



Whirl



Rainflow



Light



Rain AIR XXL



Rain AIR

Assembly see page 303

Turn showers and light on and off:

(Fonctionnement standard avec lampes)

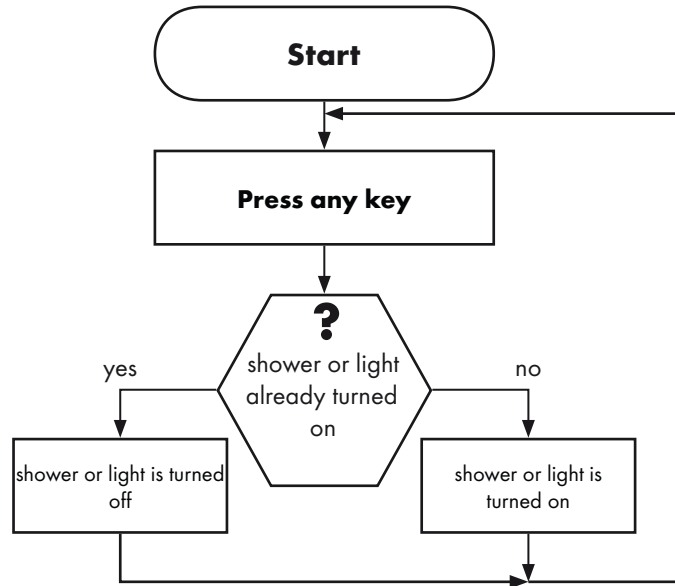

Turn the showers on and off:

(Standard function without light)

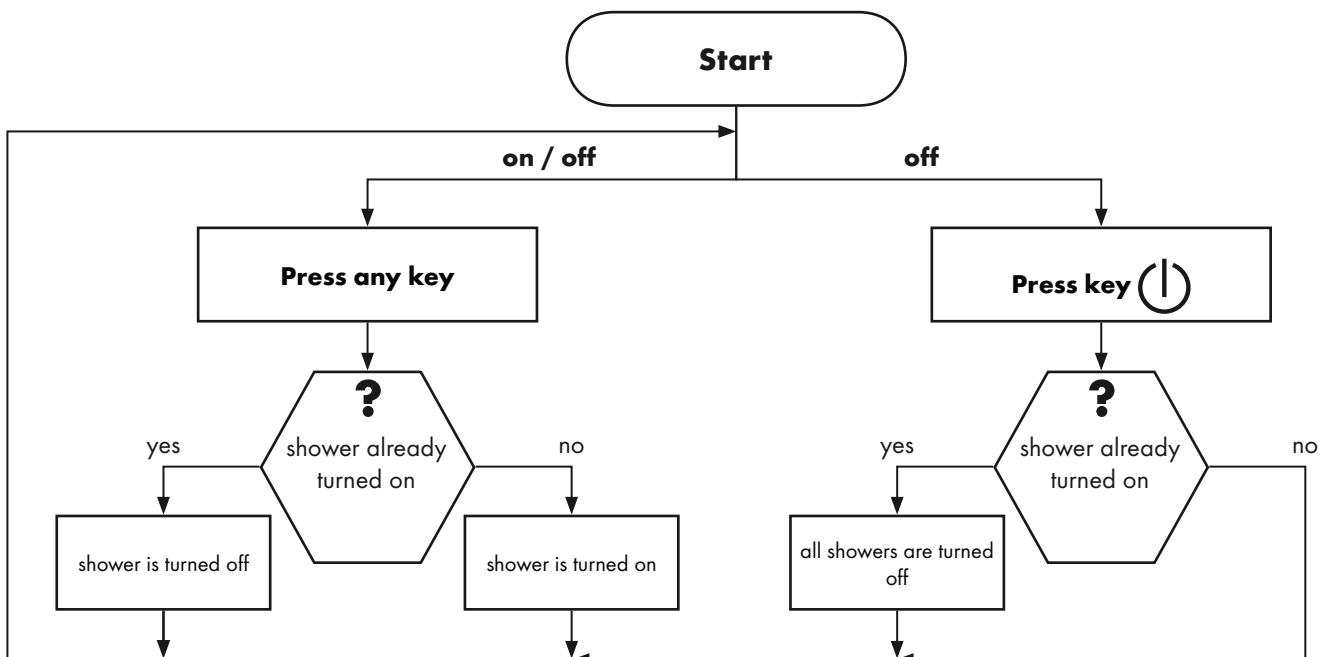

Assembly see page 303

English User level

Raindance Rainfall
28411000

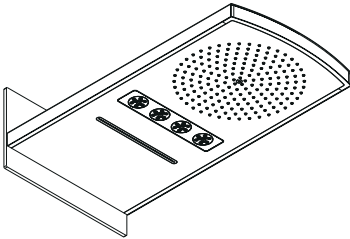

Operating mode

Note:
All showers must be turned off

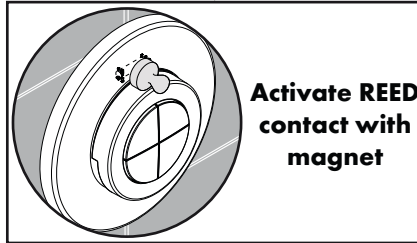

Service mode

Note:
Light / coding plug blinks 4 x

Note:
Light / coding plug shuts off

Note:
Light / coding plug blinks 2x

< 15 sek.

> 15 sek.

Double-click on
⏻ or ☀️ key

Double-click on key

Maximum run time mode

Shower mode

Note:
Light / coding plug blinks in 1 sec. rhythm

Note:
Light / coding plug blinks in 2 sec. rhythm

< 15 sek.

> 15 sek.

< 15 sek.

> 15 sek.

Press or key ⏻ ☀️

Press key 🚿

Press key 🚿

Press key 🚿

Press or key ⏻ ☀️

Press key 🚿

Run times:
showers: 30 s
Light: 30 min

Standard:
Run times:
showers: 60 s
Light: 30 min

Run times:
showers: 180 s
Light: 30 min

Run times:
showers + light
infinite

Standard
A max. of 2 showers can be turned on

Comfort 1:
All showers can be turned on at the same time

English
User level

Raindance Rainmaker
28403000 / 28404000

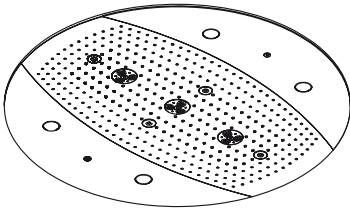

Operating mode

Note:
All showers must be turned off



Service mode

Note:
Light / coding plug blinks 4 x

Note:
Light / coding plug blinks 2x

Note:
Light / coding plug shuts off

< 15 sek.

> 15 sek.

Double-click on
⏻ or ☀️ key

Double-click on key



Maximum run time mode

Note:
Light / coding plug blinks in 1 sec. rhythm

Shower mode

Note:
Light / coding plug blinks in 2 sec. rhythm

< 15 sek.

> 15 sek.

< 15 sek.

> 15 sek.

Press or key



Press key



Press key



Press key



Press or key



Press key



Press key



Run times:
showers: 30 s
Light: 30 min

Standard:
Run times:
showers: 60 s
Light: 30 min

Run times:
showers: 180 s
Light: 30 min

Run times:
showers + light
infinite

Standard
A max. of 2 showers can be turned on

Comfort 1:
All showers can be turned on at the same time

Comfort 2:
Larger water volume, only required for Rainmaker

English Expert level

Raindance Rainfall
28411000

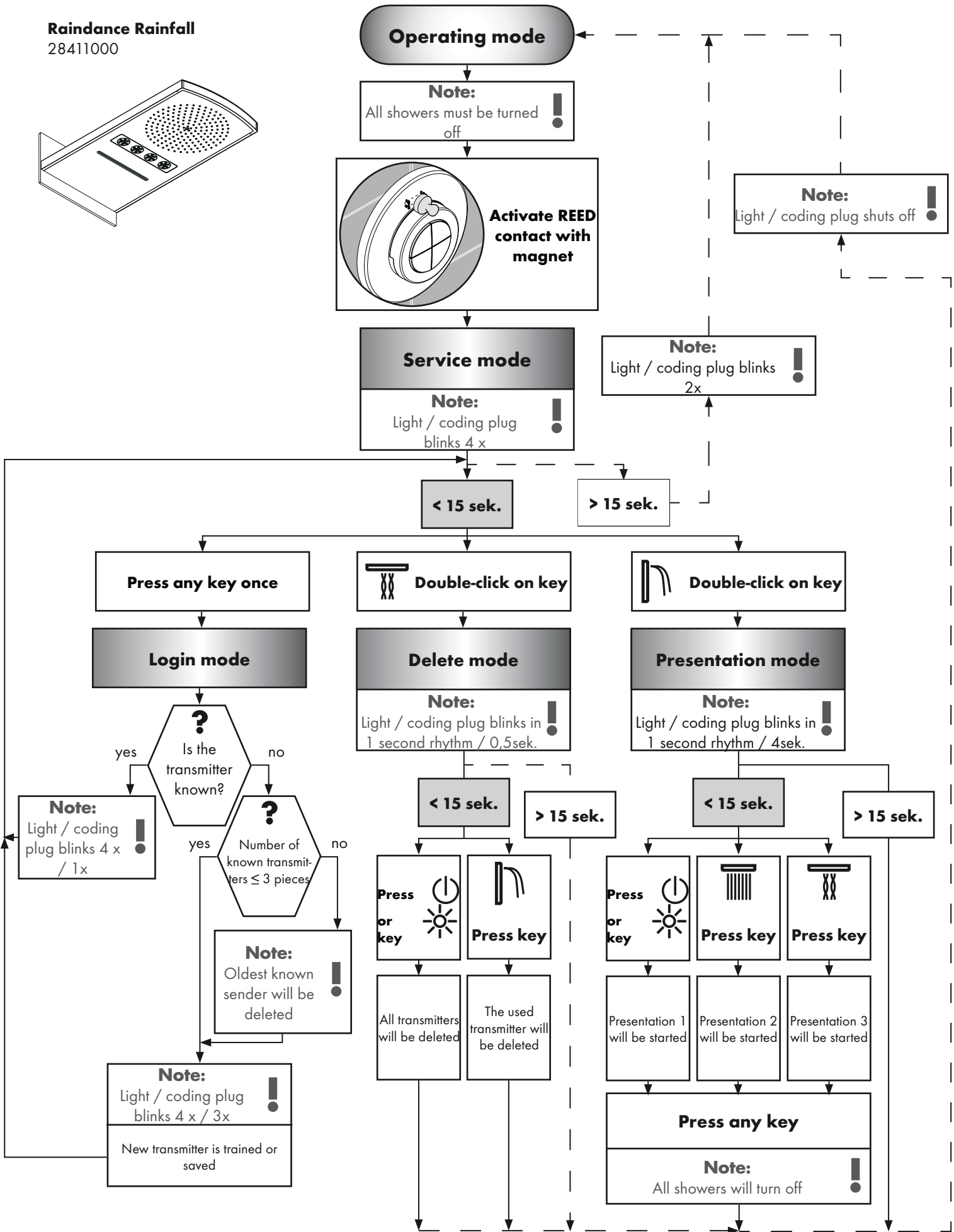
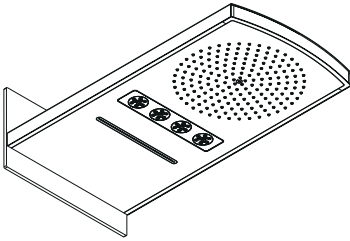

English Expert level

Raindance Rainmaker
28403000 / 28404000

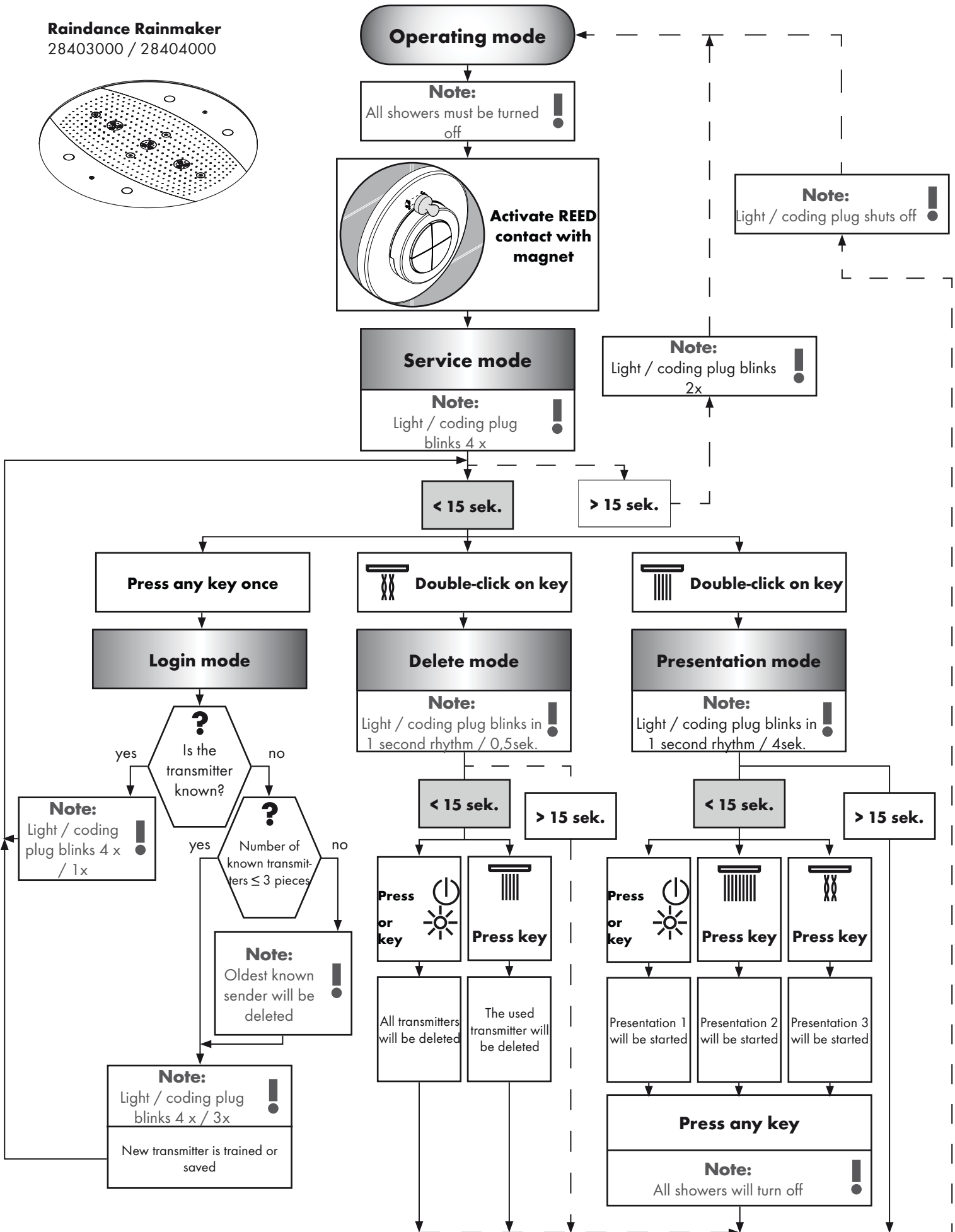
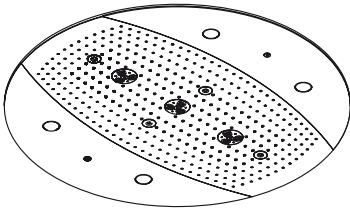

Norme e direttive:

L'impiego del prodotto è garantito dalle direttive seguenti:

- EN 15200
- EN 60335-2-105



Indicazioni sulla sicurezza:

- Il sistema doccia deve essere utilizzato esclusivamente per l'igiene del corpo.
- Non lasciare utilizzare il sistema doccia da bambini insorvegliati.
- I bambini e gli adulti affetti da menomazioni fisiche, psichiche e/o sensoriali devono utilizzare il sistema della doccia solo sotto la supervisione di una persona responsabile.
- Bisogna evitare il contatto fra il getto della doccia e parti del corpo delicate (ad es. gli occhi). Fra il soffione ed il corpo va mantenuta una distanza sufficiente.
- Attenzione! Compensare le differenze di pressione tra i collegamenti dell'acqua fredda e dell'acqua calda.



Allacciamento elettrico:

- I lavori di installazione e di controllo vanno eseguiti da un elettricista specializzato autorizzato, in considerazione della normativa VDE 0100 Parte 701 e IEC 60364-7-701.
- Per il collegamento elettrico si ha bisogno solo di una presa. L'alimentazione della corrente avviene attraverso un trasformatore esterno.
- Nelle vicinanze dirette non deve trovarsi nessun materiale facilmente infiammabile.
- La temperatura ambiente non deve essere maggiore di 50 °C.
- L'alimentazione completa della corrente avviene attraverso un collegamento di corrente alternata 230V/N/PE/50Hz.
- Per protezione bisogna installare un circuito di sicurezza per correnti di guasto (RCD/ FI) con una corrente differenziale nominale di ≤ 30 mA.
- Se è necessario una compensazione di potenziale, questa deve essere creata da parte del cliente.
- Per l'installazione elettrica vanno rispettate le corrispondenti prescrizioni VDE, del Paese e EVU nella rispettiva versione valida.
- Deve essere garantito che il prodotto possa essere separato dalla rete elettrica. Questo può essere realizzato tramite una spina liberamente accessibile oppure tramite un interruttore passatutto secondo EN 60335-1 cv. 24.3.



Montaggio: (vedi pagg. 303)

- **Attenzione!** La rubinetteria deve essere installata, pulita e testata secondo le istruzioni riportate! (Installazione secondo la norma EN 1717)
Vedi le istruzioni di montaggio:
Raindance Rainfall 28411000
Raindance Rainmaker 28403000 / 28404000 / 28417000 / 28418000
- Tutti i lavori devono essere eseguiti solo in stato privo di tensione.
- Il corpo base 15941180 può essere installato soltanto in verticale! Montaggio con anello di regolazione (A) possibile solo nella zona anteriore e centrale!
- Tutte le componenti devono rimanere accessibili.

Dati tecnici:

Pressione d'uso::	max. 1 MPa
Pressione d'uso consigliata:	0,1 - 0,5 MPa
Pressione di prova::	1,6 MPa
(1 MPa = 10 bar = 147 PSI)	
Temperatura dell'acqua calda::	max. 80° C
Temp. dell'acqua calda consigliata:	65° C
Distanza di raccordo:	G 3/4
Raccordi Entrata:	Acqua miscelata
Portata a 0,3 MPa:	
1 Utenza:	35 l/min
2 Utenza:	45 l/min



Accessori: (vedi pagg. 34)



Ingombri: (vedi pagg. 292)



Esempio di installazione Raindance Rainfall: (vedi pagg. 295)



Esempio di installazione Raindance Rainmaker: (vedi pagg. 299)



Procedura: (vedi pagg. 36)

- In caso di assenza della tensione di rete di 230 V il dispositivo doccia non può essere messo in funzione.
- Il prodotto non è predisposto per l'impiego in combinazione con un bagno a vapore.



Pulitura filtro: (vedi pagg. 309)

Ricambi (vedi pagg. 311)





























Montaggio vedi pagg. 303

Italiano

Informazioni tecniche

Problema	Possibile causa	Rimedio
Nessuna funzione	- nessuna alimentazione di tensione - Trasformatore elemento base difettoso - Ricevitore piazzato sfavorevole / difettoso - Trasmettitore non autoprogrammato / difettoso	- Assicurare l'alimentazione della tensione - Sostituire il trasformatore - Cambiare la posizione del ricevitore e/o sostituire il ricevitore - Autoprogrammare / sostituire il trasmettitore
Impossibile configurare il modo operativo	- Contatto Reed non nella posizione idonea dietro la rosetta - Contatto Reed difettoso	- Piazzare il contatto Reed alla rosetta - Sostituire il cavo di allacciamento dell'elettrovalvola
Nessuna funzione luce	- Trasformatore Rainmaker non collegato / difettoso - Cavi di alimentazione relè luce errato / difettoso	- Assicurare l'alimentazione del trasformatore / sostituire il trasformatore - Controllare / sostituire i collegamenti e relè luce
Le utenze si disattivano autonomamente	- Tempo di durata non salvato nel modo di programmazione	- Prolungare / disattivare il tempo d'inerzia nel modo di servizio
Valvolame non ermetica	- Elettrovalvola sporca / difettosa	- Pulire / sostituire la membrana dell'elettrovalvola
Portata / flusso insufficiente	- Filtro su lato entrata intasato	- Pulire / sostituire il filtro

Simboli

	Allacciamento acqua DN 20 Acqua calda		trasformatore		Compensazione di potenziale
	Allacciamento acqua DN 20 Acqua fredda		Ricevitore		Tutto OFF
	Aprire l'acqua		spina codificata		Luce
	Chiudere l'acqua		230V		Rain
	Dal • si garantisce la funzionalità.		12V		Whirl
	La portata di scarico deve essere superiore a 50 l/min.		Tubo vuoto		Rainflow
	Scarico		Comando luci 27189000 (non nel volume di fornitura!)		Rain AIR XXL
	Raindrain		Relè luce Rainmaker		Rain AIR
	Centro piatto doccia		trasformatore Rainmaker		Silicone (esente da acido acetico!)
			collegamento 12 V per la luce preinstallato dal cliente (80 W max.)		

Montaggio vedi pagg. 303

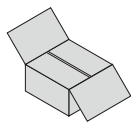

Italiano Accessori

trasformatore:

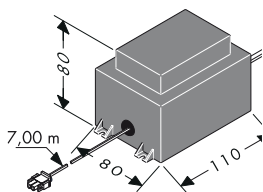

La potenza del trasformatore esterno è di 50 VA. Il trasformatore va installato in ambito asciutto (Zona di protezione 3). Il trasformatore può essere installato insieme al ricevitore in una scatola di plastica, considerando la normativa EN/IEC 60335-1. (dimensioni circa 250 x 160 x 92 mm, non appartiene al volume di fornitura.) Il cavo fornito insieme permette l'installazione del trasformatore fino a 7,00 m di distanza dal ricevitore. A tal proposito deve essere previsto un tubo vuoto EN35 (non appartiene al volume di fornitura). Il tubo vuoto va fissato almeno ogni 500 mm e il raggio curvato deve essere maggiore di 100 mm. Non accorciare il cavo secondario lungo circa 7,00 m del trasformatore. La lunghezza del cavo

non necessaria dovrebbe essere collocata nelle vicinanze del trasformatore di sicurezza. Un cavo di collegamento danneggiato non deve essere sostituito. In questo caso il trasformatore non deve essere fatto più funzionare.

Un cavo di collegamento danneggiato non deve essere sostituito. Nel caso di un difetto nel cavo di allacciamento alla rete elettrica il cavo stesso, completo del trasformatore, deve essere sostituito da un elettricista specializzato.

Relè luce:

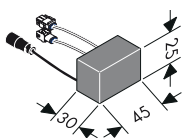

(solo per modelli con luce integrata)

Il relè luce deve essere caricato al massimo con 12 V CA / 80 W.

Non è permesso il funzionamento alla rete di 230 V.

Comando luci:

27189000

(non contenuto nel volume di fornitura)

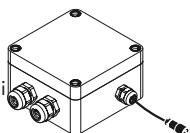

(iControl mobile 15944000)

Nei modelli con fonte di luce esterna si deve collegare il comando luce. Il comando luce deve essere sempre accessibile.

spina codificata:

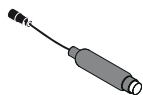

(Raindance Rainfall 28411000 / Raindance Rainmaker 28403000)

La spina codificata deve essere collegata per le varianti senza luce.

Se per le varianti senza luce è attivata la modalità Servizio, il LED della spina codificata indica la segnalazione di ritorno ottica.

Lo spinotto per la codificazione deve essere sempre accessibile

Cavo di collegamento Blocco di elettrovalvole / Cavo di collegamento Luce:



Non accorciare il cavo lungo 7,50 m del blocco di elettrovalvole e il cavo luce lungo 10,00 m. La lunghezza cavo non necessaria dovrebbe essere collocata nelle vicinanze del ricevitore.

Il cavo del blocco di elettrovalvole e il cavo luce devono essere posati solo nel tubo vuoto fornito insieme (EN 20).

Il tubo vuoto va fissato almeno ogni 500 mm e il raggio curvato deve essere maggiore di 100 mm.

Attenzione: Nei tubi vuoti per il cavo del blocco di elettrovalvole e per il cavo luce non devono essere posati dei cavi elettrici che conducono una tensione maggiore di 12 V.

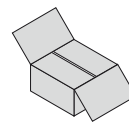

Ricevitore:

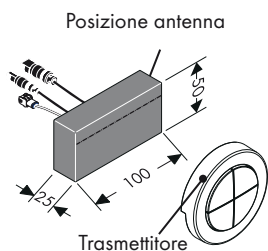

Il ricevitore deve essere installato preferibilmente nello stesso locale del dispositivo doccia.

Se ciò non è possibile, allora il ricevitore può essere installato anche in un locale vicino al dispositivo doccia.

Il ricevitore non deve essere installato in una scatola metallica, altrimenti i segnali radio del trasmettitore vengono schermati. Inoltre bisogna fare attenzione, che vicino al luogo di installazione del ricevitore non vi siano parti metalliche schermanti.

Per un rilevamento ottimale dei segnali radio,

l'antenna del ricevitore deve essere rivolta il più possibile verso il trasmettitore.

Trasmettitore:



Alla fornitura, il trasmettitore è già programmato per il ricevitore. Il trasmettitore può essere assegnato al ricevitore attraverso i numeri di serie identici.

Trasmettitori supplementari e/o acquisiti più tardi devono essere dapprima programmati per il ricevitore. Possono essere programmati e/o memorizzati al massimo quattro trasmettitori. (vedi pagg. 40/41 Modo login).

La frequenza radio del trasmettitore è di 868,3 MHz.

Indicazione: Il ricevitore e il trasmettitore hanno un raggio di azione di circa 10,00 m. Il raggio di azione è dipendente dal fatto di quanto i segnali radio tra trasmettitore e ricevitore vengono attenuati.

Indicazione: Per motivi di sicurezza utilizzare il trasmettitore solo nel campo visivo del sistema doccia. Altrimenti potrebbe venire aperta involontariamente l'acqua.

Indicazione: Procedimento corretto alla sostituzione di un trasmettitore difettoso con uno nuovo:

1. Cancellare tutti i trasmettitori. (Modo login ⇒ Modalità di cancellazione).
2. Riprogrammare di nuovo tutti i trasmettitori, all'infuori del trasmettitore difettoso. (Modalità di servizio ⇒ Modo login).

Materiale	Attenuazione
Legno, gesso, vetro (non rivestito, senza metallo)	0 - 10 %
Mattoni, pannelli truciolati di compensato	5 - 35 %
Calcestruzzo con armatura di ferro	10 - 90 %
Metallo, accoppiata di alluminio	90 - 100 %

Magnete:



Per l'attivazione della modalità Servizio il magnete deve azionare il contatto REED (dietro la rosetta). (vedi pagg. 38/39, Modalità di servizio).

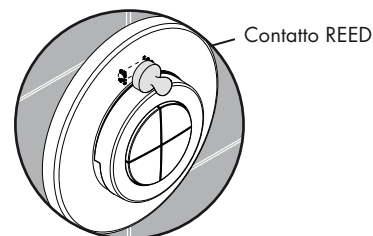

Raindance Rainfall

28411000

iControl mobile

15940180 / 15942000

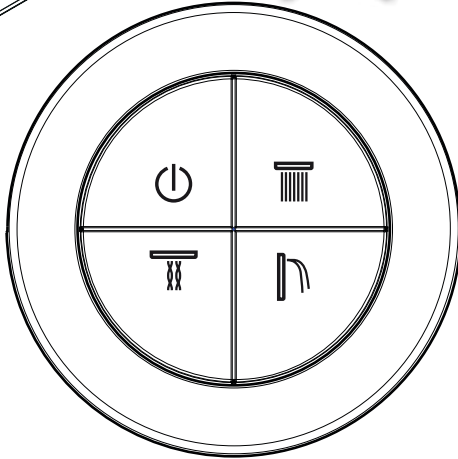
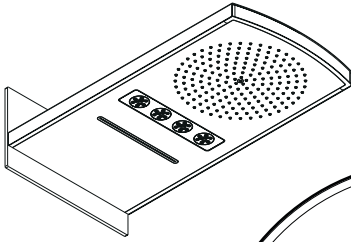

Raindance Rainfall

28411000

iControl mobile

15941180 / 15944000

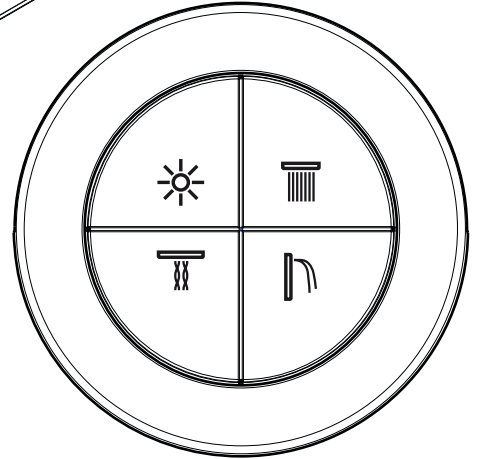
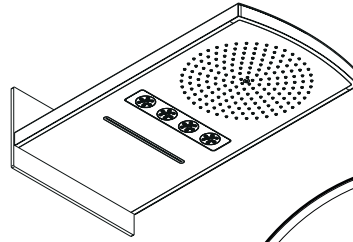

Raindance Rainmaker

28403000

iControl mobile

15940180 / 15943000

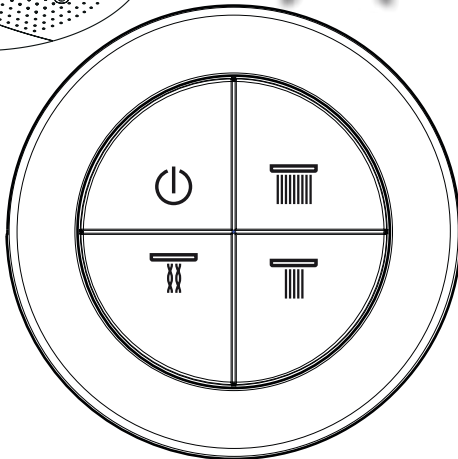
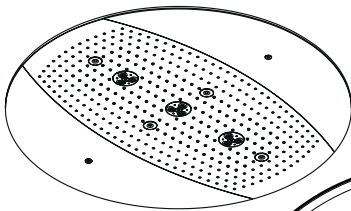

Raindance Rainmaker

28404000

iControl mobile

15941180 / 15945000

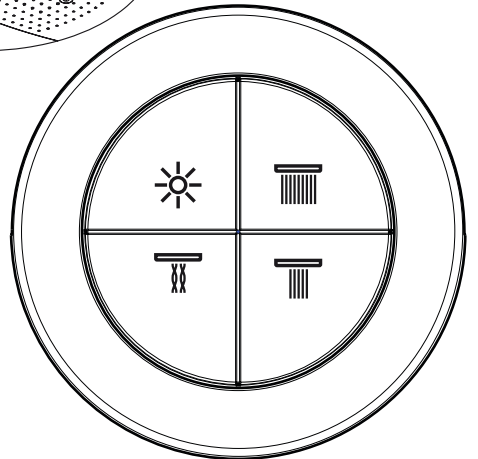
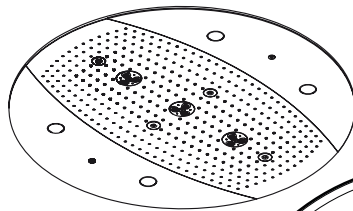

Tutto OFF



Rain



Whirl



Rainflow



Luce



Rain AIR XXL



Rain AIR

Accensione e spegnimento doccia e luce:

(Funzione standard con luce)

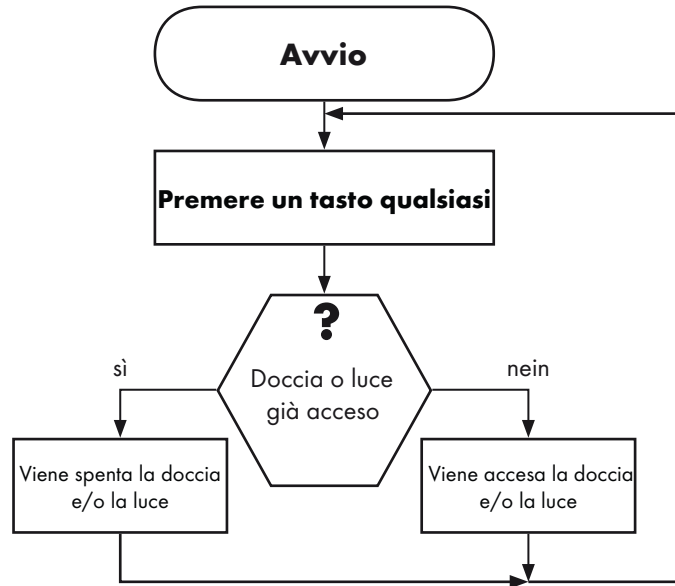

Accensione e spegnimento doccia:

(Funzione standard senza luce)

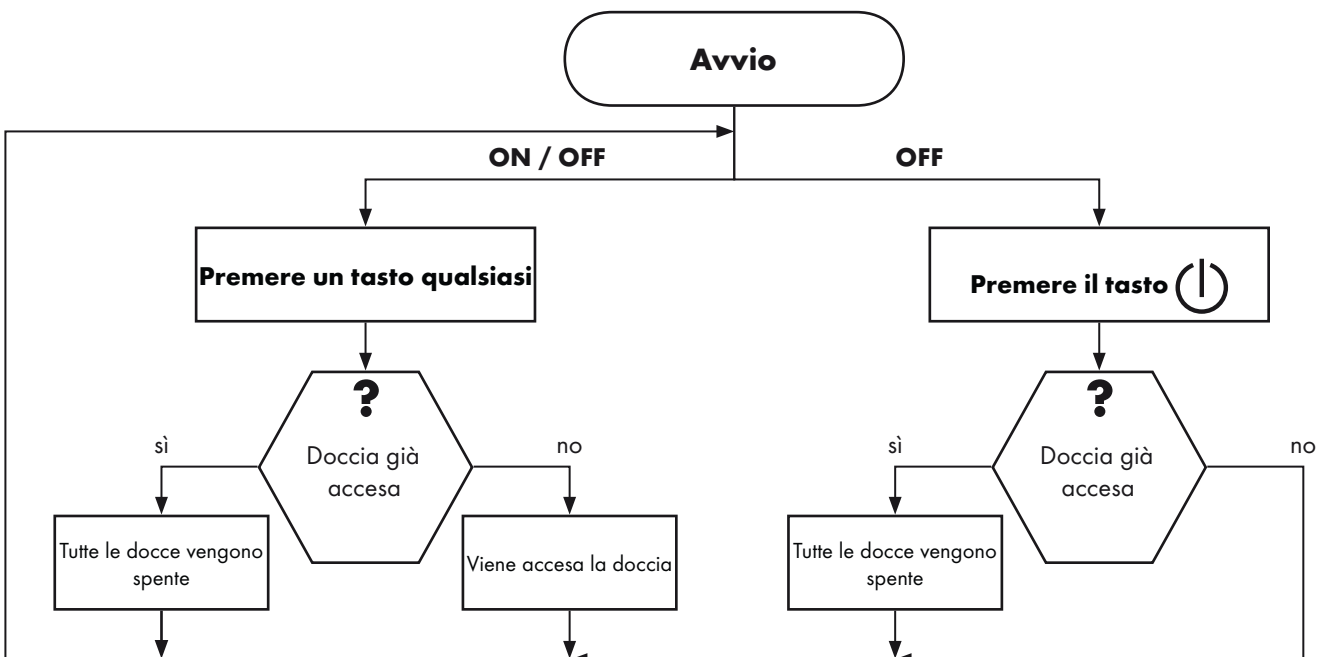

Italiano
Livello operatore

Raindance Rainfall
28411000

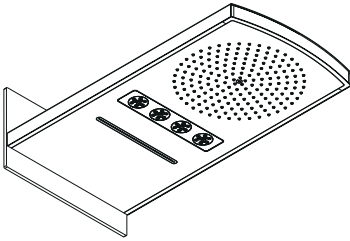

**Modalità funziona-
mento**

Indicazione:
Tutte le docce devono
essere spente



Modalità di servizio
Indicazione:
Luce / spina codificata lam-
peggia 4 volte

Indicazione:
Luce / spina codificata
lampeggia 2 volte

Indicazione:
Luce / spina codificata si
spegne

< 15 sek.

> 15 sek.

Cliccare doppio il tasto

**Cliccare doppio il
tasto**

**Modalità durata massi-
ma**
Indicazione:
Luce / spina codificata lam-
peggia a cadenza di 1 sec.

Modalità doccia
Indicazione:
Luce / spina codificata lam-
peggia a cadenza di 2 sec.

< 15 sek.

> 15 sek.

< 15 sek.

> 15 sek.

**Premere il
tasto**

**Premere il
tasto**

**Premere il
tasto**

**Premere il
tasto**

**Premere il
tasto**

**Premere il
tasto**

Durate:
Docce: 30 s
Luce: 30 min

Standard:
Durate:
Docce: 60 s
Luce: 30 min

Durate::
Docce: 180 s
Luce: 30 min

Durate:
Docce + luce:
infinito

Standard
Possono essere
accese al massi-
mo 2 docce

Comfort 1:
Possono essere
accese contem-
poraneamente
tutte le docce

Italiano
Livello operatore

Raindance Rainmaker
28403000 / 28404000

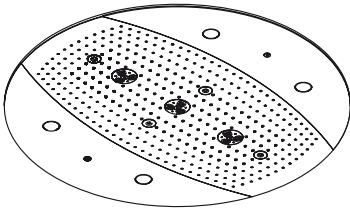

**Modalità funziona-
mento**

Indicazione:
Tutte le docce devono
essere spente



Modalità di servizio
Indicazione:
Luce / spina codificata lam-
peggia 4 volte

Indicazione:
Luce / spina codificata
lampeggia 2 volte

Indicazione:
Luce / spina codificata si
spegne

< 15 sek.

> 15 sek.

Cliccare doppio il tasto

**Cliccare doppio il
tasto**

**Modalità durata massi-
ma**
Indicazione:
Luce / spina codificata lam-
peggia a cadenza di 1 sec.

Modalità doccia
Indicazione:
Luce / spina codificata lam-
peggia a cadenza di 2 sec.

< 15 sek.

> 15 sek.

< 15 sek.

> 15 sek.

**Premere il
tasto**

**Premere il
tasto**

**Premere il
tasto**

**Premere il
tasto**

**Premere il
tasto**

**Premere il
tasto**

**Premere il
tasto**

Durate:
Docce: 30 s
Luce: 30 min

Standard:
Durate:
Docce: 60 s
Luce: 30 min

Durate::
Docce: 180 s
Luce: 30 min

Durate:
Docce + luce:
infinito

Standard
Possono essere
accese al massi-
mo 2 docce

Comfort 1:
Possono essere
accese contem-
poraneamente
tutte le docce

Comfort 2:
Quantità acqua
maggiore,
necessario solo
alla pulizia

Italiano
Livello esperto

Raindance Rainfall
28411000

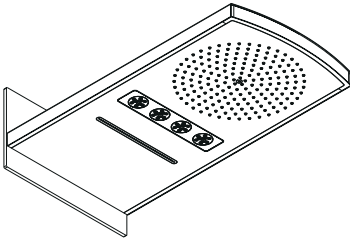

**Modalità funziona-
mento**

Indicazione:
Tutte le docce devono
essere spente



Modalità di servizio

Indicazione:
Luce / spina codificata lam-
peggia 4 volte

Indicazione:
Luce / spina codificata si
spegne

Indicazione:
Luce / spina codificata
lampeggia 2 volte

< 15 sek.

> 15 sek.

**Premere 1 volta un tasto
qualsiasi**

**Cliccare doppio il
tasto**

**Cliccare doppio il
tasto**

Modo login

**Modalità di cancellazio-
ne**

Modalità presentazione

?
È conosciuto
il trasmettito-
re

sì

no

?

Numero dei
trasmettitori
conosciuti ≤ 3
pezzi

sì

no

< 15 sek.

> 15 sek.

< 15 sek.

> 15 sek.

Indicazione:
Luce / spina codi-
ficata lampeg-
gia 1 volta

Indicazione:
Viene cancellato
il trasmettitore
conosciuto più a
lungo

Indicazione:
Luce / spina codificata
lampeggia 3 volte

Viene programmato e/o memo-
rizzato il nuovo trasmettitore

**Premere il
tasto**

**Premere il
tasto**

Vengono
cancellati tutti i
trasmettitori

Viene
cancellato il
trasmettitore
utilizzato

**Premere il
tasto**

**Premere il
tasto**

**Premere il
tasto**

Viene avviato
Presentazio-
ne 1

Viene avviato
Presentazio-
ne 2

Viene avviato
Presentazio-
ne 3

Premere un tasto qualsiasi

Indicazione:
Tutte le docce si spengono

Italiano
Livello esperto

Raindance Rainmaker
28403000 / 28404000

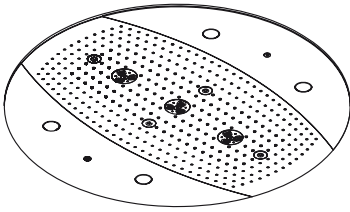

**Modalità funziona-
mento**

Indicazione:
Tutte le docce devono
essere spente



Modalità di servizio

Indicazione:
Luce / spina codificata lam-
peggia 4 volte

Indicazione:
Luce / spina codificata si
spegne

Indicazione:
Luce / spina codificata
lampeggia 2 volte

< 15 sek.

> 15 sek.

**Premere 1 volta un tasto
qualsiasi**

**Cliccare doppio il
tasto**

**Cliccare doppio il
tasto**

Modo login

**Modalità di cancellazio-
ne**

Modalità presentazione

?
È conosciuto
il trasmetti-
tore

si / no

Indicazione:
Luce / spina codificata lam-
peggia a cadenza di 0,5 sec.

Indicazione:
Luce / spina codificata lam-
peggia a cadenza di 4 sec.

?
Numero dei
trasmettitori
conosciuti ≤ 3
pezzi

si / no

< 15 sek.

> 15 sek.

< 15 sek.

> 15 sek.

Indicazione:
Luce / spina co-
dificata lampeg-
gia 1 volta

Indicazione:
Viene cancellato
il trasmettitore
conosciuto più a
lungo

Indicazione:
Luce / spina codificata
lampeggia 3 volte

Viene programmato e/o memo-
rizzato il nuovo trasmettitore

**Premere il
tasto**

**Premere il
tasto**

**Premere il
tasto**

**Premere il
tasto**

**Premere il
tasto**

Vengono
cancellati tutti i
trasmettitori

Viene
cancellato il
trasmettitore
utilizzato

Viene avviato
Presentazio-
ne 1

Viene avviato
Presentazio-
ne 2

Viene avviato
Presentazio-
ne 3

Premere un tasto qualsiasi

Indicazione:
Tutte le docce si spengono

Normas y disposiciones legales:

La aplicación del producto está garantizada mediante la siguiente disposición legal:

- EN 15200
- EN 60335-2-105



Indicaciones de seguridad:

- La grifería solo debe ser utilizada para fines de baño, higiene y limpieza corporal.
- Los niños no deben usar el sistema de ducha sin la supervisión de un adulto.
- Niños, así como adultos con limitaciones corporales, mentales y/o sensoriales no deben utilizar el sistema de duchas sin vigilancia. Personas que se encuentran bajo el efecto de alcohol o drogas, no deben utilizar el sistema de duchas.
- Debe evitarse el contacto del chorro del pulverizador con partes sensibles del cuerpo (por ej. ojos). Debe mantenerse una distancia suficiente entre pulverizador y cuerpo.
- Grandes diferencias de presión en servicio entre agua fría y agua caliente deben equilibrarse.



Conexión eléctrica:

- Las tareas de instalación y prueba únicamente pueden ser realizadas por personal electricista cualificado, respetando las reglamentaciones de las normas VDE 0100, parte 701, e IEC 60364-7-701.
- La conexión eléctrica se realiza por medio de un sólo tomacorriente. La alimentación de energía se realiza por medio de un transformador externo.
- En el entorno inmediato no debe haber ningún material fácilmente inflamable.
- La temperatura ambiente no debe superar los 50°C.
- La alimentación de energía se realiza por medio de una conexión AC 230V/N/PE/50Hz.
- La conexión debe establecerse a través de un dispositivo de protección de corriente residual (RCD/ FI) con un interruptor diferencial de corriente ≤ 30 mA.
- Si es necesario un equilibrio de potencial, este debe ser efectuado por el cliente.
- Para la instalación eléctrica deben respetarse las disposiciones correspondientes VDE, de cada país, y EVU en su versión vigente.
- Debe garantizarse que el producto pueda ser separado de la red. Mediante un tomacorriente de acceso libre o mediante un interruptor para todos los polos, según EN 60335-1, sección 24.3.



Montaje: (ver página 303)

- ¡Atención! El grifo tiene que ser instalado, probado y testado, según las normas en vigor. (Instalación según DIN 1717) Ver instrucciones de montaje Raindance Rainfall 28411000 Raindance Rainmaker 28403000 / 28404000 / 28417000 / 28418000
- Todos los trabajos que se realicen, deben llevarse a cabo en estado sin tensión.
- La base 15941180 únicamente se puede montar en posición vertical. Montaje con anillo de ajuste (A) solo posible en área delantera y media.
- Procure que sean accesibles todos los componentes.

Datos técnicos:

Presión en servicio::	max. 1 MPa
Presión recomendada en servicio:	0,1 - 0,5 MPa
Presión de prueba::	1,6 MPa
(1 MPa = 10 bar = 147 PSI)	
Temperatura del agua caliente::	max. 80° C
Temp. recomendada del agua caliente:	65° C
Racores excéntricos:	G 3/4
Racores excéntricos Entrada:	Agua de mezcla
Caudal con 0,3 MPa	
1 Consumidor:	35 l/min
2 Consumidor:	45 l/min



Accesorios: (ver página 44)



Dimensiones: (ver página 292)



Ejemplos de montaje Raindance Rainfall: (ver página 295)



Ejemplos de montaje Raindance Rainmaker: (ver página 299)



Manejo: (ver página 46)

- En caso de fallar la alimentación de red de 230 V, no se puede poner en funcionamiento la ducha.
- ¡El producto no ha sido diseñado para uso en conexión con un baño de vapor!



Limpiar Filtro: (ver página 309)





























Piezas de recambio (ver página 311)

Español

Informaciones técnicas

Problema	Causa	Solución
Ninguna función	<ul style="list-style-type: none"> - Ningún suministro de tensión - Transformador de kit principal defectuoso - Receptor mal ubicado/ defectuoso - Emisor no programado/ defectuoso 	<ul style="list-style-type: none"> - Asegurar suministro de tensión - Cambio de transformador - Modificar la posición de receptor o si es necesario, cambiar el receptor - Programar/ cambiar emisor
El modo de funcionamiento no puede ser configurado	<ul style="list-style-type: none"> - Contacto Reed no ubicado en la posición correcta, detrás de la roseta. - Contacto Reed defectuoso 	<ul style="list-style-type: none"> - Colocar contacto Reed en la roseta - Cambiar la válvula magnética del conducto de conexión
Ninguna función de luz	<ul style="list-style-type: none"> - Transformador Rainmaker no conectado/ error - Conductos de suministro del rele de luz erróneo/ defectuoso 	<ul style="list-style-type: none"> - Asegurar transformador de suministro de tensión/ cambiar transformador - Comprobar/ cambiar las conexiones y el relé de luz
Los dispositivos consumidores se desconectan automáticamente	<ul style="list-style-type: none"> - Duración ubicada en el modo de programa 	<ul style="list-style-type: none"> - Prolongar/ desconectar tiempo de marcha en inercia en el modo de servicio
Grifería con escape	<ul style="list-style-type: none"> - Válvula magnética sucia/ defectuosa 	<ul style="list-style-type: none"> - Limpiar/ cambiar membrana de válvula magnética
Muy poca corriente	<ul style="list-style-type: none"> - Filtro receptor de suciedad en el ingreso está sucio 	<ul style="list-style-type: none"> - limpiar/cambiar el filtro

Símbolos

	Conexión de agua DN 20 Agua caliente		Transformador		Protección equipotencial
	Conexión de agua DN 20 Agua fría		Receptor		todas las funciones apagadas
	Abrir el agua		Interruptor codificado		Iluminación
	Cerrar el agua		230V		Rain
	Mínimo • para el correcto funcionamiento.		12V		Whirl
	El caudal de desagüe debe ser como mínimo de 50 l/min		Tubo vacío		Rainflow
	Desagüe		Control de luz 27189000 (no incluido en el suministro)		Rain AIR XXL
	Raindrain		Relé de iluminación Rainmaker		Rain AIR
	Centro la plato de ducha		Transformador Rainmaker		Silicona (¡libre de ácido acético!)
	Conexión para luz 12 V (max. 80 W) preinstalada a cargo de la entidad constructora.				

Montaje ver página 303

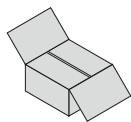

Español Accesorios

Transformador:

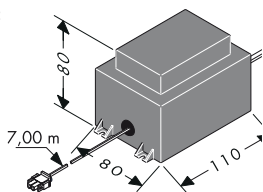

El transformador externo ofrece una potencia de 50 VA. El transformador debe instalarse en un área seca (zona de protección 3). El transformador se puede montar junto con el receptor en una carcasa de plástico, respetando la norma EN/IEC 60335-1. (dimensiones aprox. 250 x 160 x 92 mm, no forma parte del suministro.) El cable suministrado permite montar el transformador a una distancia de 7 m, como máximo, del receptor. Para ello, es imprescindible prever un tubo vacío EN35 (no forma parte del suministro). El tubo vacío se debe fijar cada 500 mm, formando un radio de flexión superior a 100 mm.

No se puede acortar el cable secundario del transformador (longitud aproximada: 7m). Si es

necesario, enrolle el cable cerca del transformador de seguridad. No se pueden reemplazar los cables de conexión dañados. En tal caso, queda prohibido poner en marcha el transformador.

No se pueden reemplazar los cables de conexión dañados. En caso de que haya un conducto de conexión de la red defectuoso, el conducto, incluyendo el transformador, debe ser cambiado por un electricista.

Relé de iluminación:

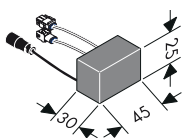

(solo para variaciones con luz integrada)

No aplicar una potencia superior a 12 V AC / 80 W en el relé de iluminación.

No es admisible la alimentación con 230 V.

Control de luz:

27189000

(no incluido en el suministro)

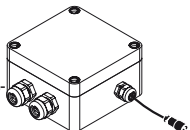

(iControl mobile 15944000)

El control de la luz debe estar conectado a una fuente de luz externa, para las diferentes variantes.

El control de la luz debe ser accesible en todo momento.

Interruptor codificado:

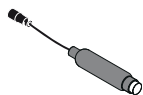

(Raindance Rainfall 28411000 / Raindance Rainmaker 28403000)

El interruptor codificado se utiliza en las versiones sin iluminación.

Activado el modo de servicio en las versiones sin iluminación, el LED del interruptor codificado indica las señales de respuesta ópticas.

El conector codificador debe estar accesible en todo momento.

Cable de conexión Bloque de válvulas magnéticas / Cable de conexión Iluminación:



No se puede acortar el cable del bloque de válvulas magnéticas (longitud aproximada: 7,5m) ni el cable de iluminación (longitud aproximada: 10m). Si es necesario, enrolle los cables cerca del receptor.

Tanto el cable del bloque de válvulas magnéticas como el cable de iluminación se deben tender en el tubo vacío suministrado (EN 20).

El tubo vacío se debe fijar cada 500 mm, formando un radio de flexión superior a 100 mm.

¡Atención: No se pueden tender cables eléctricos con una tensión asignada superior a 12V en los tubos vacíos para el cable del bloque de válvulas magnéticas y el cable de iluminación.

Montaje ver página 303

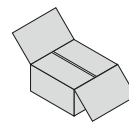

Receptor:

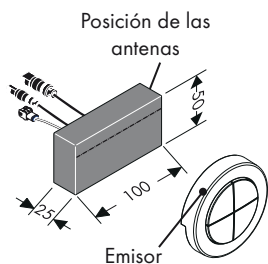

El receptor se monta preferentemente en el mismo cuarto de la ducha.

Si es necesario, se admite montar el receptor en un cuarto vecino.

Para asegurar que entran correctamente las señales del emisor, no se debe montar el receptor en una carcasa de metal que funciona como apantallamiento. Asimismo, procure reducir al mínimo necesario los componentes metálicos cerca del lugar de montaje del

Para asegurar la correcta transmisión de las

señales, oriente la antena del receptor hacia el emisor.

Emisor:



En estado de suministro, están ajustados entre sí las unidades de emisión y recepción. Las unidades de emisión y recepción ajustadas llevan un mismo número de serie.

Cualquier otro emisor adicional se debe ajustar con el receptor utilizado. Como máximo, se pueden ajustar o memorizar cuatro emisores. (ver página 50/51 Modo de aviso).

El emisor funciona con una frecuencia de 868,3 MHz.

Nota: Las unidades de emisión y recepción ofrecen un alcance de transmisión de unos 10 m. El alcance de transmisión varía según la atenuación de las señales entre las unidades de emisión y recepción.

Nota: Por motivos de seguridad usar el emisor solo en el sector visual del sistema de ducha. En caso contrario podría activarse el agua involuntariamente.

Nota: Procedimiento para cambiar un emisor defectuoso por otro nuevo:

1. Borrar todos los parámetros de los emisores existentes. (Modo de aviso ⇒ Modo borrar).
2. Ajustar todos los emisores con excepción del emisor defectuoso. (Modo reparación ⇒ Modo de aviso).

Material	Atenuación
Madera, yeso, vidrio (sin revestimiento, sin metal)	0 - 10 %
Ladrillo, tableros de madera prensada	5 - 35 %
Hormigón armado férreo	10 - 90 %
Metal, revestimiento de aluminio	90 - 100 %

Imán:



Para la activación del modo de servicio, el imán debe activar el contacto REED (detrás de la roseta) (ver página 48/49, Modo reparación).

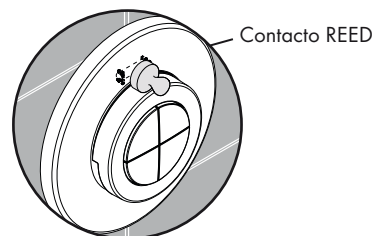

Raindance Rainfall

28411000

iControl mobile

15940180 / 15942000

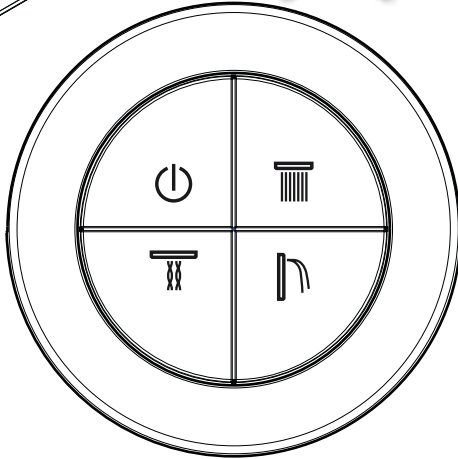
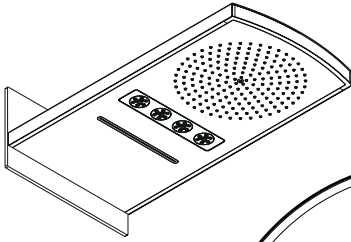

Raindance Rainfall

28411000

iControl mobile

15941180 / 15944000

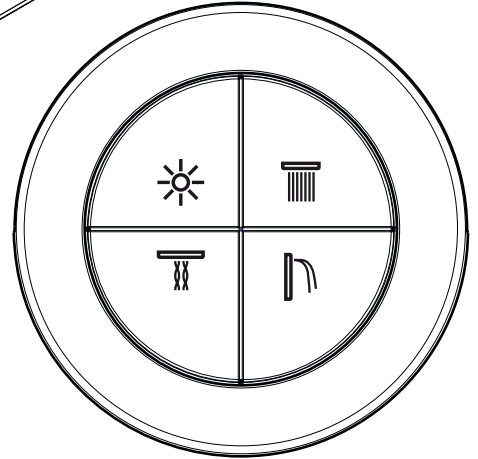
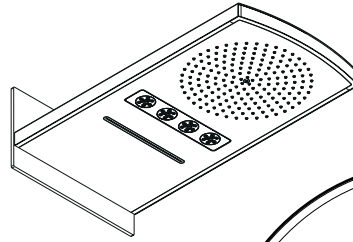

Raindance Rainmaker

28403000

iControl mobile

15940180 / 15943000

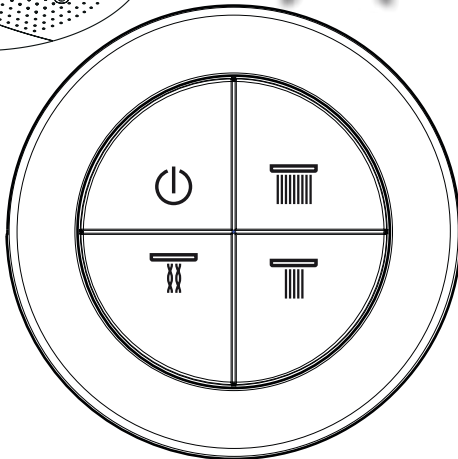
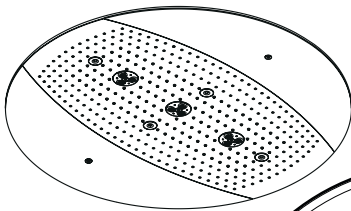

Raindance Rainmaker

28404000

iControl mobile

15941180 / 15945000

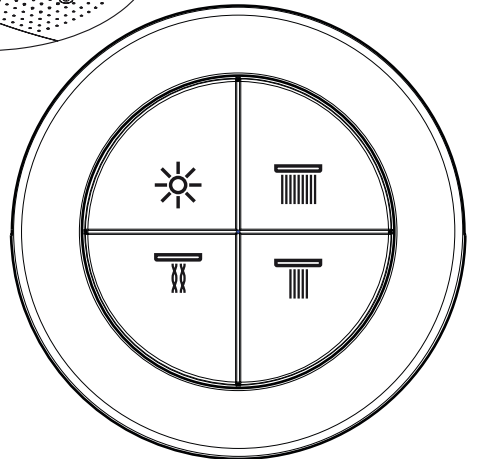
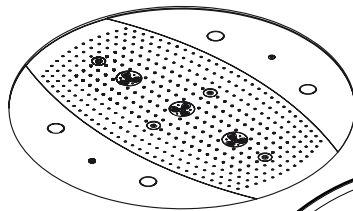

todas las funciones apagadas



Rain



Whirl



Rainflow



Iluminación



Rain AIR XXL



Rain AIR

Montaje ver página 303

Encender/apagar ducha e iluminación:

(Función estándar con iluminación)

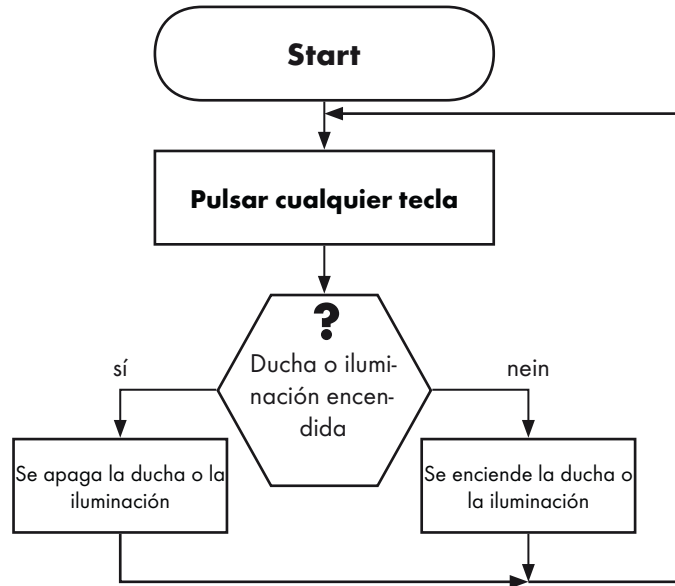

Encender/apagar la ducha:

(Función estándar sin iluminación)

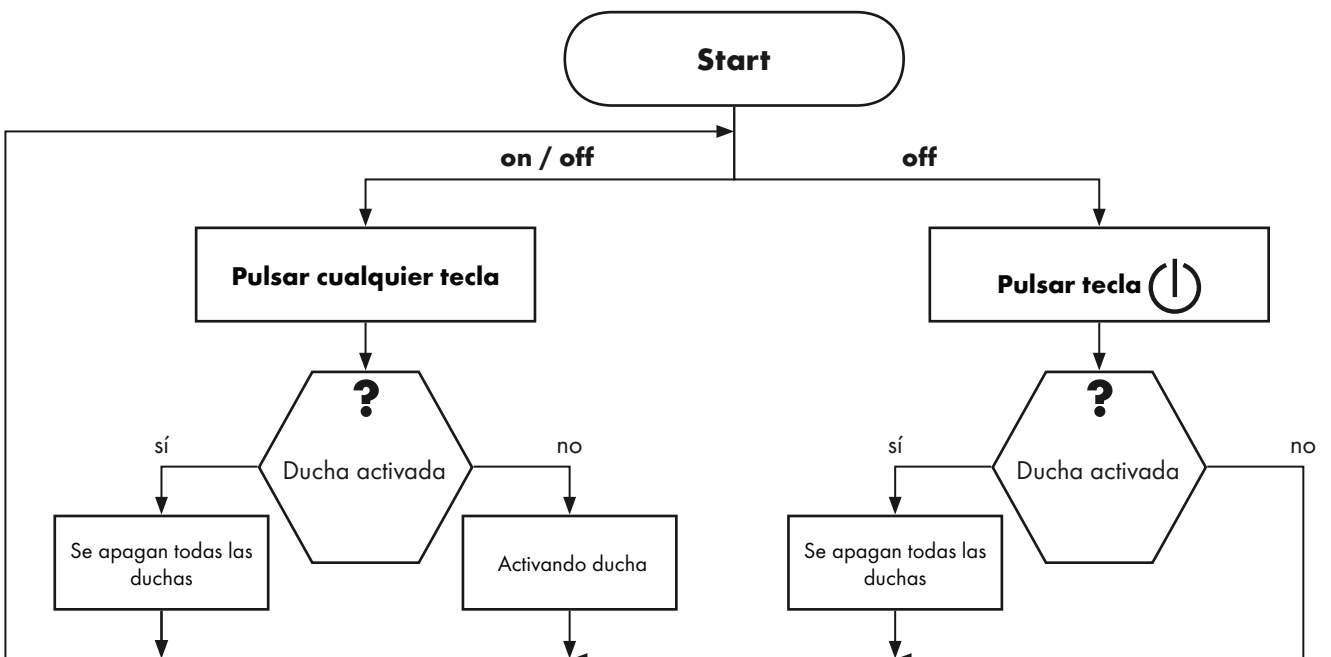

Español
Nivel de operario

Raindance Rainfall
28411000

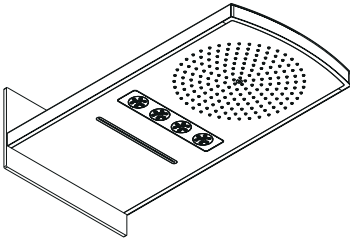

Modo de servicio

Nota:
Todas las duchas deben estar apagadas



Modo reparación



Nota:
Iluminación / interruptor codificado parpadea 4x

Nota:
Iluminación / interruptor codificado se apaga

Nota:
Iluminación / interruptor codificado parpadea 2x

< 15 sek.

> 15 sek.

Pulsar dos veces una de las teclas  o 

 Pulsar dos veces la tecla

Modo máximo tiempo de funcionamiento

Nota:
Iluminación / interruptor codificado parpadeando a intervalos de 1s

Modo duchas

Nota:
Iluminación / interruptor codificado parpadeando a intervalos de 2s

< 15 sek.

> 15 sek.

< 15 sek.

> 15 sek.

Pulsar una de las teclas  o 

 Pulsar tecla

 Pulsar tecla

 Pulsar tecla

Pulsar una de las teclas  o 

 Pulsar tecla

Tiempos de funcionamiento:
Duchas: 30 s
Iluminación: 30 min

Estándar:
Tiempos de funcionamiento:
Duchas: 60 s
Iluminación: 30 min

Tiempos de funcionamiento:
Duchas: 180 s
Iluminación: 30 min

Tiempos de funcionamiento:
Duchas + iluminación: infinitamente

Estándar
Se pueden activar, como máximo, dos duchas

Confort 1:
Se pueden activar todas las duchas a la vez

Español
Nivel de operario

Raindance Rainmaker
28403000 / 28404000

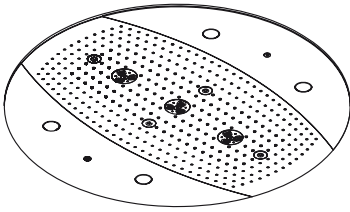

Modo de servicio

Nota:
Todas las duchas deben estar apagadas



Modo reparación



Nota:
Iluminación / interruptor codificado parpadea 4x

Nota:
Iluminación / interruptor codificado se apaga

Nota:
Iluminación / interruptor codificado parpadea 2x

< 15 sek.

> 15 sek.

Pulsar dos veces una de las teclas  o 

Pulsar dos veces la tecla 

Modo máximo tiempo de funcionamiento

Nota:
Iluminación / interruptor codificado parpadeando a intervalos de 1s

Modo duchas

Nota:
Iluminación / interruptor codificado parpadeando a intervalos de 2s

< 15 sek.

> 15 sek.

< 15 sek.

> 15 sek.

Pulsar una de las teclas  o 

Pulsar tecla 

Pulsar tecla 

Pulsar tecla 

Pulsar una de las teclas  o 

Pulsar tecla 

Pulsar tecla 

Tiempos de funcionamiento:
Duchas: 30 s
Iluminación: 30 min

Estándar:
Tiempos de funcionamiento:
Duchas: 60 s
Iluminación: 30 min

Tiempos de funcionamiento:
Duchas: 180 s
Iluminación: 30 min

Tiempos de funcionamiento:
Duchas + iluminación: infinitamente

Estándar
Se pueden activar, como máximo, dos duchas

Confort 1:
Se pueden activar todas las duchas a la vez

Confort 2:
Mayor volumen de agua, sólo necesario con Rainmaker

Español
Nivel de experto

Raindance Rainfall
28411000

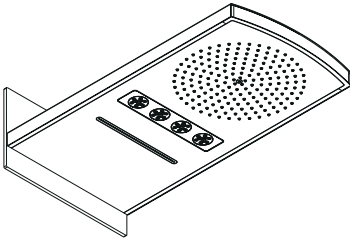

Modo de servicio

Nota:
Todas las duchas deben estar apagadas



Modo reparación

Nota:
Iluminación / interruptor codificado parpadea 4x

Nota:
Iluminación / interruptor codificado parpadea 2x

Nota:
Iluminación / interruptor codificado se apaga

< 15 sek.

> 15 sek.

Pulsar 1x una de las teclas

Modo de aviso

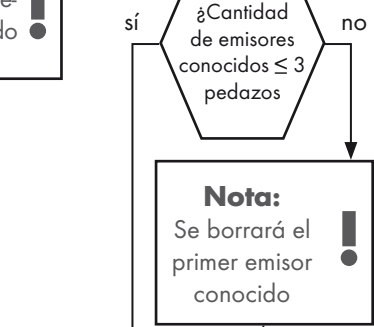

Nota:
Iluminación / interruptor codificado parpadea 3x
Se ajustará o memorizará otro emisor nuevo

Pulsar dos veces la tecla

Modo borrar

Nota:
Iluminación / interruptor codificado parpadeando a intervalos de 0,5s

< 15 sek.

> 15 sek.

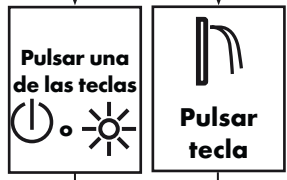

se borrarán todos los emisores
se borrará el emisor utilizado

Pulsar dos veces la tecla

Modo presentación

Nota:
Iluminación / interruptor codificado parpadeando a intervalos de 4s

< 15 sek.

> 15 sek.

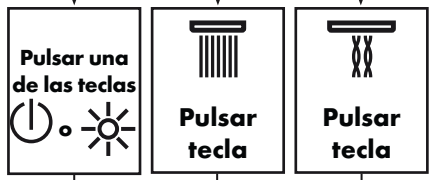

Se inicia la presentación 1
Se inicia la presentación 2
Se inicia la presentación 3

Pulsar cualquier tecla
Nota:
se apagan todas las duchas

Español
Nivel de experto

Raindance Rainmaker
28403000 / 28404000

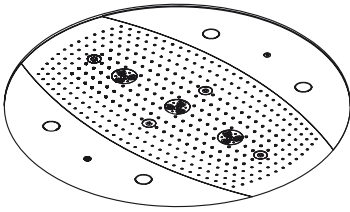

Modo de servicio

Nota:
Todas las duchas deben estar apagadas



Modo reparación

Nota:
Iluminación / interruptor codificado parpadea 4x

Nota:
Iluminación / interruptor codificado se apaga

Nota:
Iluminación / interruptor codificado parpadea 2x

< 15 sek.

> 15 sek.

Pulsar 1x una de las teclas

Modo de aviso

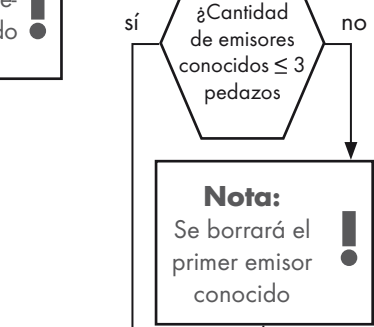

Nota:
Iluminación / interruptor codificado parpadea 3x
Se ajustará o memorizará otro emisor nuevo

Pulsar dos veces la tecla

Modo borrar

Nota:
Iluminación / interruptor codificado parpadeando a intervalos de 0,5s

< 15 sek.

> 15 sek.

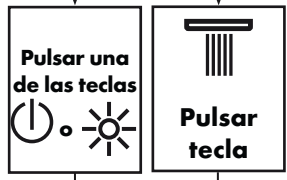

se borrarán todos los emisores
se borrará el emisor utilizado

Pulsar dos veces la tecla

Modo presentación

Nota:
Iluminación / interruptor codificado parpadeando a intervalos de 4s

< 15 sek.

> 15 sek.

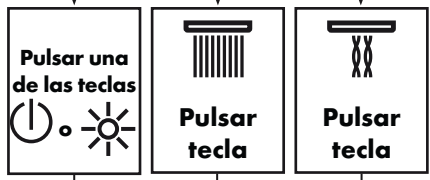

Se inicia la presentación 1
Se inicia la presentación 2
Se inicia la presentación 3

Pulsar cualquier tecla
Nota:
se apagan todas las duchas

Normen en richtlijnen:

De toepassing van het product is gegarandeerd door de volgende richtlijnen:

- EN 15200
- EN 60335-2-105



Veiligheidsinstructies:

- Het douchesysteem mag alleen voor het wassen, hygiënische doeleinden en voor de lichaamreiniging worden gebruikt.
- Kinderen mogen het douchesysteem niet zonder toezicht gebruiken.
- Kinderen en volwassenen met lichamelijke, geestelijke en/of sensorische beperkingen mogen het douchesysteem niet zonder toezicht gebruiken. Personen onder invloed van alcohol of drugs mogen het douchesysteem niet gebruiken.
- Het contact van de douchestraal met gevoelige lichaamsdelen (bijv. ogen) moet worden voorkomen. Er moet voldoende afstand tussen douche en lichaam aangehouden worden.
- Grote drukverschillen tussen de kouden warm wateraansluitingen dienen vermeden te worden.



Elektrische aansluiting:

- De installatie- en controlewerkzaamheden moeten uitgevoerd worden door een geautoriseerde electricien die rekening houdt met de normen VDE 0100 Deel 701 en IEC 60364-7-701.
- Voor de elektrische aansluiting heeft u enkel een stopcontact nodig. De stroomtoevoer gebeurt via een externe transformator.
- In de onmiddellijke nabijheid mogen zich geen licht ontvlambare materialen bevinden.
- De omgevingstemperatuur mag niet hoger zijn dan 50 °C.
- De volledige stroomtoevoer gebeurt via een 230V/N/PE/50Hz wisselstroomaansluiting.
- Deze moet middels een 2-polige FI-schakelaar met 30mA afgezekerd worden.
- Indien een equipotentiaalverbinding noodzakelijk is, moet hiervoor bouwzijds worden gezorgd.
- Bij de elektrische installatie moeten de overeenkomstige VDE-, nationale en EVU-voorschriften in de geldige versie in acht genomen worden.
- Er moet gegarandeerd zijn dat het product gescheiden kan worden van het stroomnet. Ofwel door een vrij toegankelijke stekker, ofwel door een alpolige schakelaar conform EN 60335-1 § 24.3.



Montage: (zie blz. 303)

- **Attentie!** Leidingen doorspoelen volgens Norm. De mengkraan vervolgens monteren en controleren. (Installatie naar EN 1717)
Zie montagehandleiding:
Raindance Rainfall 28411000
Raindance Rainmaker 28403000 / 28404000 / 28417000 / 28418000
- Alle werkzaamheden mogen alleen uitgevoerd worden in de spanningsvrije toestand.
- Het basislichaam 15941180 kan alleen verticaal ingebouwd worden!
Montage met ring (A) alleen mogelijk in het voorste en middele bereik!
- Alle componenten moeten toegankelijk blijven.

Technische gegevens:

Werkdruk: max.:	max. 1 MPa
Aanbevolen werkdruk:	0,1 - 0,5 MPa
Getest bij:	1,6 MPa
(1 MPa = 10 bar = 147 PSI)	
Temperatuur warm water::	max. 80 °C
Aanbevolen warm water temp.:	65 °C
Aansluitmaten:	G 3/4
Aansluitingen Ingang:	Mengwater
Vrije doorstroom bij 0,3 MPa:	
1 Verbruiker:	35 l/min
2 Verbruiker:	45 l/min



Toebehoren: (zie blz. 54)



Maten: (zie blz. 292)



Montagevoorbeelden Raindance Rainfall: (zie blz. 295)



Montagevoorbeelden Raindance Rainmaker: (zie blz. 299)



Bediening: (zie blz. 56)

- Bij een uitval van de 230 V netspanning kan de douche-inrichting niet gebruikt worden.
- Het product is niet voorzien voor gebruik in combinatie met een stoombad!



Reinigen zeefje: (zie blz. 309)





























Reserveonderdelen (zie blz. 311)

Montage zie blz. 303

Nederlands Technische Informaties

Storing	Oorzaak	Oplossing
Geen functie	<ul style="list-style-type: none"> - Geen spanningstoevoer - Transformator van de basisset defect - Ontvanger ongunstig geplaatst / defect - Zender niet geteacht / defect 	<ul style="list-style-type: none"> - Spanningsvoorziening garanderen - Transformator vervangen - Ontvangerpositie wijzigen resp. ontvanger vervangen - Zender teachen / vervangen
Bedrijfsmodus kan niet geconfigureerd worden	<ul style="list-style-type: none"> - Reed-contact niet op geschikte plaats achter de rozet - Reed-contact gestoord 	<ul style="list-style-type: none"> - Reed-contact aan de rozet plaatsen - Aansluitleiding magneetklep vervangen
Geen verlichtingsfunctie	<ul style="list-style-type: none"> - Transformator Rainmaker niet aangesloten / defect - Toevoerleidingen lichtrelais gestoord / defect 	<ul style="list-style-type: none"> - Spanningsvoorziening transformator garanderen / transformator vervangen - Verbindingen en lichtrelais controleren / vervangen
Verbruikers schakelen zelfstandig uit	<ul style="list-style-type: none"> - Looptijd in de programmamodus opgeslagen 	<ul style="list-style-type: none"> - Nalooptijd in de service-modus verlengen / uitschakelen
Armatuur ondicht	<ul style="list-style-type: none"> - Magneetklep verontreinigd / defect 	<ul style="list-style-type: none"> - Magneetklepmembraan reinigen / vervangen
Te laag debiet	<ul style="list-style-type: none"> - Vuilfilter aan de ingangszijde verontreinigd 	<ul style="list-style-type: none"> - Vuilvangzeef reinigen / uitwisselen

Symbol

	Wateraansluiting DN 20 Warm water		trafo		Potentiaalvereffening
	Wateraansluiting DN 20 Koud water		Ontvanger		Alles uit
	Hoofdkraan openen		Codeerstekker		Verlichting
	Water afsluiten		230V		Rain
	Vanaf • is het functioneren gegarandeerd.		12V		Whirl
	De afvoercapaciteit moet meer dan 50 l/min bedragen.		Lege buis		Rainflow
	Afvoer		Lichtregeling 27189000 (niet in leveringspakket!)		Rain AIR XXL
	Raindrain		Lichtrelais Rainmaker		Rain AIR
	Midden Douchebak		trafo Rainmaker		Silicone (azijnzuurvrij!)
			In het gebouw vooraf geïnstalleerde 2 V-aansluiting voor verlichting (max. 80 W)		

Montage zie blz. 303

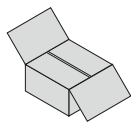

Nederlands Toebehoren

trafo:

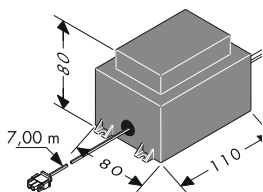

Het vermogen van de externe transformator bedraagt 50 VA. De transformator moet in het droge bereik (veiligheidszone 3) geïnstalleerd worden. De transformator kan samen met de ontvanger in een kunststofmantel ingebouwd worden, rekening houdend met EN/IEC 60335-1. (afmetingen ca. 250 x 160 x 92 mm, niet meegeleverd.) De meegeleverde kabel maakt het mogelijk om de transformator te installeren op een afstand tot 7,00 m van de ontvanger. Daarvoor moet een lege buis EN35 (niet meegeleverd) voorzien worden. De lege buis moet minstens alle 500 mm vastgezet worden en de buigradius moet groter zijn dan 100 mm. De secundaire leiding van de transformator (van ongeveer 7,00 m lang) mag niet verkort worden.

De overbodige kabellengte moet in de buurt van de veiligheidstransformator ondergebracht worden. Een beschadigde verbindingkabel mag niet vervangen worden. De transformator mag dan niet meer gebruikt worden.

Een beschadigde verbindingkabel mag niet vervangen worden. In geval van een defecte elektrische aansluitkabel moet de kabel met transformator door een elektricien vervangen worden.

Lichtrelais:

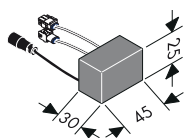

(alleen bij varianten met geïntegreerde verlichting)

Het lichtrelais mag maximaal belast worden met 12 V AC / 80 W.

De werking op het stroomnet van 230 V is niet toegelaten.

Lichtregeling:

27189000

(behoort niet tot het leveringspakket)

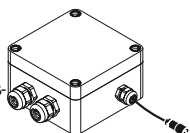

(iControl mobile 15944000)

De lichtbesturing moet aangesloten worden bij de varianten met externe lichtbron. De lichtbesturing moet te allen tijde toegankelijk zijn.

Codeerstekker:

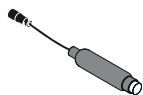

(Raindance Rainfall 28411000 / Raindance Rainmaker 28403000)

Bij de varianten zonder verlichting moet de codeerstekker aangesloten worden.

Indien bij de varianten zonder verlichting de service-modus geactiveerd is, geeft de led van de codeerstekker de optische terugmeldingen weer. De codeerstekker moet altijd toegankelijk zijn.

Verbindingsleiding Magneetventielblok / Verbindingsleiding Verlichting:



De leiding van het magneetventielblok van 7,50 m lang en de 10,00 m lange verlichtingsleiding mogen niet verkort worden. De overbodige kabellengte moet ondergebracht worden in de buurt van de ontvanger.

De leiding van het magneetventielblok en de verlichtingsleiding mogen alleen in de meegeleverde lege buis (EN 20) gelegd worden.

De lege buis moet minstens alle 500 mm vastgezet worden en de buigradius moet groter zijn dan 100 mm.

Attentie: In de lege buizen voor de leiding van het magneetventielblok en de verlichtingsleiding mogen geen elektrische leidingen gelegd worden die een spanning van meer dan 12V geleiden.

Montage zie blz. 303

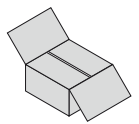

Ontvanger:

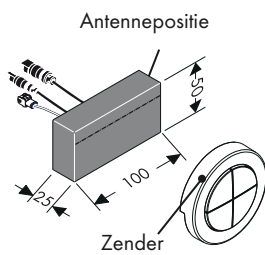

De ontvanger moet bij voorkeur in dezelfde ruimte als de douche-inrichting gemonteerd zijn.

Indien dat niet mogelijk is, kan de ontvanger ook gemonteerd worden in een ruimte die grenst aan de douche-inrichting.

De ontvanger mag niet in een metalen mantel gemonteerd worden aangezien anders de radiosignalen van de zender afgeschermd worden. Verder moet erop worden gelet dat er zich in de buurt van de inbouwplaats van de ontvanger zo weinig mogelijk afschermende, m

Voor een optimale identificatie van de radiosignalen moet de antenne van de ontvanger indien mogelijk naar de zender gericht zijn.

Zender:



Bij de levering is de zender reeds op de ontvanger geteacht. Door identieke serienummers kan de zender toegekend worden aan de ontvanger.

Extra resp. achteraf aangeschafte zenders moeten geteacht worden. Er kunnen maximum vier zenders geteacht resp. opgeslagen worden. (zie blz. 60/61 Aanmeldingsmodus).

De radiofrequentie van de zender is 868,3 MHz.

Aanwijzing: Ontvanger en zender hebben een reikwijdte van ongeveer 10,00 m. De reikwijdte hangt af van de mate waarin de radiosignalen tussen zender en ontvanger gedempt worden.

Aanwijzing: Om veiligheidsredenen de zender alleen gebruiken in het zichtbereik van het douche-systeem. Er zou bij vergissing water ingeschakeld kunnen worden.

Aanwijzing: Correcte werkwijze bij de vervanging van een defecte zender door een nieuwe:

1. Alle zenders wissen (Aanmeldingsmodus ⇒ Wis-modus).
2. Alle zenders, behalve de defecte, opnieuw teachen. (Service-modus ⇒ Aanmeldingsmodus).

Materiaal	Demping
Hout, gips, glas (niet gecoat, zonder metaal)	0 - 10 %
Baksteen, geperste spaanplaten	5 - 35 %
Beton met ijzeren wapening	10 - 90 %
Metaal, aluminiumcachering	90 - 100 %

Magneet:



Voor de activering van de servicemodus moet de magneet het REED-contact (achter de rozet) in werking stellen. (zie blz. 58/59 Service-modus).

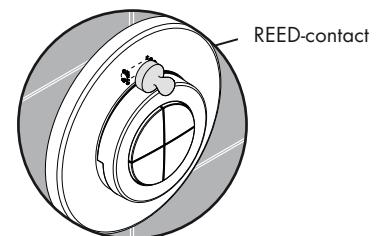

Nederlands Bediening

Raindance Rainfall

28411000

iControl mobile

15940180 / 15942000

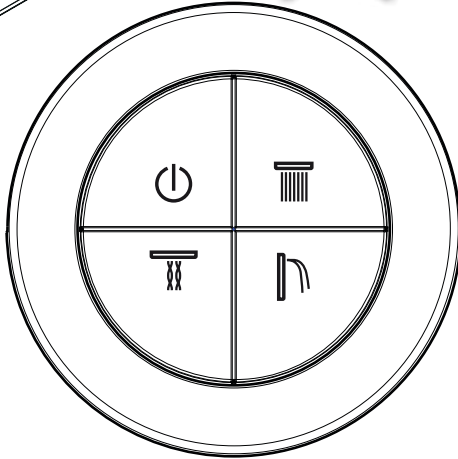
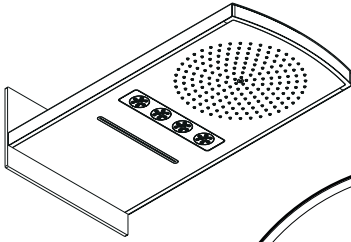

Raindance Rainfall

28411000

iControl mobile

15941180 / 15944000

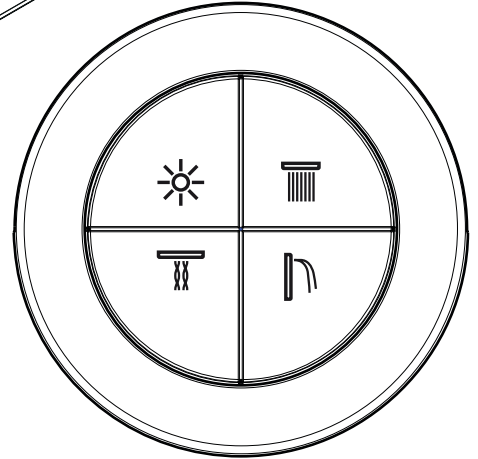
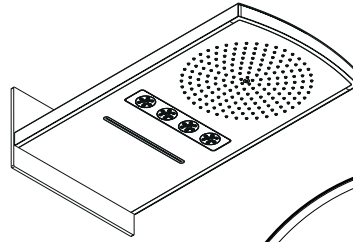

Raindance Rainmaker

28403000

iControl mobile

15940180 / 15943000

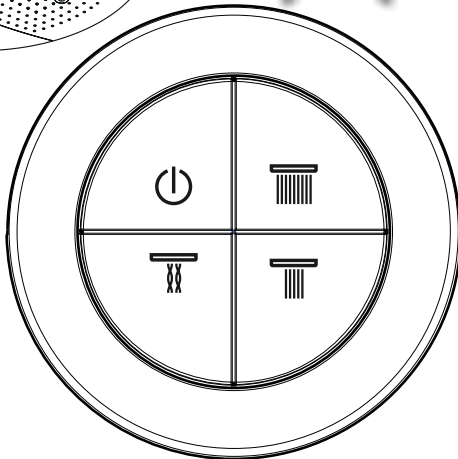
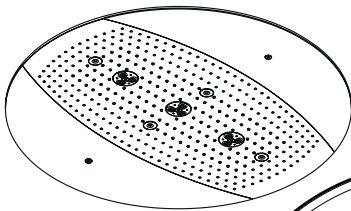

Raindance Rainmaker

28404000

iControl mobile

15941180 / 15945000

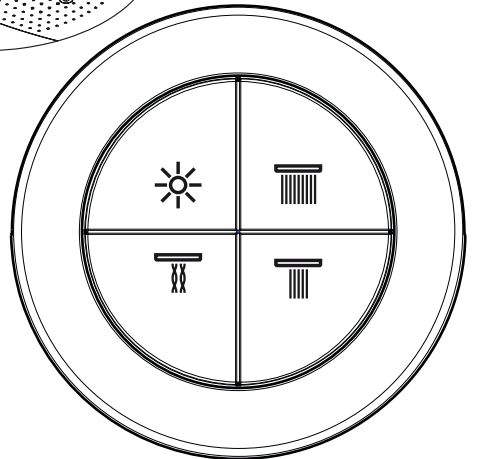
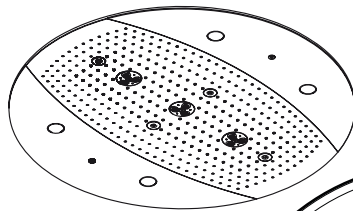

Alles uit



Rain



Whirl



Rainflow



Verlichting



Rain AIR XXL



Rain AIR

Montage zie blz. 303

Sproeiers en verlichting in- en uitschakelen:

(Standaardfunctie met verlichting)

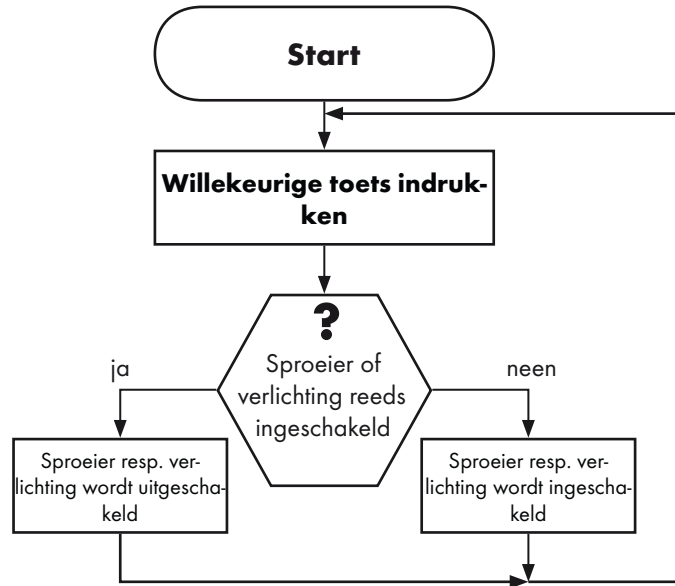

Sproeiers in- en uitschakelen:

(Standaardfunctie zonder verlichting)

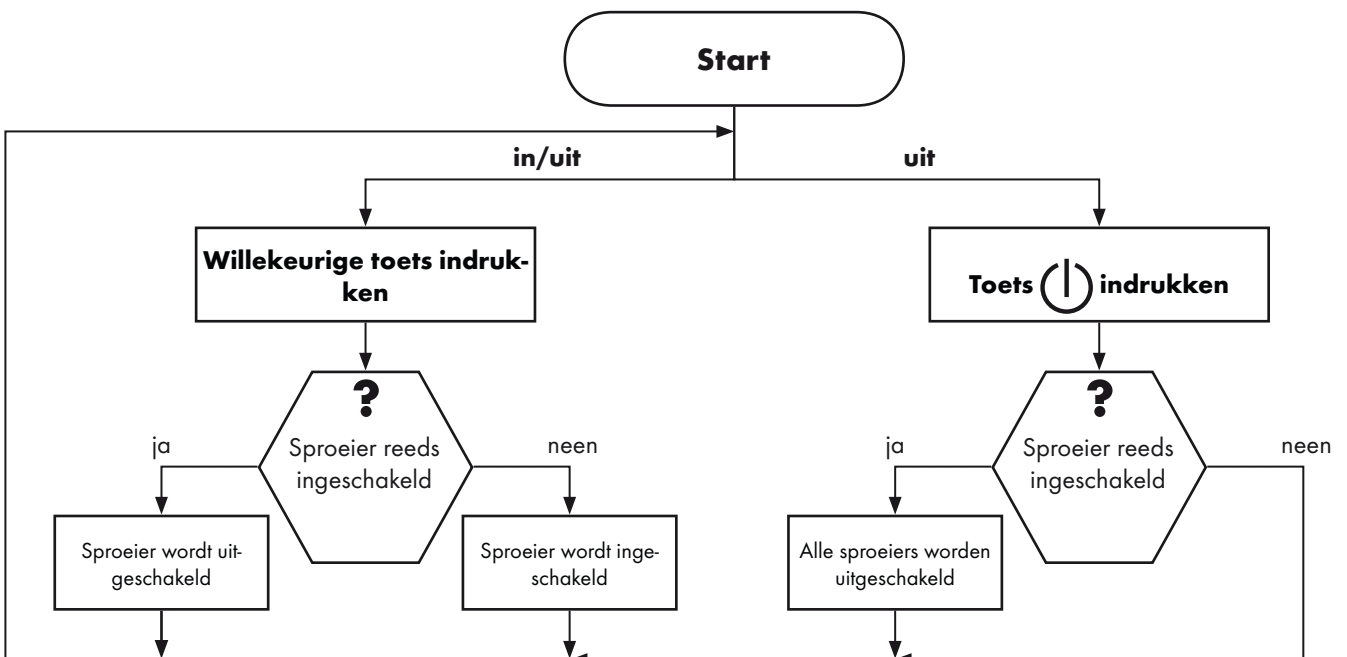

Montage zie blz. 303

Nederlands Bedieningsniveau

Raindance Rainfall
28411000

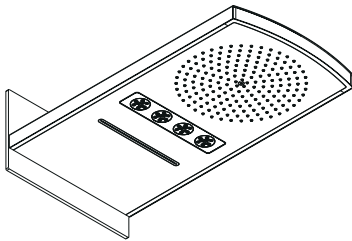

Bedrijfsmodus

Aanwijzing:
Alle sproeiers moeten uitge-
schakeld zijn

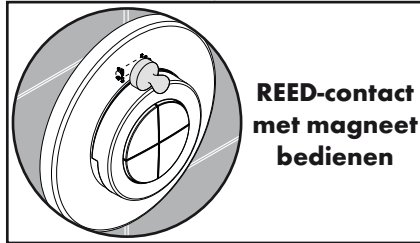

Service-modus

Aanwijzing:
Verlichting / codeerstekker
knippert 4x

Aanwijzing:
Verlichting / codeerstekker
gaat uit

Aanwijzing:
Verlichting / codeerstekker
knippert 2x

< 15 sek.

> 15 sek.

Toets  of 
dubbelklikken

Toets 
dubbelklikken

**Modus maximale loop-
tijd**

Aanwijzing:
Verlichting / codeerstekker knip-
pert met een signaal van 1 sec.

Sproeier-modus



Aanwijzing:
Verlichting / codeerstekker knip-
pert met een signaal van 2 sec.

< 15 sek.

> 15 sek.

< 15 sek.



> 15 sek.

Toets  of 
indrukken

Toets  in-
drukken

Toets  in-
drukken

Toets  in-
drukken

Toets  of 
indrukken

Toets  in-
drukken

Looptijden:
Sproeiers: 30 s
Verlichting: 30 min

Looptijden:
Standaard:
Sproeiers: 60 s
Verlichting: 30 min

Looptijden:
Sproeiers: 180 s
Verlichting: 30 min

Looptijden:
Sproeiers +
verlichting
oneindig

Standaard
Er kunnen max.
2 sproei-
ers
ingeschakeld
worden

Comfort 1:
Alle sproei-
ers kunnen
tegelijkertijd
ingeschakeld
worden

Nederlands Bedieningsniveau

Raindance Rainmaker
28403000 / 28404000

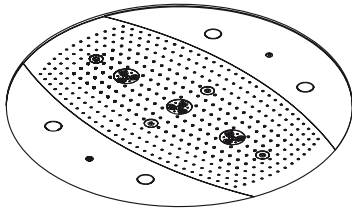

Bedrijfsmodus

Aanwijzing:
Alle sproeiers moeten uitge-
schakeld zijn

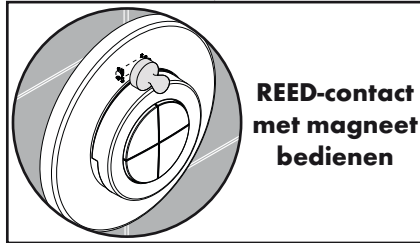

Service-modus

Aanwijzing:
Verlichting / codeerstekker
knippert 4x

Aanwijzing:
Verlichting / codeerstekker
gaat uit

Aanwijzing:
Verlichting / codeerstekker
knippert 2x

< 15 sek.

> 15 sek.

Toets  of 
dubbelklikken

Toets 
dubbelklikken

**Modus maximale loop-
tijd**

Aanwijzing:
Verlichting / codeerstekker knip-
pert met een signaal van 1 sec.

Sproeier-modus



Aanwijzing:
Verlichting / codeerstekker knip-
pert met een signaal van 2 sec.

< 15 sek.

> 15 sek.

< 15 sek.

> 15 sek.

Toets  of 
indrukken

Toets in-
drukken

Toets in-
drukken

Toets in-
drukken

Toets  of 
indrukken

Toets in-
drukken

Toets in-
drukken

Looptijden:
Sproeiers: 30 s
Verlichting: 30 min

Standaard:
Looptijden:
Sproeiers: 60 s
Verlichting: 30 min

Looptijden:
Sproeiers: 180 s
Verlichting: 30 min

Looptijden:
Sproeiers +
verlichting
oneindig

Standaard
Er kunnen max.
2 sproeiers
ingeschakeld
worden

Comfort 1:
Alle sproei-
ers kunnen
tegelijktijd
ingeschakeld
worden

Comfort 2:
Grotere
waterhoeveel-
heid, alleen bij
rainmaker nodig

Nederlands Expertenniveau

Raindance Rainfall
28411000

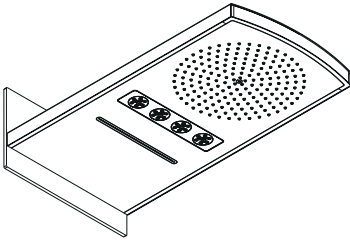

Bedrijfsmodus

Aanwijzing:
Alle sproeiers moeten uitge-
schakeld zijn



Service-modus
Aanwijzing:
Verlichting / codeerstekker
knippert 4x

Aanwijzing:
Verlichting / codeerstekker
gaat uit

Aanwijzing:
Verlichting / codeerstekker
knippert 2x

< 15 sek.

> 15 sek.

Willekeurige toets 1x
indrukken

Toets dubbelklikken

Toets dubbelklikken

Aanmeldingsmodus

Wis-modus
Aanwijzing:
Verlichting / codeerstekker knip-
pert met een signaal van 0,5 sec.

Presentatie-modus
Aanwijzing:
Verlichting / codeerstekker knip-
pert met een signaal van 4 sec.

Is de zender bekend?

ja

neen

Aanwijzing:
Verlichting / codeerstekker
knippert 1x

Aantal be-
kende zenders
≤ 3 stk.

ja

neen

Aanwijzing:
Oudste bekende
zender wordt
gewist

Aanwijzing:
Verlichting / codeer-
stekker knippert 3x
Nieuwe zender wordt geteacht
resp. opgeslagen

< 15 sek.

> 15 sek.

< 15 sek.

> 15 sek.

Toets of
indrukken

Toets in-
drukken

Alle zenders
worden gewist

De gebruikte
zender wordt
gewist

Toets of
indrukken

Toets in-
drukken

Toets in-
drukken

Presentatie 1
wordt gestart

Presentatie 2
wordt gestart

Presentatie 3
wordt gestart

Willekeurige toets indrukken
Aanwijzing:
Alle sproeiers tegelijkertijd uit

Nederlands Expertenniveau

Raindance Rainmaker
28403000 / 28404000

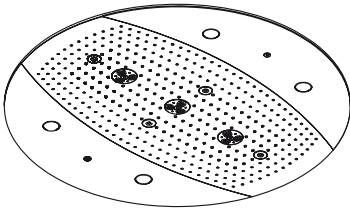

Bedrijfsmodus

Aanwijzing:
Alle sproeiers moeten uitge-
schakeld zijn



Service-modus
Aanwijzing:
Verlichting / codeerstekker
knippert 4x

Aanwijzing:
Verlichting / codeerstekker
knippert 2x

Aanwijzing:
Verlichting / codeerstekker
gaat uit

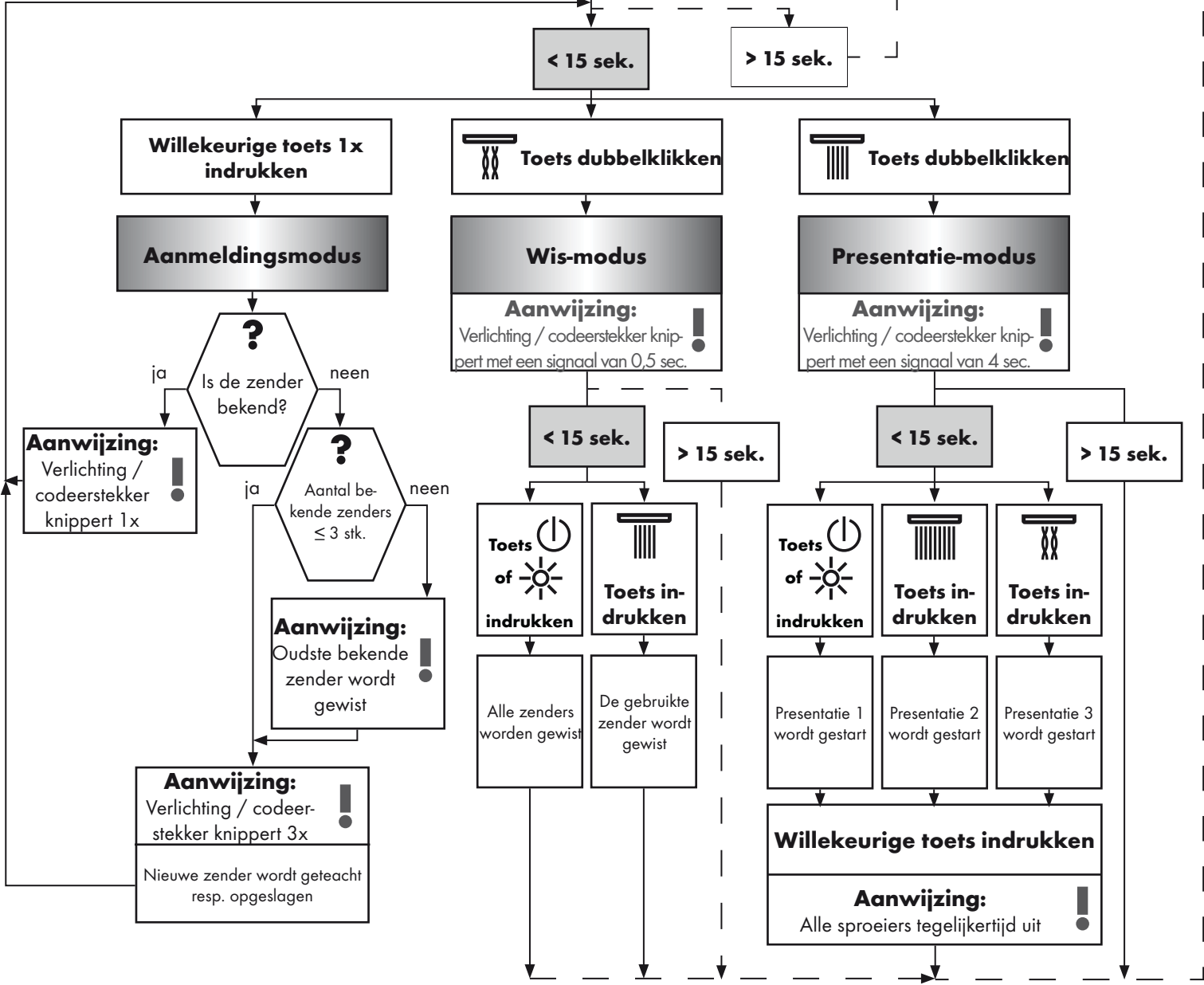

Standarder og retningslinjer:

Anvendelsen af produktet garanteres igennem følgende retningslinjer:

- EN 15200
- EN 60335-2-105



Sikkerhedsanvisninger:

- Brusersystemet må kun bruges til bade-, hygiejne og rengøringsformål.
- Børn må ikke bruge brusersystemet uden opsyn.
- Børn som også voksne med fysiske, mentale og / eller sensoriske begrænsninger må ikke bruge brusersystemet uden opsyn. Personer som er under indflydelse af alkohol eller narkotika må ikke bruge brusersystemet.
- Bruserstrålens kontakt med sensitive områder (f.eks. øjne) skal undgås. Der skal være en tilstrækkelig afstand mellem bruseren og kroppen.
- Større trykforskelle mellem koldt og varmt vand bør udjævnes.



El-tilslutning:

- Installeringen og afprøvningen skal gennemføres af en godkendt el-installatør iht. VDE 0100 part 701 og IEC 60364-7-701.
- Til indkoblingen af er kun en stikdåse nødvendigt. Strømforsyningen sker via en ekstern transformator.
- Der må ikke være let antændelige materialer i nærheden.
- Omgivelsestemperaturen må ikke være højere end 50 °C.
- Den samlede strømforsyning sker via en 230V/N/PE/50Hz vekselstrømtilslutning.
- Sikringen skal køre over en fejlstrømssikring (HFI) med en fejlstrømsdifference ≤ 30 mA.
- Hvis en potentialudligning er nødvendigt, skal den oprettes på stedet.
- Ved el-installeringen skal der tages hensyn til branchens forskrifter og de tilsvarende gældende nationale love og forskrifter.
- Det skal være sikkert, at produktet kan kobles fra strømforsyningen. Enten via et tilgængeligt stik eller en flerpolet kontakt iht. EN 60335-1 stk. 24.3



Montering: (se s. 303)

- Advarsel! Ifølge gældende regler, skal armaturet monteres, skylles igennem og afprøves. (Installation efter EN 1717)
Se monteringsvejledning:
Raindance Rainfall 28411000
Raindance Rainmaker 28403000 / 28404000 / 28417000 / 28418000
- Alle arbejder må kun gennemføres hvis apparatet er uden spænding.
- Basislegemet 15941180 kan kun monteres lodret!
Montering med justeringsring (A) er kun muligt i forreste og midterområdet!
- Alle komponenter skal forblive tilgængelige.

Tekniske data:

Driftstryk::	max. 1 MPa
Anbefalet driftstryk:	0,1 - 0,5 MPa
Prøvetryk::	1,6 MPa
(1 MPa = 10 bar = 147 PSI)	
Varmtvandstemperatur::	max. 80 ° C
Anbefalet varmtvandstemperatur:	65 ° C
Tilslutningsmål:	G ¾
Tilslutninger Indgang:	Blandet vand
Fri gennemstrømning ved 0,3 MPa:	
1 Forbruger:	35 l/min
2 Forbruger:	45 l/min



Tilbehør: (se s. 64)



Målene: (se s. 292)



Monteringseksempler Raindance Rainfall: (se s. 295)



Monteringseksempler Raindance Rainmaker: (se s. 299)



Brugsanvisning: (se s. 66)

- Ved et svigt af 230 V netspændingen, kan bruseren ikke tages i brug.
- Dette produkt er ikke beregnet til anvendelse i forbindelse med et dampbad!































Rengøring Snavsfilter: (se s. 309)

Reserve dele (se s. 311)

Dansk Tekniske informationer

Fejl	Årsag	Hjælp
Ingen funktion	<ul style="list-style-type: none"> - ingen spændingsforsyning - Transformatoren fra basissættet defekt - Modtager placeret ugunstigt / defekt - Sender ikke programmeret / defekt 	<ul style="list-style-type: none"> - Sørg for spændingsforsyningen - Udskift transformatoren - Ændr modtagerpositionen hhv. udskift modtageren - Programmerer / udskifte senderen
Funktionsmodus kan ikke konfigureres	<ul style="list-style-type: none"> - Reed kontakt ikke placeret på et egnet sted bagved rosetten - Reed kontakt fejlagtig 	<ul style="list-style-type: none"> - Placer Reed kontakten på rosetten - Udskift forsyningsledningen til magnetventilen
Ingen lysfunktion	<ul style="list-style-type: none"> - Transformator Rainmaker ikke sat i / fejleagtig - Toevoerleidingen lichtrelais gestoord / defect 	<ul style="list-style-type: none"> - Sørg for spændingsforsyningen til transformatoren / udskift transformatoren - Kontroller / udskift lysrelæet
Forbrugere afbrydes selvstændigt	<ul style="list-style-type: none"> - Funktionstid indstillet i programmodus 	<ul style="list-style-type: none"> - Forlæng / afbryde efterløbstiden i servicemodus
Armatut utæt	<ul style="list-style-type: none"> - Magnetventil smudset til / defekt 	<ul style="list-style-type: none"> - Rense / udskifte magnetventilmembranerne
For ringe gennemstrømning	<ul style="list-style-type: none"> - Snavsopsamlingsiv på indgangens side smudset til 	<ul style="list-style-type: none"> - Rengør / udskift smudsfangsi

Symbol

	Vandtilslutning DN 20 Varmt vand		Transformator		Potentialvereffening
	Vandtilslutning DN 20 Kold vand		Modtager		alt slukket
	Tænd for vandet		Kodestik		Lys
	Luk for vandet		230V		Rain
	Fra • er funktionen anvendelig.		12V		Whirl
	Afløbskapaciteten skal være mere end 50 l/min. > 50 l/min		Tomt rør		Rainflow
	Afløb		Lysstyring 27189000 (ikke med i leveringsomfang)		Rain AIR XXL
	Raindrain		Lysrelæ Rainmaker		Rain AIR
	Midt brusekar		Transformator Rainmaker		Silikone (eddikesyre-fri)
	På stedet allerede installeret 12 V-tilslutning til lys (max. 80 W)				

Montering se s. 303

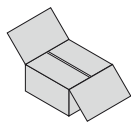

Dansk Tilbehør

Transformer:

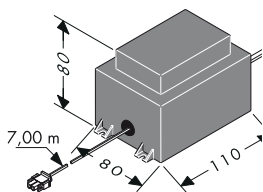

Kapaciteten af den eksterne transformer er 50 VA. Transformeren skal installeres i et tørt område (beskyttelseszone 3). Iht. EN/IEC 60335-1 kan transformeren monteres sammen med modtageren i en kunststofkasse. (dimensioner ca. 250 x 160 x 92 mm, kommer ikke med leveringen.) Det medleverede kabel muliggør en installering af transformeren op til 7,00 m fra modtageren. Hertil skal der monteres et tomt rør EN35 (kommer ikke med leveringen). Det tomme rør skal fikseres mindst hver 500 mm og rørets bøjradius må ikke være større end 100 mm.

Transformeren ca. 7,00 m lange sekundærledning må ikke afkortes. Det stykke ledning, som ikke bruges, bør opbevares i nærheden af sikkerhedstransformeren. En beskadiget tilslutningsledning må ikke erstattes. Transformeren må så ikke bruges. En beskadiget tilslutningsledning må ikke erstattes. Ved en defekt tilslutningsledning skal ledningen inklusive transformer udskiftes af en el-installatør.

Lysrelæ:

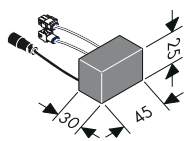

(kun ved modeller med integreret lys)
Lysrelæet må maksimalt belastes med 12 V AC / 80 W.
Brugen med et 230 V net er forbudt.

Lysstyring:

27189000

(ikke med i leveringsomfang)

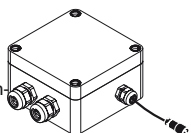

(iControl mobile 15944000)
Ved modeller med eksterne lyskilder, skal lysstyringen tilsluttes.
Lysstyringen skal altid være tilgængeligt.

Kodestik:

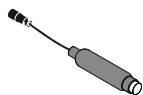

(Raindance Rainfall 28411000 / Raindance Rainmaker 28403000)
Ved modellerne uden lys, skal kodestikket tilsluttes.
Hvis service-modus blev aktiveret ved modellerne med lys, viser kodestikkets lysdiode de optiske kvitteringer.
Kodestikket skal altid være tilgængeligt.

Tilslutningsledning Magnetventilblok / Tilslutningsledning Lys:



Den 7,50 m lange magnetventilblokkledning som også den 10,00 m lange lysledning må ikke afkortes. Det stykke ledning, som ikke bruges, bør opbevares i nærheden af sikkerhedstransformeren. Magnetventilblokkledningen og lysledningen må kun nedlægges i det medleverede tomme rør (EN 20).
Det tomme rør skal fikseres mindst hver 500 mm og rørets bøjradius må ikke være større end 100 mm.

Advarsel: I de tomme rør til magnetventilblokkledningen og lysledningen må der ikke nedlægges el-ledninger som har en spænding over 12V.

Montering se s. 303

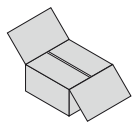

Modtager:

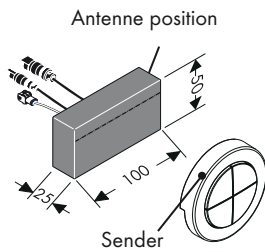

Modtageren bør fortrinsvis monteres i det samme rum som bruseren.

Hvis dette ikke er muligt, kan modtageren også monteres i et rum som grænser op til bruseren.

Modtageren må ikke integreres i et metalhus, ellers kan senderens radiosignaler afskærmes. Desuden skal der holdes øje med at der muligt få afskærmende metaldele i nærheden af modtagerens monteringssted.

Til en optimal modtagelse af radiosignalerne bør modtagerens antenne helst rettes mod senderen.

Sender:



Ved leveringen er senderen allerede justeret til modtageren. Senderen kan tilknyttes til modtageren via identiske serienumre.

Yderligere, hhv. senere sendere skal justeres til modtageren. Der kan max. justeres, hhv. gemmes fire sendere. (se s. 70/71 Anmelde-modus).

Senderens radiofrekvens er 868,3 MHz.

OBS: Modtager og sender har en rækkevidde på ca. 10,00 m. Rækkevidden er afhængig af hvor stærk radiosignalerne mellem modtageren og senderen dæmpes.

OBS: Af sikkerhedsgrunde må senderen kun bruges i brusesystemets synsområde. Ellers kan vand tændes utilsigtet.

OBS: Korrekt fremgangsmåde ved udskiftning af en defekt sender med en ny sender:

1. Slette alle sendere. (Anmelde-modus ⇒ Slette-modus).
2. Programmere alle sendere, med undtagelse af den defekte sender. (Service-modus ⇒ Anmelde-modus).

Materiale	Dæmpning
Træ, gips, glas (ikke coatet, uden metal)	0 - 10 %
Teglsten, presspanplader	5 - 35 %
Beton med armering af jern	10 - 90 %
Metal, aluminiumlaminering	90 - 100 %

Magnet:



Til aktiveren af service-modus skal magneten udløse REED-kontakten (bagved rosetten). (se s. 68/69 Service-modus).

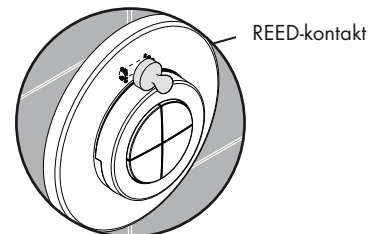

Dansk Brugsanvisning

Raindance Rainfall

28411000

iControl mobile

15940180 / 15942000

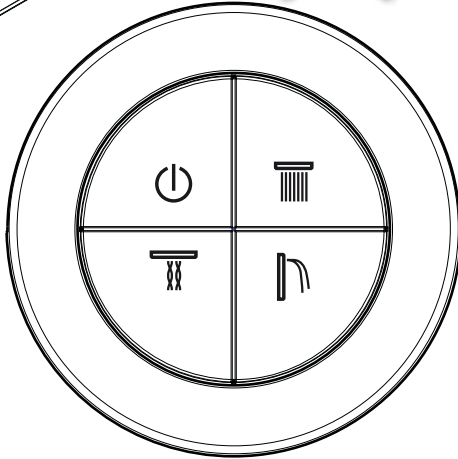
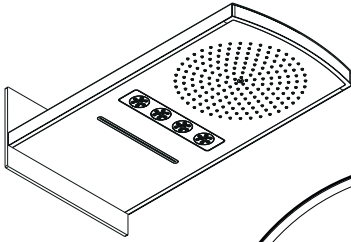

Raindance Rainfall

28411000

iControl mobile

15941180 / 15944000

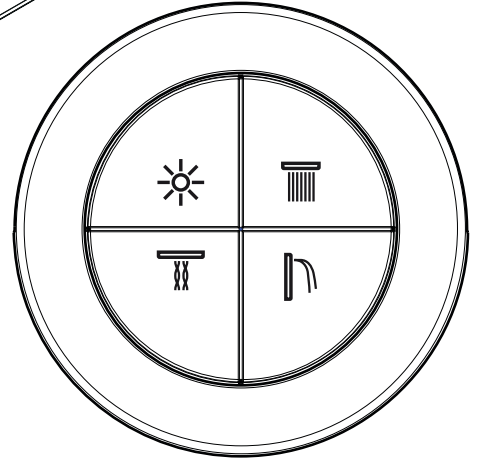
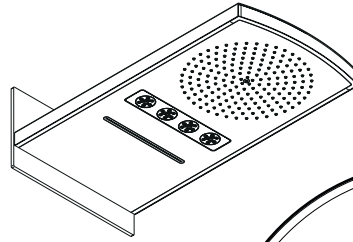

Raindance Rainmaker

28403000

iControl mobile

15940180 / 15943000

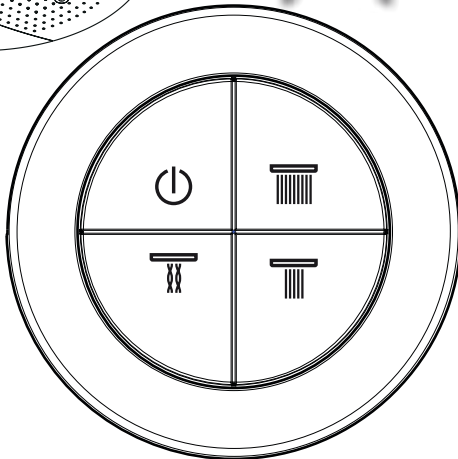
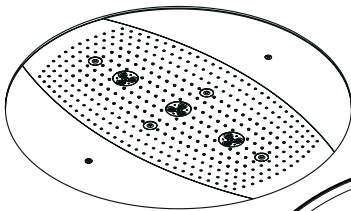

Raindance Rainmaker

28404000

iControl mobile

15941180 / 15945000

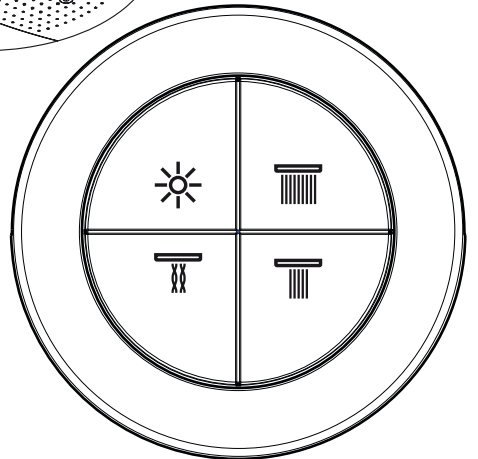
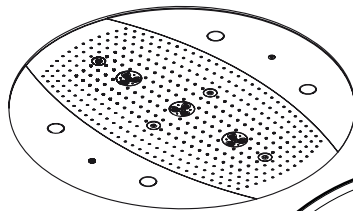

alt slukket



Rain



Whirl



Rainflow



Lys



Rain AIR XXL



Rain AIR

Montering se s. 303

Bruse og tænde/sukke lyset:

(Standardfunktion med lys)

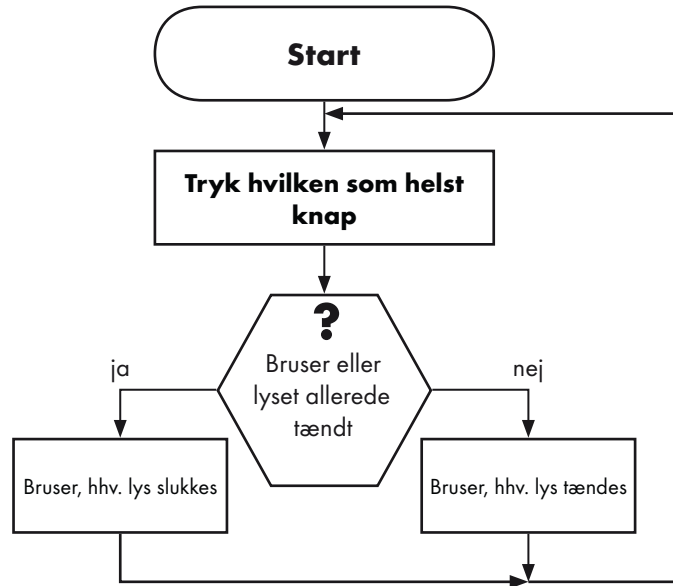

Tænde/slukke bruserne:

(Standardfunktion uden lys)

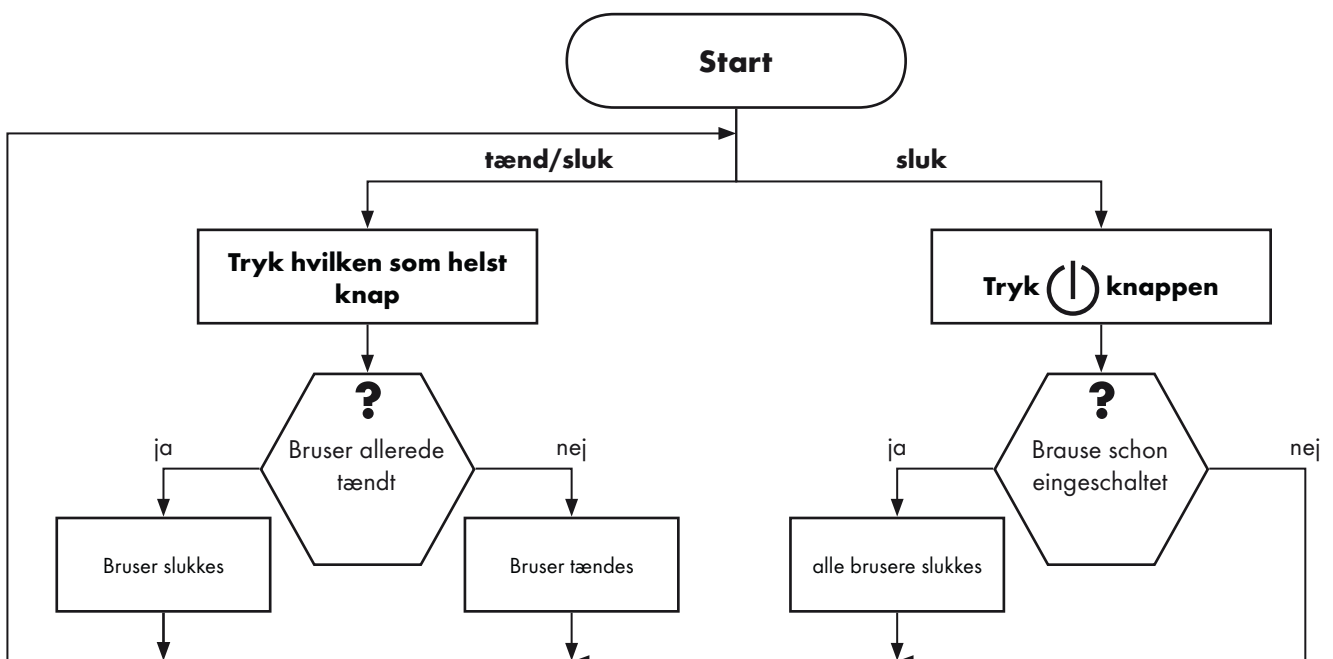

Dansk Operatør-niveau

Raindance Rainfall
28411000

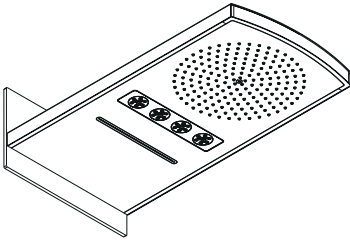

Funktionsmodus

OBS:
Alle brusere skal være slukket



Service-modus



OBS:
Lys / kodesitik blinker 4x

OBS:
Lys / kodesitik blinker 2x

OBS:
Lys / kodesitik slukkes

< 15 sek.

> 15 sek.

Knap  eller 
dobbelklik

 Dobbelklik knap

Maksimaltid-modus

OBS:
lys / kodesitik blinker i en takt på 1 sek.

Bruse-modus





OBS:
lys / kodesitik blinker i en takt på 1 sek. / 2sek



< 15 sek.

> 15 sek.

< 15 sek.

> 15 sek.

Tryk knap  eller 
eller
Tryk knappen  Tryk knappen  Tryk knappen 

Tryk knap  eller 
eller
Tryk knappen 

Løbetid:
Bruser: 30 s
Lys: 30 min

Standard:
Løbetid:
Bruser: 60 s
Lys: 30 min

Løbetid:
Bruser: 180 s
Lys: 30 min

Løbetid:
Bruser + lys:
vindeligt

Standard
max. 2 brusere
kan tændes

Komfort 1:
alle brusere kan
tændes samtidig

Dansk Operatør-niveau

Raindance Rainmaker
28403000 / 28404000

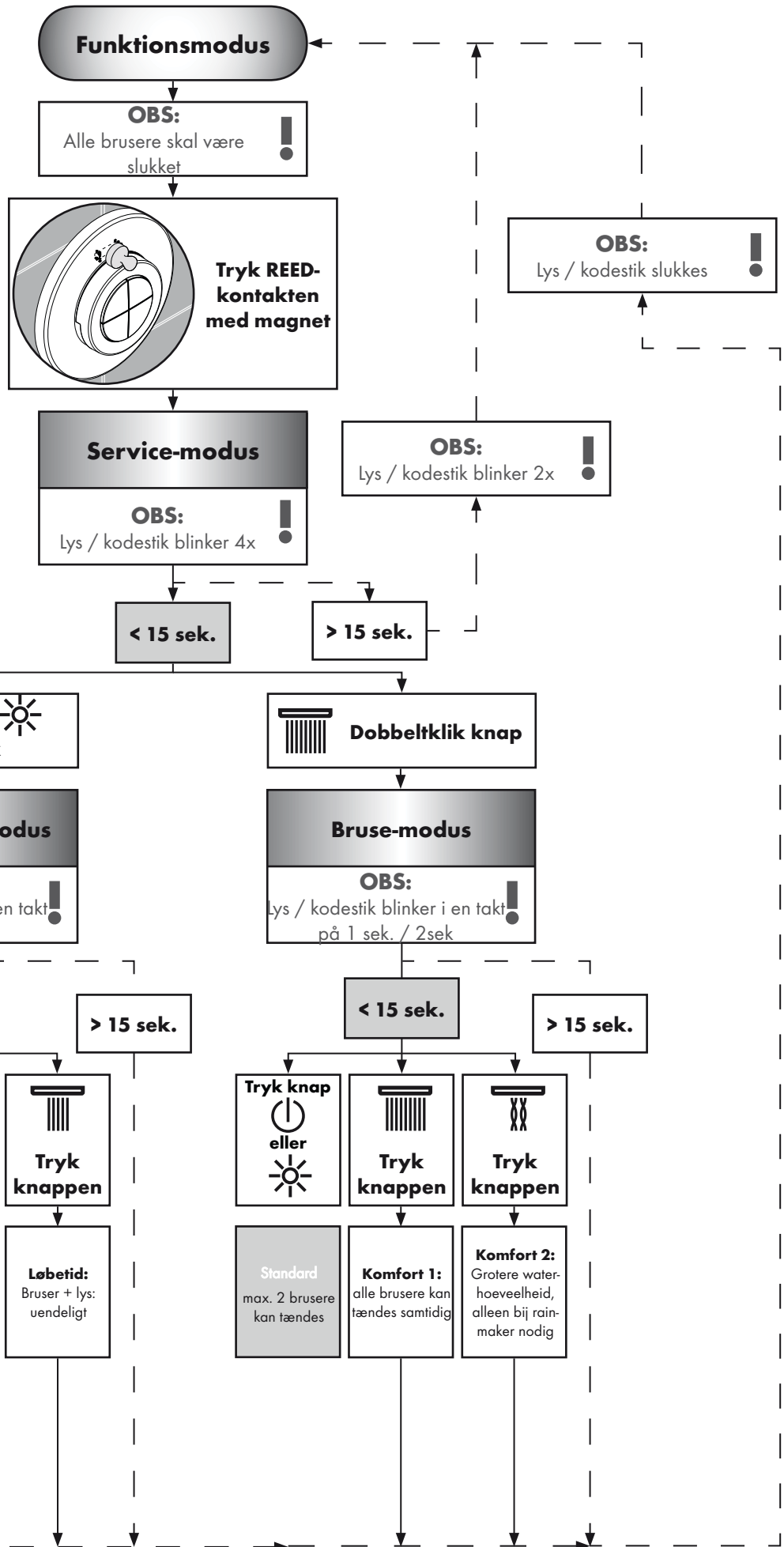
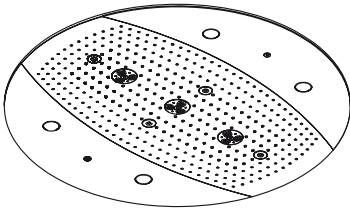

Dansk Ekspert-niveau

Raindance Rainfall
28411000

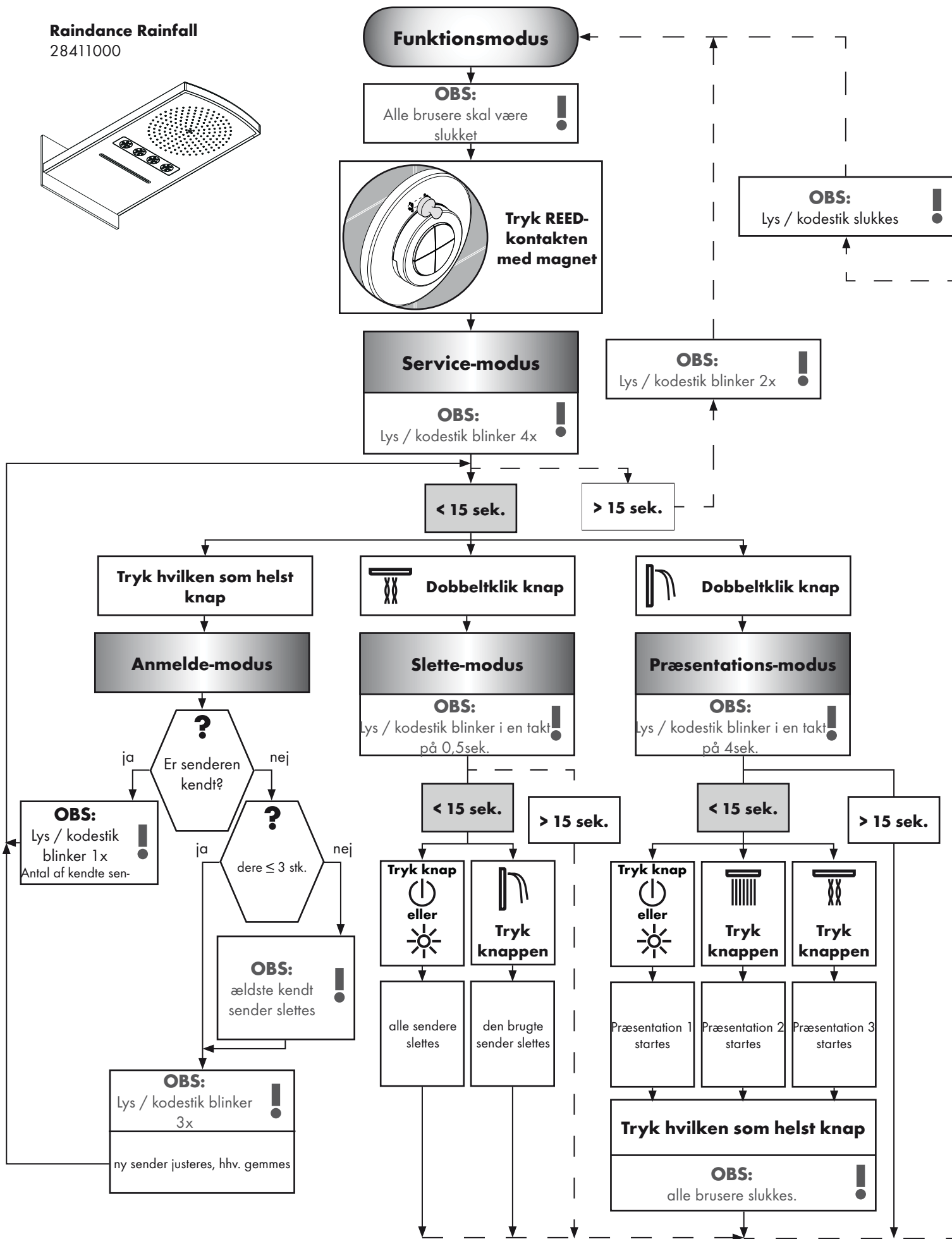
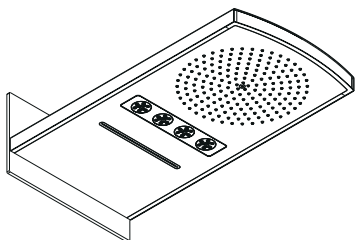

Dansk Ekspert-niveau

Raindance Rainmaker
28403000 / 28404000

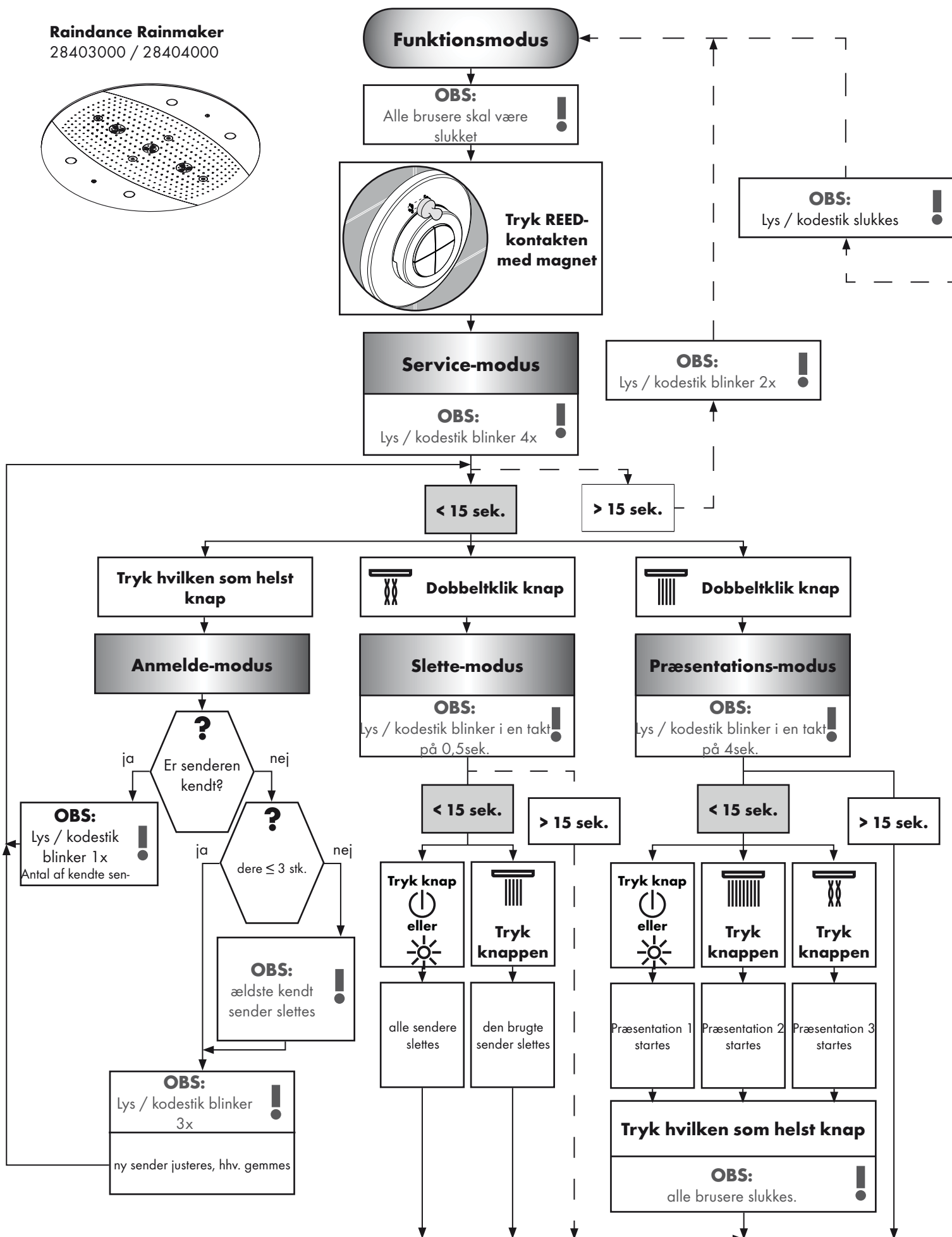
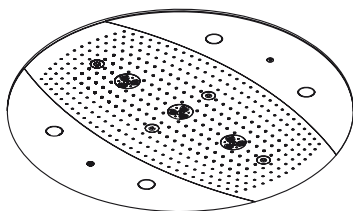

Normas e directivas:

A aplicação do produto é assegurada pelas seguintes directivas:

- EN 15200
- EN 60335-2-105



Avisos de segurança:

- O sistema de duche só pode ser utilizado para fins de higiene pessoal.
- As crianças não podem utilizar o sistema de duche sem monitorização.
- Crianças e adultos com deficiências motoras, mentais e/ou sensoriais não podem utilizar o sistema de duche sem monitorização. Pessoas que estejam sob a influência de álcool ou drogas não podem utilizar o sistema de duche.
- Deve-se evitar o contacto dos jactos de água com partes do corpo sensíveis (p. ex. olhos). É necessário manter uma distância suficiente entre o chuveiro e o corpo.
- Grandes diferenças entre as pressões das águas quente e fria devem ser compensadas.



Ligação eléctrica:

- Os trabalhos de instalação e de controlo devem ser efectuados por um técnico electricista devidamente autorizado e especializado, tendo em consideração as normas VDE 0100 Parte 701 e IEC 60364-7-701.
- Para a ligação eléctrica só é necessária uma tomada. A alimentação eléctrica é efectuada através de um transformador externo.
- Nas imediações do sistema não podem encontrar-se materiais de fácil inflamação.
- A temperatura ambiente não pode ser superior a 50 °C.
- Toda a alimentação eléctrica é efectuada através de uma ligação de corrente alternada 230V/N/PE/50Hz.
- A ligação deve estar protegida por um diferencial magneto-térmico bipolar (RRCB) com uma corrente residual ≤ 30 mA.
- Se for necessária uma ligação equipotencial, esta deve ser efectuada por parte da empresa construtora.
- Na instalação eléctrica deve ser cumprida a versão válida das prescrições VDE, nacionais e EVU.
- Deve ser assegurada a possibilidade de separação do produto da rede. Isto pode ser assegurado por uma ficha de livre acesso ou através de um interruptor onipolar, segundo EN 60335-1 par. 24.3.



Montagem: (ver página 303)

- Atenção! A misturadora deve ser instalada, purgada e testada de acordo com as normas em vigor. (Instalação segundo EN 1717)
Ver instruções de montagem:
Raindance Rainfall 28411000
Raindance Rainmaker 28403000 / 28404000 / 28417000 / 28418000
- Todos os trabalhos só podem ser realizados com o sistema desconectado da corrente eléctrica.
- O corpo base 15941180 só pode ser montado na vertical!
Montagem com anel de ajuste (A) apenas possível na área dianteira e central!
- Todos os componentes têm que permanecer acessíveis.

Dados Técnicos:

Pressão de funcionamento::	max. 1 MPa
Pressão de func. recomendada:	0,1 - 0,5 MPa
Pressão testada::	1,6 MPa
(1 MPa = 10 bar = 147 PSI)	
Temperatura da água quente::	max. 80 ° C
Temp. água quente recomendada:	65 ° C
Distância entre eixos:	G $\frac{3}{4}$
Ligações Entrada:	Água de mistura
Caudal a 0,3 MPa:	
1 Consumidor:	35 l/min
2 Consumidor:	45 l/min



Acessórios: (ver página 74)



Medidas: (ver página 292)



Exemplos de montagem Raindance Rainfall: (ver página 295)



Exemplos de montagem Raindance Rainmaker: (ver página 299)



Funcionamento: (ver página 76)

- Em caso de avaria da rede eléctrica de 230 V, não é possível colocar o duche em funcionamento.
- O produto não foi concebido para utilização em combinação com um banho de vapor!



Limpeza Filtro: (ver página 309)





























Peças sobressalentes (ver página 311)

Português

Informações técnicas

Falha	Causa	Solução
Sem função	<ul style="list-style-type: none"> - Sem alimentação eléctrica - Transformador do conjunto base com defeito - Receptor posicionado num local inadequado / com defeito - Emissor não programado / com defeito 	<ul style="list-style-type: none"> - Assegurar a alimentação eléctrica - Substituir transformador - Modificar a posição do receptor resp., substituir o receptor - Configurar / substituir emissor
Não é possível configurar o modo de operação	<ul style="list-style-type: none"> - Contacto Reed não se encontra num local adequado, atrás da roseta - Contacto Reed com defeito 	<ul style="list-style-type: none"> - Posicionar o contacto Reed na roseta - Substituir a linha de conexão da válvula magnética
Sem função de luz	<ul style="list-style-type: none"> - Transformador Rainmaker não conectado / com defeito - Linhas adutoras dos relés de luz defeituosas / com defeito 	<ul style="list-style-type: none"> - Assegurar a alimentação eléctrica do transformador / substituir transformador - Controlar / substituir ligações e relés de luz
Consumidores desligam automaticamente	<ul style="list-style-type: none"> - Tempo de funcionamento registado no modo do programa 	<ul style="list-style-type: none"> - Prolongar / desligar o tempo de funcionamento por inércia no modo de serviço
Valvularia com fuga	<ul style="list-style-type: none"> - Válvula magnética com sujidade / com defeito 	<ul style="list-style-type: none"> - Limpar / substituir a membrana da válvula magnética
Fluxo insuficiente	<ul style="list-style-type: none"> - Colector de sujidade com sujidade no lado de entrada 	<ul style="list-style-type: none"> - Limpar / trocar o filtro

Símbolos

	Ligação da água DN 20 Água quente		Transformador		Ligação equipotencial
	Ligação da água DN 20 Água fria		Receptor		tudo desligado
	Abrir a água		Ficha de codificação		Luz
	Cortar a água		230V		Rain
	• A partir deste ponto inicia-se o funcionamento correcto.		12V		Whirl
	Capacidade de escoamento tem que ser superior a 50 l/min.		Tubo vazio		Rainflow
	Escoamento		Comando de luz 27189000 (não incluído no volume de fornecimento!)		Rain AIR XXL
	Raindrain		Relé de luz Rainmaker		Rain AIR
	Meio da base de duche		Transformador Rainmaker		Silicone (sem ácido acético)
			Ligação de 12V para luz pré-instalada por parte da empresa construtora (máx. 80 W)		

Montagem ver página 303

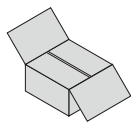

Português Acessórios

Transformador:

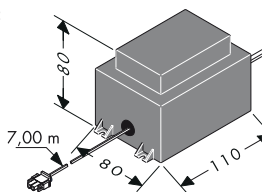

A potência do transformador externo é de 50 VA. O transformador tem que ser instalado num local seco (zona de protecção 3). O transformador pode ser montado juntamente com o receptor numa carcaça de plástico, tendo em consideração a norma EN/IEC 60335-1. (dimensões aprox. 250 x 160 x 92 mm, não incluído no volume de fornecimento.) O cabo incluído no volume de fornecimento permite a instalação do transformador a uma distância máxima de 7,00 m do receptor. Para esse efeito tem que ser instalado um tubo vazio EN35 (não incluído no volume de fornecimento). O tubo vazio tem que ser fixado em intervalos regulares de, pelo menos, 500 mm e o raio de curvatura tem que ser superior a 100 mm.

O cabo secundário de aprox. 7,00 m de comprimento do transformador não pode ser encurtado. O cabo excedente deve ser posicionado na proximidade do transformador de segurança. Não pode ser utilizado um cabo de ligação danificado. O transformador não pode ser mais utilizado. Não pode ser utilizado um cabo de ligação danificado. No caso de um cabo de ligação à rede danificado, é necessário que este e o transformador sejam substituídos por um técnico electricista.

Relé de luz:

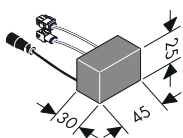

(apenas nas variantes com luz integrada)
O relé de luz pode ser sujeito a uma carga máxima de 12 V AC / 80 W.
Não é permitida a conexão à rede de 230 V.

Comando de luz:

27189000

(não incluído no volume de fornecimento)

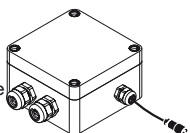

(iControl mobile 15944000)
O comando de luz tem que ser conectado nas variantes com fonte de luz externa.
O comando de luz tem que ser de livre e fácil acesso.

Ficha de codificação:

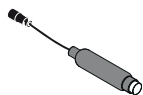

(Raindance Rainfall 28411000 / Raindance Rainmaker 28403000)
A ficha de codificação tem que ser conectada nas variantes sem luz.
Se o modo de serviço estiver activado nas variantes sem luz, o diodo luminoso da ficha de codificação indica as respostas ópticas.
A ficha de codificação tem que ser de livre acesso.

Cabo de ligação Bloco da válvula magnética / Cabo de ligação Luz:



O cabo do bloco da válvula magnética de 7,50 m de comprimento, assim como, o cabo de iluminação de 10,00 m de comprimento não podem ser encurtados. O cabo excedente deve ser posicionado na proximidade do receptor.
O cabo do bloco da válvula magnética e o cabo de iluminação só podem ser instalados no tubo vazio incluído no volume de fornecimento (EN 20).
O tubo vazio tem que ser fixado em intervalos regulares de, pelo menos, 500 mm e o raio de curvatura tem que ser superior a 100 mm.

Atenção: Nos tubos vazios para o cabo do bloco da válvula magnética e o cabo de iluminação não podem ser instalados quaisquer cabos eléctricos que sejam condutores de uma tensão superior a 12V.

Montagem ver página 303

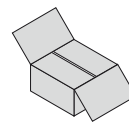

Receptor:

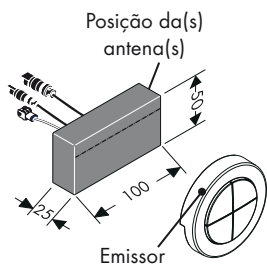

Preferencialmente, o receptor deve ser instalado no mesmo quarto que o duche.

Se tal não for possível, pode-se igualmente montar o receptor num quarto situado junto ao duche.

O receptor não pode ser montado numa caixa de metal, de modo a evitar que os sinais de rádio do emissor sejam blindados. Além disso, deve ter-se em atenção que se encontrem poucas peças metálicas, com características de blindagem, próximas do local de mon

Para uma identificação otimizada dos sinais de

rádio, a antena do receptor deve estar direccionada para o emissor.

Emissor:



No acto da entrega o emissor já está configurado no receptor. O emissor pode ser atribuído ao receptor através de números de série idênticos.

Quaisquer emissores adicionais ou adquiridos posteriormente têm que ser configurados. Podem ser configurados e memorizados no máximo quatro emissores. (ver página 80/81 Modo de registo). A frequência de rádio do emissor é 868,3 MHz.

Aviso: Procedimento correcto durante a substituição de um emissor com defeito por um emissor novo:

1. Apagar todos os emissores. (Modo de registo ⇒ Modo de eliminação).
2. Efectuar a aprendizagem (configuração) de todos os emissores, exceptuando o emissor com defeito. (Modo de manutenção ⇒ Modo de registo).

Aviso: Receptor e emissor têm um alcance de aprox. 10,00 m. O alcance depende da intensidade de amortização dos sinais de rádio, entre o emissor e receptor.

Aviso: Por motivos de segurança, o emissor só deve ser utilizado na área de visão do sistema de duche. Caso contrário, pode ser ligada inadvertidamente a água.

Material	Amortecimento
Madeira, gesso, vidro (não revestido, sem metal)	0 - 10 %
tijolo, aglomerados de madeira	5 - 35 %
betão armado	10 - 90 %
metal, revestimento em alumínio	90 - 100 %

Íman:



Para a activação do modo de serviço, o íman tem que accionar o contacto REED (atrás da roseta). (ver página 78/79, Modo de manutenção).

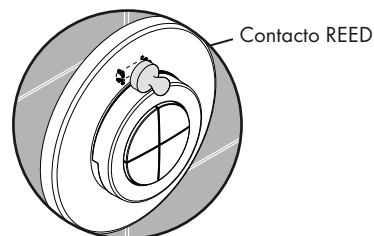

Português Funcionamento

Raindance Rainfall

28411000

iControl mobile

15940180 / 15942000

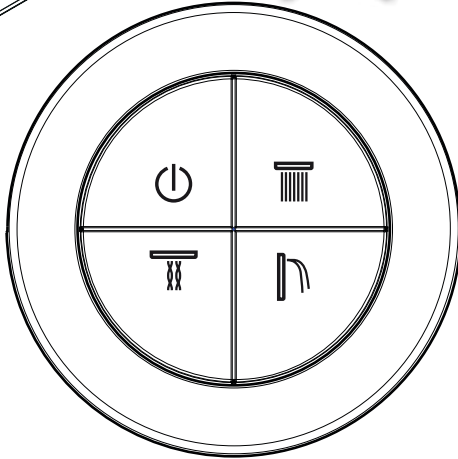
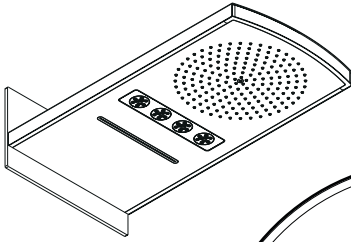

Raindance Rainfall

28411000

iControl mobile

15941180 / 15944000

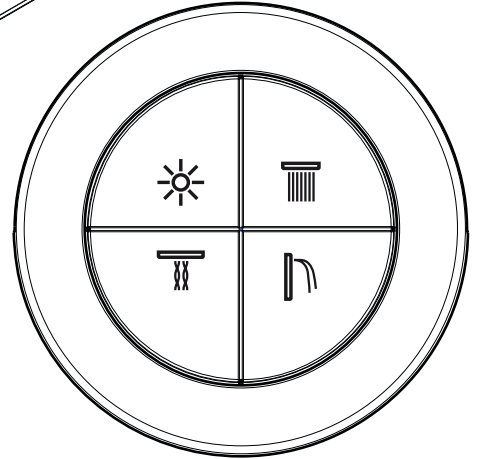
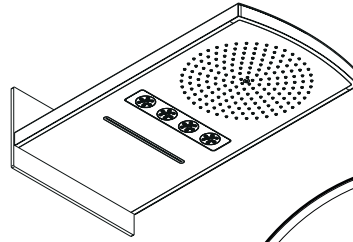

Raindance Rainmaker

28403000

iControl mobile

15940180 / 15943000

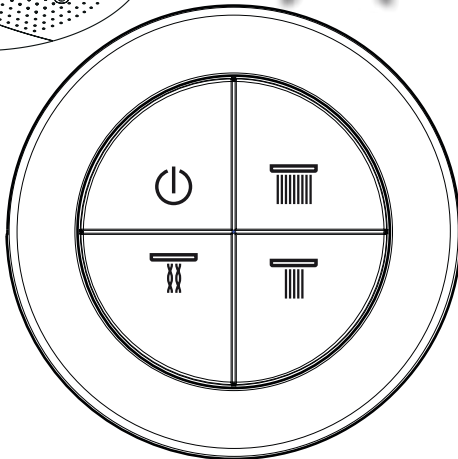
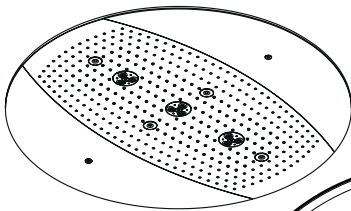

Raindance Rainmaker

28404000

iControl mobile

15941180 / 15945000

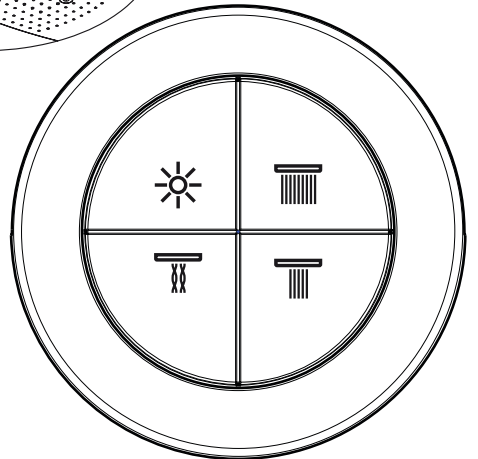
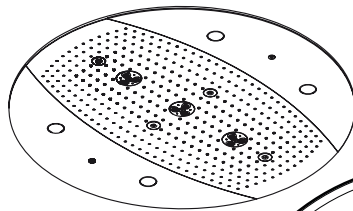

tudo desligado



Rain



Whirl



Rainflow



Luz



Rain AIR XXL



Rain AIR

Montagem ver página 303

Ligar e desligar os chuveiros e a luz:

(Função padrão com luz)

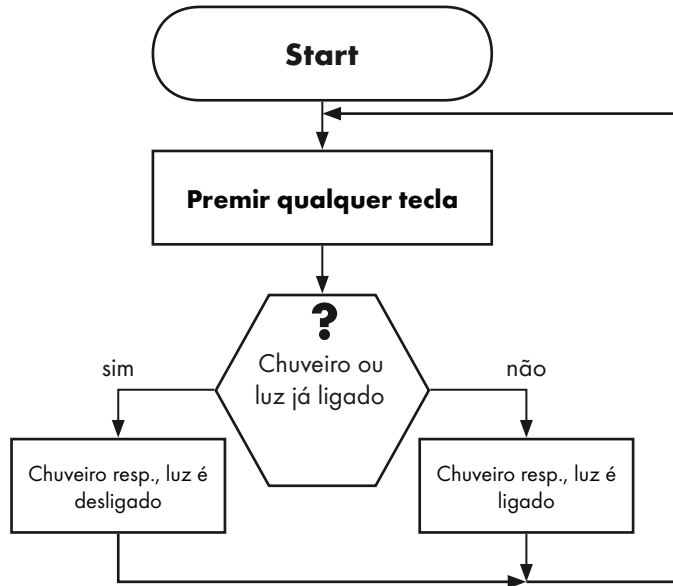

Ligar e desligar os chuveiros:

(Função padrão sem luz)

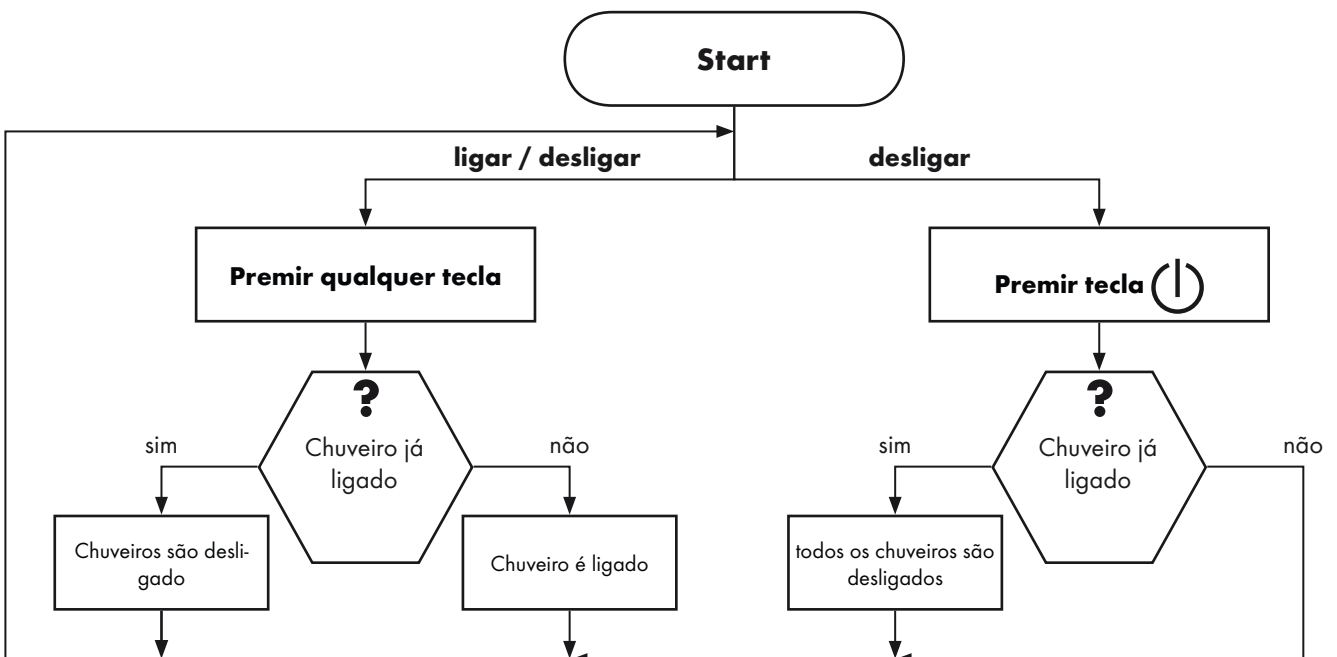

Português
Plano de utilizador

Raindance Rainfall
28411000

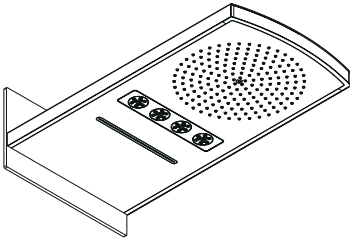

Modo de funcionamento

Aviso:
Todos os chuveiros têm que estar desligados

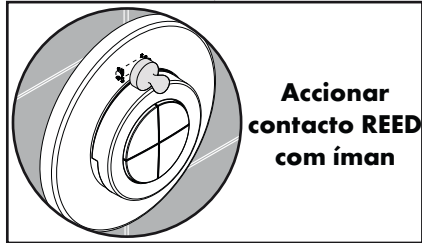

Modo de manutenção

Aviso:
Luz / ficha de codificação pisca 4x

Aviso:
Luz / ficha de codificação desliga

Aviso:
Luz / ficha de codificação pisca 2x

< 15 sek.

> 15 sek.

Clique duplo na tecla
⏻ ou ☀️

Clique duplo na tecla
☰

Modo de tempo máx. de funcionamento

Aviso:
Luz / ficha de codificação pisca no ciclo de 1 seg.

Modo de chuveiro

Aviso:
Luz / ficha de codificação pisca no ciclo de 2 seg.

< 15 sek.

> 15 sek.

< 15 sek.

> 15 sek.

Clique duplo na tecla
⏻ ou ☀️

Premir tecla
☰

Premir tecla
☷

Premir tecla
☂️

Clique duplo na tecla
⏻ ou ☀️

Premir tecla
☰

Tempos de funcionamento:
Chuveiros: 30 s
Luz: 30 min

Padrão:
Tempos de funcionamento:
Chuveiros: 60 s
Luz: 30 min

Tempos de funcionamento:
Chuveiros: 180 s
Luz: 30 min

Tempos de funcionamento:
Chuveiros + Luz: infinito

Padrão
Podem ser ligados no máx. 2 chuveiros

Conforto 1:
Todos os chuveiros podem ser ligados simultaneamente

Português
Plano de utilizador

Raindance Rainmaker
28403000 / 28404000

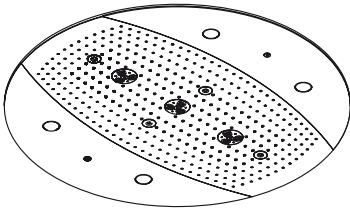

Modo de funcionamento

Aviso:
Todos os chuveiros têm que estar desligados



Modo de manutenção

Aviso:
Luz / ficha de codificação pisca 4x

Aviso:
Luz / ficha de codificação desliga

Aviso:
Luz / ficha de codificação pisca 2x

< 15 sek.

> 15 sek.

Clique duplo na tecla
⏻ ou ☀️

Clique duplo na tecla
☔

Modo de tempo máx. de funcionamento

Aviso:
Luz / ficha de codificação pisca no ciclo de 1 seg.

Modo de chuveiro

Aviso:
Luz / ficha de codificação pisca no ciclo de 2 seg.

< 15 sek.

> 15 sek.

< 15 sek.

> 15 sek.

Clique duplo na tecla
⏻ ou ☀️

Premir tecla
☔

Premir tecla
☔

Premir tecla
☔

Clique duplo na tecla
⏻ ou ☀️

Premir tecla
☔

Premir tecla
☔

Tempos de funcionamento:
Chuveiros: 30 s
Luz: 30 min

Padrão:
Tempos de funcionamento:
Chuveiros: 60 s
Luz: 30 min

Tempos de funcionamento:
Chuveiros: 180 s
Luz: 30 min

Tempos de funcionamento:
Chuveiros + Luz: infinito

Padrão
Podem ser ligados no máx. 2 chuveiros

Conforto 1:
Todos os chuveiros podem ser ligados simultaneamente

Conforto 2:
Maior quantidade de água só necessária para Rainmaker

Português Plano de especialista

Raindance Rainfall
28411000

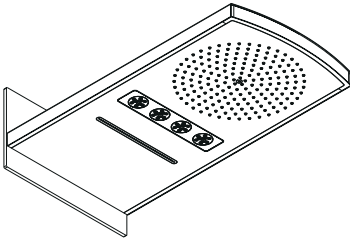

**Modo de funciona-
mento**

Aviso:
Todos os chuveiros têm que
estar desligados



Modo de manutenção

Aviso:
Luz / ficha de codificação
pisca 4x

Aviso:
Luz / ficha de codificação
pisca 2x

Aviso:
Luz / ficha de codificação
desliga

< 15 sek.

> 15 sek.

Premir qualquer tecla 1 x

**Clique duplo na
tecla**

**Clique duplo na
tecla**

Modo de registo

Modo de eliminação

Modo de apresentação

?

sim

○ emissor é conhecido?

não

Aviso:
Luz / ficha de codificação
pisca no ciclo de 0,5 seg.

Aviso:
Luz / ficha de codificação
pisca no ciclo de 4 seg.

< 15 sek.

> 15 sek.

< 15 sek.

> 15 sek.

Aviso:
Luz / ficha de
codificação
pisca 1x

?

sim

N.º dos emisso-
res conhecidos ≤ 3 peças

não

Aviso:
○ emissor mais
antigo conheci-
do é apagado

**Clique duplo
na tecla**
ou

**Premir
tecla**

Todos os
emissores são
apagados

○ emissor
utilizado é
apagado

**Clique duplo
na tecla**
ou

**Premir
tecla**

**Premir
tecla**

Apresentação
1 é iniciada

Apresentação
2 é iniciada

Apresentação
3 é iniciada

Premir qualquer tecla

Aviso:
Todos os chuveiros desligam

Aviso:
Luz / ficha de codifica-
ção pisca 3x

Novo emissor é configurado
resp., memorizado

Português Plano de especialista

Raindance Rainmaker
28403000 / 28404000

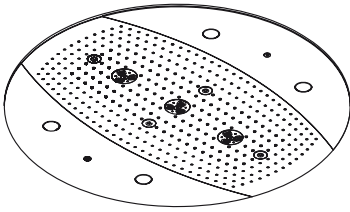

Modo de funcionamento

Aviso:
Todos os chuveiros têm que estar desligados

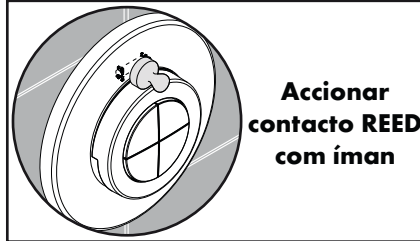

Modo de manutenção

Aviso:
Luz / ficha de codificação pisca 4x

Aviso:
Luz / ficha de codificação pisca 2x

Aviso:
Luz / ficha de codificação desliga

< 15 sek.

> 15 sek.

Premir qualquer tecla 1 x

Clique duplo na tecla

Clique duplo na tecla

Modo de registo

Modo de eliminação

Aviso:
Luz / ficha de codificação pisca no ciclo de 0,5 seg.

Modo de apresentação

Aviso:
Luz / ficha de codificação pisca no ciclo de 4 seg.

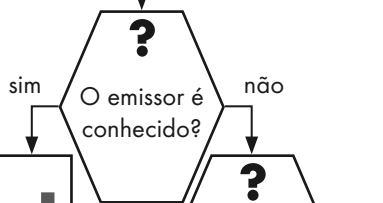

Aviso:
Luz / ficha de codificação pisca 1x

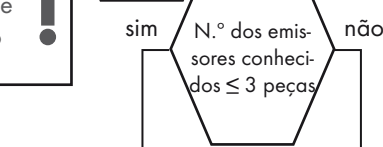

Aviso:
○ emissor mais antigo conhecido é apagado

< 15 sek.

> 15 sek.

< 15 sek.

> 15 sek.

Clique duplo na tecla
ou

Premir tecla

Todos os emissores são apagados

○ emissor utilizado é apagado

Clique duplo na tecla
ou

Premir tecla

Premir tecla

Apresentação 1 é iniciada

Apresentação 2 é iniciada

Apresentação 3 é iniciada

Premir qualquer tecla

Aviso:
Todos os chuveiros desligam

Aviso:
Luz / ficha de codificação pisca 3x

Novo emissor é configurado resp., memorizado

Normy i wytyczne:

Zastosowanie produktu zapewnia się na podstawie następujących wytycznych:

- EN 15200
- EN 60335-2-105



Wskazówki bezpieczeństwa:

- Prysznic może być używany tylko do kąpieli, higieny i czyszczenia ciała.
- Dzieci nie mogą używać systemu pryszniców bez nadzoru.
- Zarówno dzieci, jak i dorośli z fizycznymi, psychicznymi i/lub sensorycznymi ograniczeniami nie mogą korzystać z prysznica bez opieki. Osoby znajdujące się pod wpływem alkoholu lub narkotyków nie mogą korzystać z prysznica.
- Należy unikać kontaktu strumienia wypływającego z głowicy z wrażliwymi częściami ciała (np. oczami). Należy zachowywać odpowiednią odległość pomiędzy głowicą a ciałem.
- Znaczne różnice ciśnień na dopływach ciepłej i zimnej wody muszą zostać wyrównane.



Przyłącze elektryczne:

- Prace instalacyjne i kontrolne mogą być przeprowadzane jedynie przez wykwalifikowanego elektryka, przestrzegając przepisów z VDE 0100 część 701 i IEC 60364-7-701.
- Dla przyłącza elektrycznego wymagane jest jedynie gniazdo wtykowe. Zasilanie elektryczne odbywa się przy użyciu zewnętrznego transformatora.
- W najbliższej odległości nie może być żadnych materiałów łatwopalnych.
- Temperatura otoczenia nie może przekraczać 50°C.
- Całość zasilania elektrycznego odbywa się przy użyciu przyłącza prądu zmiennego 230V/N/PE/50Hz.
- Zabezpieczenie instalacji musi mieć miejsce przy użyciu zabezpieczenia różnicowego (RCD/ FI) z różnicą pomiarów wynoszącą ≤ 30 mA.
- Jeżeli wymagane jest wyrównanie potencjałów, wówczas powinno ono być wykonane przez klienta.
- Przy instalacji elektrycznej należy przestrzegać odpowiednich przepisów krajowych i europejskich w obowiązującej wersji.
- Należy zapewnić, by produkt można było odłączyć od sieci. Zapewnia się to albo przy użyciu wolno dostępnej wtyczki albo za pomocą wyłącznika wszystkich biegunów zgodnie z EN 60335-1 ust. 24.3.



Montaż: (patrz strona 303)

- Uwaga! Armatura musi być zamontowana, przepłukana i wypróbowana według obowiązujących norm. (Instalacja zgodnie z EN 1717) Patrz Instrukcja montażu Raindance Rainfall 28411000 Raindance Rainmaker 28403000 / 28404000 / 28417000 / 28418000
- Wszystkie prace mogą być przeprowadzone jedynie w stanie pozbawionym napięcia.
- Korpus 15941180 można zamontować tylko pionowo! Montaż z pierścieniem nastawnym (A) możliwy jest tylko w obszarze przednim i środkowym!
- Wszystkie komponenty muszą pozostać dostępne.

Dane techniczne:

Ciśnienie robocze::	maks. 1 MPa
Zalecane ciśnienie robocze:	0,1 - 0,5 MPa
Ciśnienie próbne:	1,6 MPa
(1 MPa = 10 bary = 147 PSI)	
Temperatura wody gorącej::	maks. 80° C
Zalecana temperatura wody gorącej:	65° C
Wymiary przyłącza:	G 3/4
Przyłącza Wejście:	Woda zmieszana
Swobodny przepływ przy 0,3 MPa:	
1 Odbiornik:	35 l/min
2 Odbiornik:	45 l/min



Wyposażenie: (patrz strona 84)



Wymiary: (patrz strona 292)



Przykłady montażowe Raindance Rainfall: (patrz strona 295)



Przykłady montażowe Raindance Rainmaker: (patrz strona 299)



Obsługa: (patrz strona 86)

- W przypadku awarii 230 V napięcia zasilającego nie można uruchomić prysznica.
- Produkt nie jest przewidziany do zastosowania w połączeniu z łaźnią parową!



Czyszczenie Sitko: (patrz strona 309)





























Części zamienne (patrz strona 311)

Montaż patrz strona 303

Polski Informacje techniczne

Usterka	Przyczyna	Pomoc
Brak funkcji	<ul style="list-style-type: none"> - Brak napięcia - Uszkodzony transformator zestawu podstawowego - Odbiornik umieszczony w niewłaściwym miejscu / uszkodzony - Nadajnik nie skalibrowany / uszkodzony 	<ul style="list-style-type: none"> - Zapewnić zasilanie elektryczne - Wymenić transformator - Zmienić pozycję odbiornika wzgl. wymienić odbiornik - Zaprogramować / wymienić nadajnik
Nie można skonfigurować trybu roboczego	<ul style="list-style-type: none"> - Styk kontaktronowy nie umieszczony na właściwej pozycji za rozetą - Uszkodzony styk kontaktronowy 	<ul style="list-style-type: none"> - Umieścić styk kontaktronowy przy rozecie - Wymenić przewód łączący zawór elektromagnetyczny
Brak funkcji świetlnej	<ul style="list-style-type: none"> - Nie podłączony / uszkodzony transformator funkcji Rainmaker - Nieodpowiednie / uszkodzone przewody przełącznika świetlnego 	<ul style="list-style-type: none"> - Zapewnić zasilanie elektryczne transformatora / wymienić transformator - Sprawdzić / wymienić połączenia i przełącznik świetlny
Odbiorniki wyłączają się same	<ul style="list-style-type: none"> - Czas pracy ustawiony w trybie programu 	<ul style="list-style-type: none"> - Przedłużyć czas zwłoki w trybie serwisowym / wyłączyć
Nieszczelna armatura	<ul style="list-style-type: none"> - Zanieczyszczony / uszkodzony zawór elektromagnetyczny 	<ul style="list-style-type: none"> - Wyczyścić / wymienić membranę zaworu elektromagnetycznego
Za mały przepływ	<ul style="list-style-type: none"> - Zanieczyszczony filtr sitowy po stronie wejścia 	<ul style="list-style-type: none"> - Oczyszczyć / wymienić sitko

Symboli

	Podłączenie wody DN 20 Ciepła woda		Transformator		Wyrównanie potencjału
	Podłączenie wody DN 20 Zimna woda		Odbiornik		wszystko wyłączone
	Otworzyć wodę		Wtyczka kodująca		Światło
	Zakręcić wodę		230V		Rain
	Od • możliwe jest funkcjonowanie.		12V		Whirl
	Wydajność odpływu musi być wyższa niż 50 l/min.		Rura osłonowa do prowadzenia przewodów		Rainflow
	Odpływ		Sterowanie oświetleniem 27189000 (Nie jest częścią dostawy!)		Rain AIR XXL
	Raindrain		Przełącznik świetlny Rainmaker		Rain AIR
	Środek brodzika		Transformator Rainmaker		Silikon (neutralny)
			Przyłącze 12 V na światło zainstalowane przez klienta (maks. 80 W)		

Montaż patrz strona 303

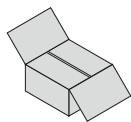

Polski Wyposażenie

Transformator:

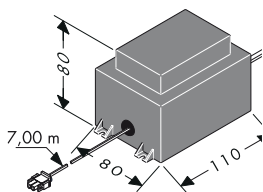

Moc zewnętrznego transformatora wynosi 50 VA. Transformator musi być zainstalowany w suchym otoczeniu (strefa ochronna 3). Transformator można zamontować wraz z odbiornikiem w obudowie z tworzywa sztucznego, z uwzględnieniem EN/IEC 60335-1. (wymiary ok. 250 x 160 x 92 mm, nie jest częścią dostawy.) Dołączony kabel umożliwia instalację transformatora w odległości do 7,00 m od odbiornika. W tym celu należy przewieźć rurkę kablową EN35 (nie jest częścią dostawy). Rurkę kablową należy zamocować co najmniej co 500 mm, a promień gięcia musi być większy niż 100 mm.

Przewód wtórny transformatora o dług. ok. 7,00 m nie może zostać skrócony. Niepotrzebna reszta

długości przewodu powinna zostać zwinięta w pobliżu transformatora bezpieczeństwa. Uszkodzonego przewodu przyłączeniowego nie można zastąpić. Transformatora nie można już wtedy używać.

Uszkodzonego przewodu przyłączeniowego nie można zastąpić. W przypadku, gdy uszkodzony jest przewód sieciowy, fachowiec elektryk musi go wymienić wraz z transformatorem.

Przełącznik świetlny:

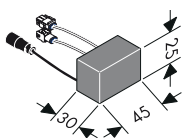

(tylko przy wariantach z wbudowanym światłem)

Przełącznik świetlny może być obciążony maksymalnie 12 V AC / 80 W.

Praca w sieci 230 V jest niedozwolona.

Sterowanie oświetleniem:

27189000

(Nie jest częścią dostawy)

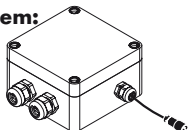

(iControl mobile 15944000)

Sterownik świateł należy podłączyć do wersji z zewnętrznym źródłem światła. Sterownik świateł musi być zawsze dostępny.

Wtyczka kodująca:

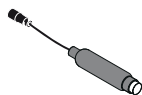

(Raindance Rainfall 28411000 / Raindance Rainmaker 28403000)

Wtyczkę kodującą należy podłączyć do wersji bez światła.

Gdy przy wersjach bez światła aktywowany jest tryb obsługi, wówczas dioda świecąca wtyczki kodującej pokazuje optyczne potwierdzenia odbioru.

Wtyczka kodująca musi być zawsze dostępna.

Przewód przyłączeniowy Blok zaworu elektromagnetycznego / Przewód przyłączeniowy Światło:



Nie wolno skracać 7,50 m długości przewodu bloku zaworu elektromagnetycznego, ani 10,00 m światłowodu. Niepotrzebna reszta długości przewodu powinna zostać zwinięta w pobliżu odbiornika.

Przewód bloku zaworu elektromagnetycznego i przewód światłowodu mogą zostać położone tylko w dostarczonej rurce kablowej (EN 20).

Rurkę kablową należy zamocować co najmniej co 500 mm, a promień gięcia musi być większy niż 100 mm.

Uwaga: W rurkach kablowych na przewód zaworu elektromagnetycznego i przewód światłowodu nie można położyć przewodów elektrycznych, których napięcie jest wyższe niż 12 V.

Montaż patrz strona 303

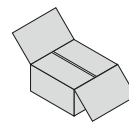

Odbiornik:

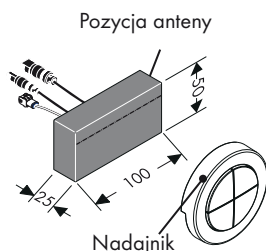

Odbiornik powinien w miarę możliwości zostać zamontowany w tym samym pomieszczeniu, jak przysznice.

Jeżeli by to nie było możliwe, wówczas można zamontować odbiornik również w pomieszczeniu, który graniczy z przysznicem.

Odbiornika nie można zamontować w obudowie metalowej, ponieważ sygnały radiowe nadajnika są ekranowane. Poza tym należy zwrócić uwagę na to, by w pobliżu miejsca montażu odbiornika było możliwie niewiele ekranowych części meta-

lowych.

W celu zapewnienia rozpoznania sygnału radiowego antena odbiornika powinna w miarę możliwości być zwrócona w kierunku nadajnika.

Nadajnik:



Przy dostawie nadajnik jest już wczytany w odbiornika. Nadajnika można przyporządkować do odbiornika za pomocą identycznego numeru serii. Dodatkowe nadajniki wzgl. nadajniki zakupione w późniejszym czasie muszą być wczytane. Można maksymalnie wczytać wzgl. zapisać maksymalnie cztery nadajniki. (patrz strona 90/91 Tryb zameldowania).

Nadajnik posiada częstotliwość radiową 868,3 MHz.

Wskazówka: Odbiornik i nadajnik posiadają zasięg wynoszący ok. 10,00 m. Zasięg zależy od tego, jak mocno tłumione są sygnały radiowe między nadajnikiem a odbiornikiem.

Wskazówka: Ze względów bezpieczeństwa należy nadajnik używać jedynie w zasięgu wzroku systemu przyszniców. W przeciwnym wypadku można włączyć nieopatrnie wodę.

Wskazówka: Właściwe postępowanie przy wymianie uszkodzonego nadajnika na nowy:

1. Usunąć wszystkie nadajniki. (ryb zameldowania ⇒ Tryb usuwania).
2. Wczytać wszystkie nadajniki, poza uszkodzonym nadajnikiem. (Tryb serwisowy ⇒ Tryb zameldowania).

Material	Tłumienie
Drewno, gips, szkło (niepowleczone, bez metalu)	0 - 10 %
Cegła, płyty wiórowe	5 - 35 %
Beton z uzbrojeniem ze żelaznym	10 - 90 %
Metal, laminat aluminiowy	90 - 100 %

Magnes:



W celu aktywacji trybu obsługowego magnes uruchamia zestaw REED (za rozetką maskującą). (patrz strona 88/89, Tryb serwisowy).

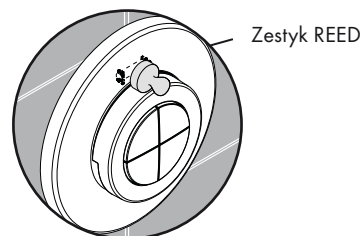

Raindance Rainfall

28411000

iControl mobile

15940180 / 15942000

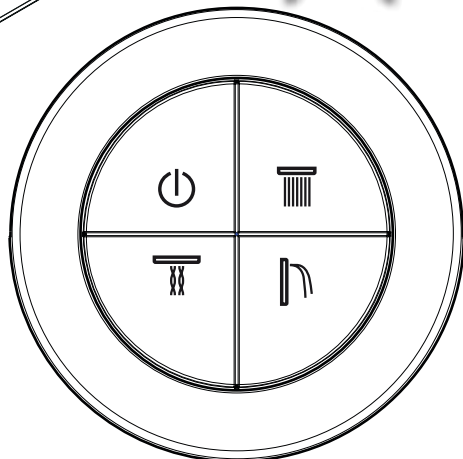
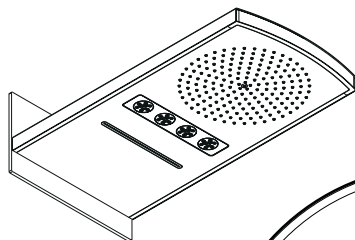

Raindance Rainfall

28411000

iControl mobile

15941180 / 15944000

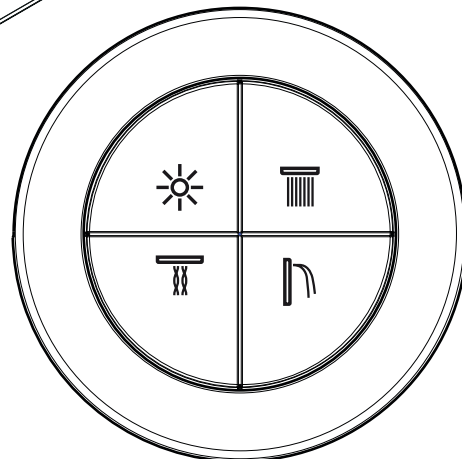
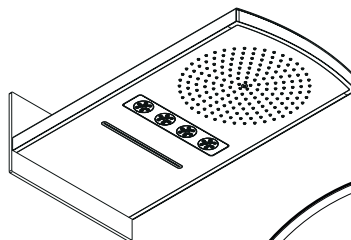

Raindance Rainmaker

28403000

iControl mobile

15940180 / 15943000

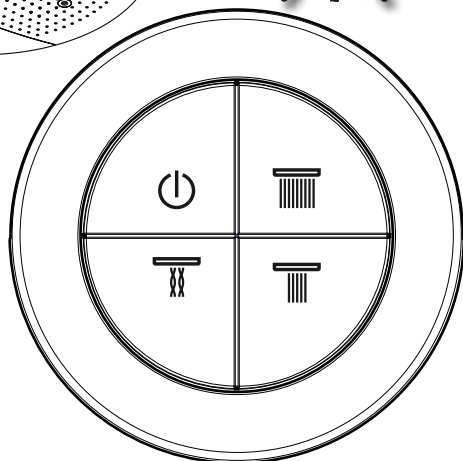
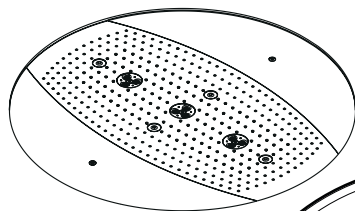

Raindance Rainmaker

28404000

iControl mobile

15941180 / 15945000

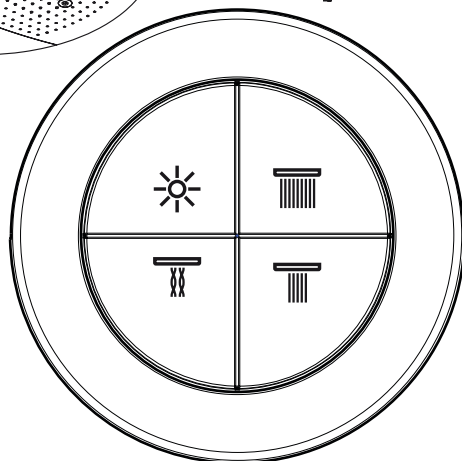
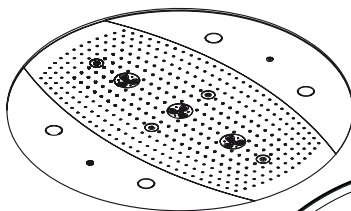

wszystko wyłączone



Rain



Whirl



Rainflow



Światło



Rain AIR XXL



Rain AIR

Montaż patrz strona 303

Włączyć i wyłączyć prysznice i światło:

(Funkcja standardowa ze światłem)

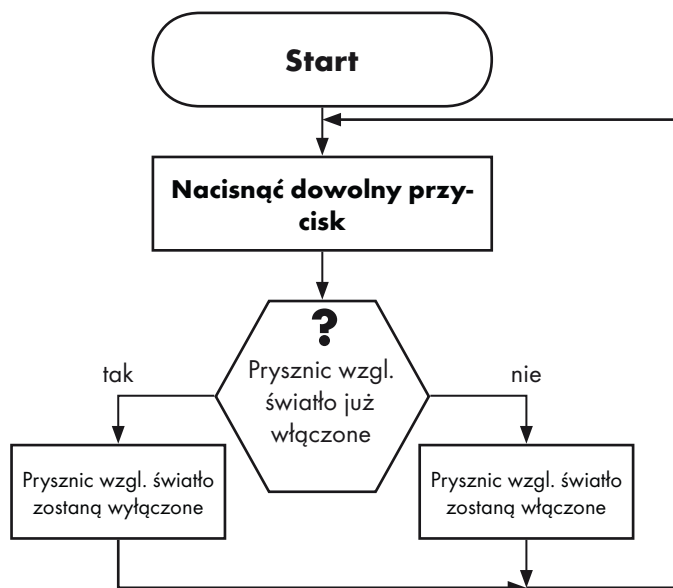

Włączyć i wyłączyć prysznice:

(Funkcja standardowa bez światła)

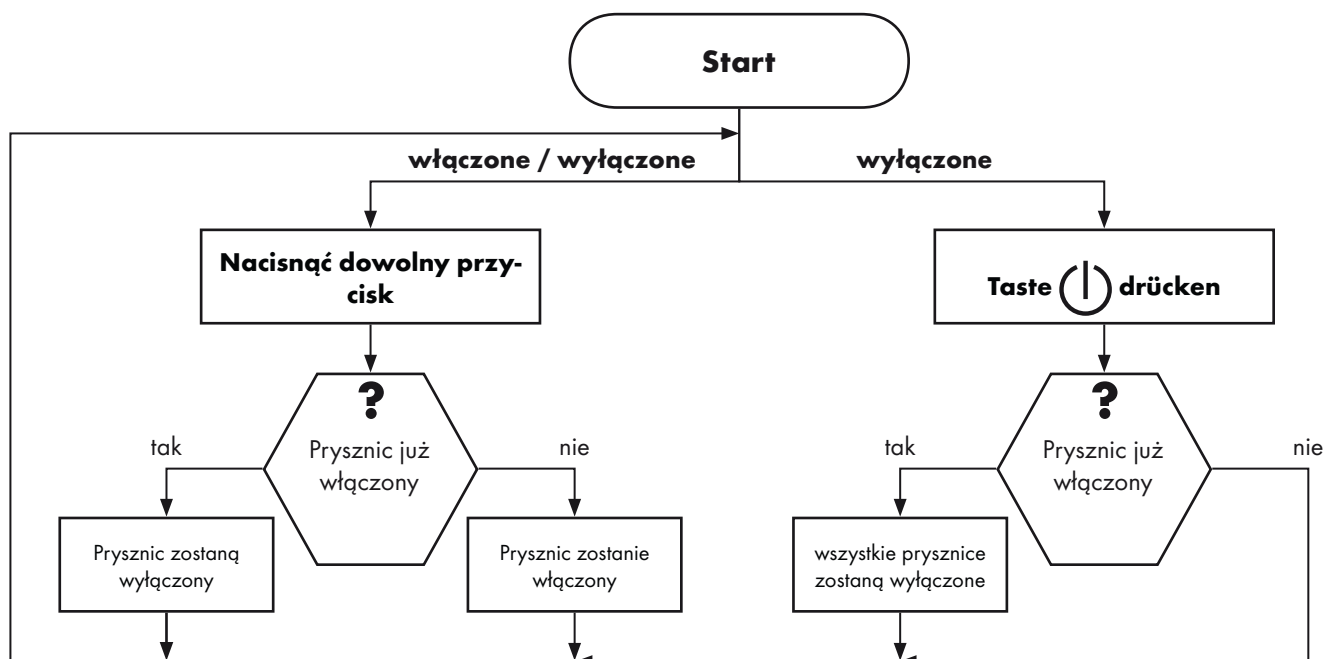

Montaż patrz strona 303

Polski
Poziom operatora

Raindance Rainfall
28411000

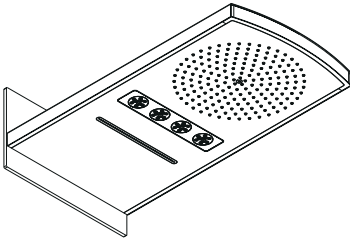

Tryb pracy

Wskazówka:
Wszystkie prysznice muszą być wyłączone



Tryb serwisowy



Wskazówka:
Światło / wtyczka kodująca miga 4x

Wskazówka:
Światło / wtyczka kodująca wygasa

Wskazówka:
Światło / wtyczka kodująca miga 2x

< 15 sek.

> 15 sek.

Kliknąć dwukrotnie przycisk  lub 

Kliknąć dwukrotnie przycisk 

Tryb maksymalnego czasu eksploatacji

Wskazówka:
Światło / wtyczka kodująca miga co 1 sek.

Tryb prysznica

Wskazówka:
Światło / wtyczka kodująca miga co 2sek

< 15 sek.

> 15 sek.

< 15 sek.

> 15 sek.

Nacisnąć przycisk
 lub 

Nacisnąć przycisk

Nacisnąć przycisk

Nacisnąć przycisk

Nacisnąć przycisk
 lub 

Nacisnąć przycisk

Czasy eksploatacji:
Prysznice: 30 s
Światło: 30 min

Standard: Czasy eksploatacji:
Prysznice: 60 s
Światło: 30 min

Czasy eksploatacji:
Prysznice: 180 s
Światło: 30 min

Czasy eksploatacji:
Prysznice + światło: w nieskończoność

Standard
maks. można włączyć 2 prysznice

Komfort 1:
wszystkie prysznice można włączyć jednocześnie

Polski Poziom operator

Raindance Rainmaker
28403000 / 28404000

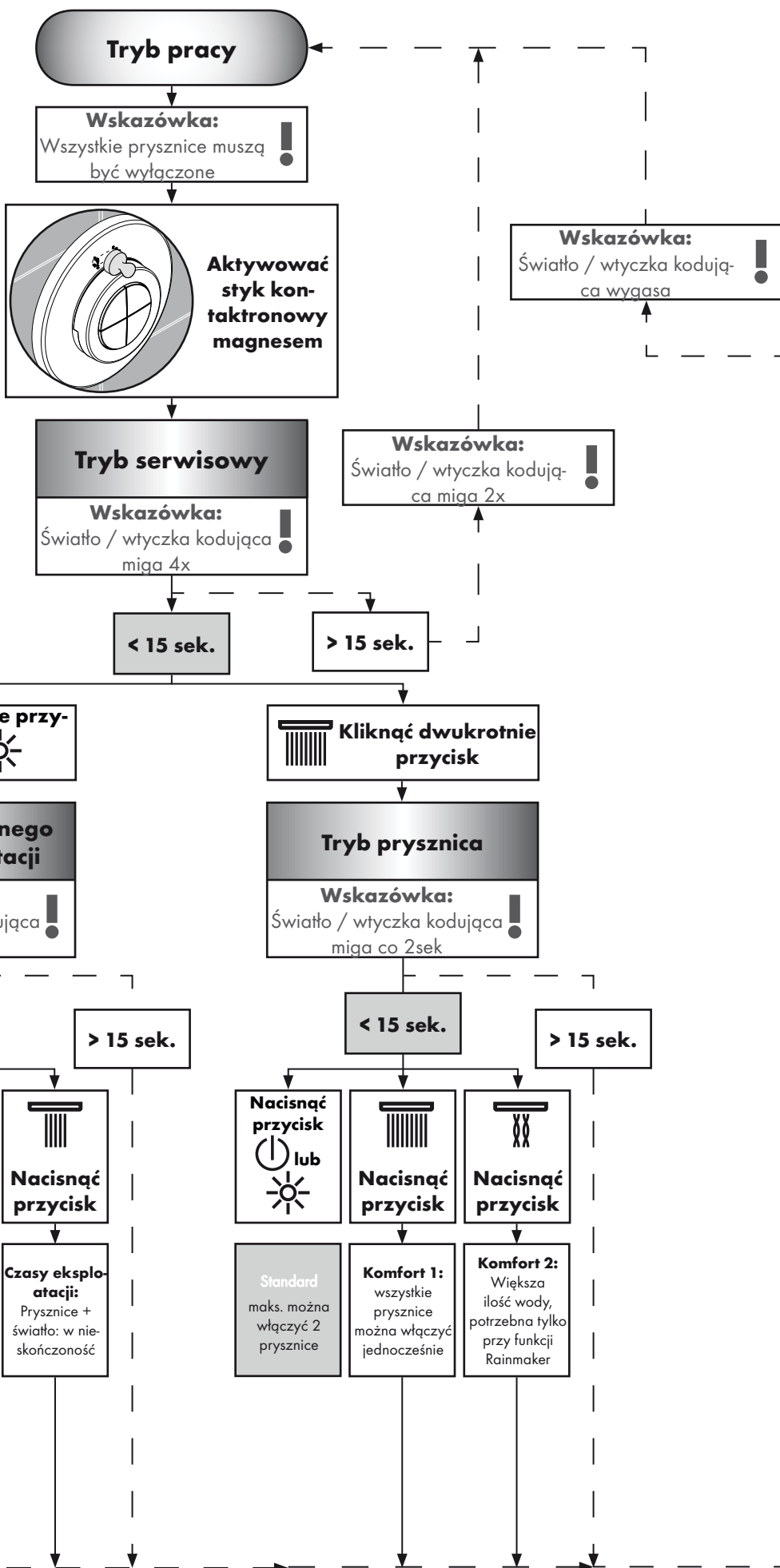
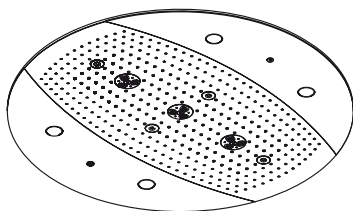

**Polski
Poziom eksperta**

Raindance Rainfall
28411000

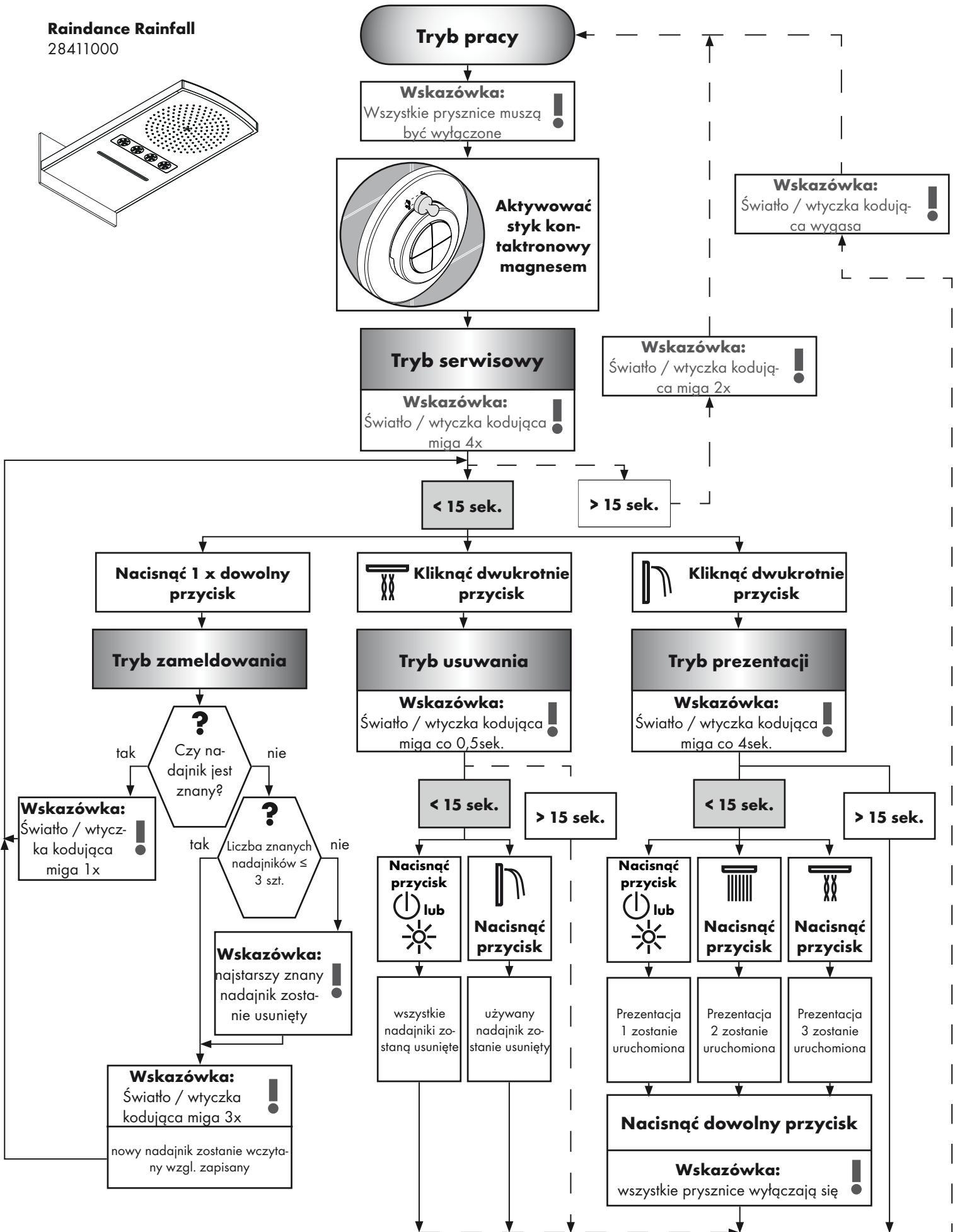
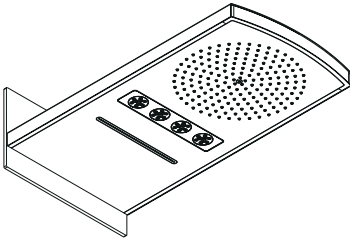

**Polski
Poziom eksperta**

Raindance Rainmaker
28403000 / 28404000

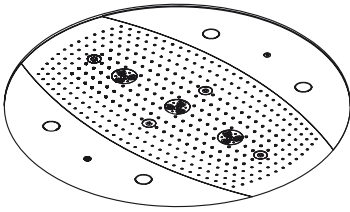

Tryb pracy

Wskazówka:
Wszystkie prysznice muszą być wyłączone



Tryb serwisowy
Wskazówka:
Światło / wtyczka kodująca miga 4x

Wskazówka:
Światło / wtyczka kodująca wygasa

Wskazówka:
Światło / wtyczka kodująca miga 2x

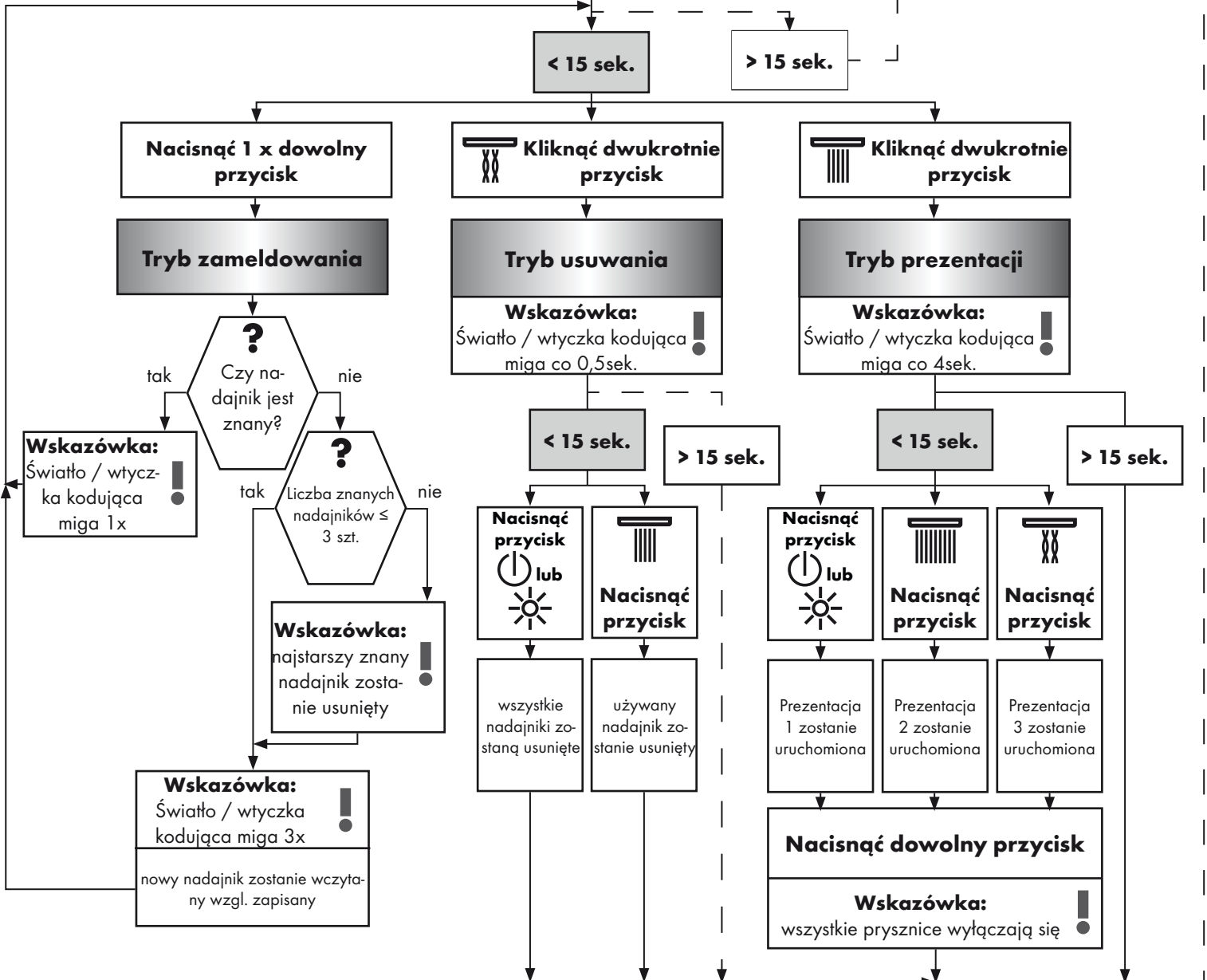

Normy a směrnice:

Použití výrobku je zajištěno prostřednictvím následujících směrnic:

- EN 15200
- EN 60335-2-105



Bezpečnostní pokyny:

- Produkt smí být používán pouze ke koupání a za účelem tělesné hygieny.
- Děti nesmí používat sprchový systém bez dozoru.
- Děti a dospělí osoby s tělesným, duševním a / nebo smyslovým postižením nesmí sprchový systém používat bez dozoru. Osoby pod vlivem alkoholu nebo drog nesmí sprchový systém používat.
- Je nutné zabránit kontaktu vodních paprsků sprchy s měkkými částmi těla (např. očima). Je nutné dodržovat dostatečný odstup mezi sprchou a tělem.
- Je nutné vyrovnat velké rozdíly tlaku mezi přípoji studené a teplé vody.



Elektrické připojení:

- Instalační práce a přezkoušení musí být provedeno autorizovaným elektrotechnickým odborníkem za zohlednění směrnic VDE 0100, část 701 a IEC 60364-7-701.
- Pro elektrické zapojení je potřeba pouze jedna zásuvka. Napájení probíhá přes externí transformátor.
- Lehce vznětlivé materiály se nesmí nikdy dostat do bezprostřední blízkosti.
- Okolní teplota nesmí být vyšší než 50 °C.
- Celkové napájení probíhá přes napojení na střídavý proud 230V/N/PE/50Hz.
- Přívod musí být chráněn proudovým chráničem pro chybový proud (RCD/ FI) s mírným rozdílovým proudem ≤ 30 mA.
- Je-li potřeba vyrovnání napětí, musí být zajištěno stavitelem.
- Při elektroinstalaci musíte dodržet příslušné předpisy VDE a místní předpisy energetických podniků, vždy v platném znění.
- Musí být zajištěno, aby bylo možné výrobek odpojit od sítě. Buď volně přístupnou zástrčkou nebo vícepólovým vypínačem podle EN 60335-1 odst. 24.3.



Montáž: (viz strana 303)

- **Pozor!** Armatura se musí montovat, proplachovat a testovat podle platných norem. (Instalace podle normy EN 1717)
Viz montážní návod:
Raindance Rainfall 28411000
Raindance Rainmaker 28403000 / 28404000 / 28417000 / 28418000
- Veškeré práce se smí provádět pouze v beznapěťovém stavu.
- Hlavní těleso 15941180 lze namontovat pouze vertikálně (ve svislé poloze)!
Montáž s regulačním kroužkem (A) je možná jen v přední a střední oblasti!
- Všechny komponenty musí zůstat přístupné.

Technické údaje:

Provozní tlak::	max. 1 MPa
Doporučený provozní tlak:	0,1 - 0,5 MPa
Zkušební tlak::	1,6 MPa
(1 MPa = 10 bar = 147 PSI)	
Teplota horké vody::	max. 80° C
Doporučená teplota horké vody:	65° C
Rozteč připojení:	G 3/4
Přípoje Vstup:	Záměsová voda
Volný průtok při 0,3 MPa	
1 Spotřebič:	35 l/min
2 Spotřebič:	45 l/min



Příslušenství: (viz strana 94)



Rozměry: (viz strana 292)



Příklady montáže Raindance Rainfall: (viz strana 295)



Příklady montáže Raindance Rainmaker: (viz strana 299)



Ovládání: (viz strana 96)

- Při výpadku síťového napětí 230 V nelze zařízení sprchy provozovat.
- Výrobek není určen k použití ve spojení s parní lázní!



Čištění Filtrační sítka: (viz strana 309)





























Náhradní díly (viz strana 311)

Česky

Technické informace

Porucha	Příčina	Odstranění
Žádná funkce	<ul style="list-style-type: none"> - Žádné napájení el. energií - Trafo základní sady defektní - Přijímač nevhodně umístěn / defektní - Vysílač nebyl zaučen / je defektní 	<ul style="list-style-type: none"> - Zajištěte napájení el. energií - Vyměňte trafo - Změňte polohu přijímače popř. vyměňte přijímač - Zaučte / vyměňte vysílač
Provozní režim nelze konfigurovat	<ul style="list-style-type: none"> - Jazýčkový kontakt se nenachází ve vhodné poloze za rozetou - Jazýčkový kontakt je vadný 	<ul style="list-style-type: none"> - Umístěte jazýčkový kontakt na rozetu - Vyměňte přípojovací vedení elektromagnetického ventilu
Žádná funkce světla	<ul style="list-style-type: none"> - Trafo Rainmaker není zasunuto / je vadné - Přívodní vedení světelného relé vadné / defektní 	<ul style="list-style-type: none"> - Zajištěte napájení trafo el. energií / vyměňte trafo - Zkontrolujte / vyměňte propojovací vedení a světelná relé
Spotřebiče se vypínají samočinně	<ul style="list-style-type: none"> - Doba chodu uložena v programovém režimu 	<ul style="list-style-type: none"> - Prodlužte / vypněte dobu doběhu v servisním režimu
Armatura netěsná	<ul style="list-style-type: none"> - Elektromagnetický ventil znečištěn / defektní 	<ul style="list-style-type: none"> - Vyčistěte / vyměňte membránu elektromagnetického ventilu
Příliš malý průtok	<ul style="list-style-type: none"> - Sítko pro zachytávání nečistot na vstupní straně znečištěno 	<ul style="list-style-type: none"> - vyčistit / vyměnit lapač nečistot

Symbolem

	Připojení vody DN 20 Teplá voda		transformátor		Vyrovnaní potenciálů
	Připojení vody DN 20 Studená voda		Přijímač		vše vypnuto
	Vodu zapojit		Kódovaný konektor		Světlo
	Vodu odpojit		230V		Rain
	Od • je zaručená funkce		12V		Whirl
	Odtokový výkon musí být vyšší než 50 l/min.		Ochranná trubka		Rainflow
	Odtok		Řízení osvětlení 27189000 (není součástí dodávky)		Rain AIR XXL
	Raindrain		Světelné relé Rainmaker		Rain AIR
	Střed sprchové vany		transformátor Rainmaker		Silikon (bez kyseliny octové!)
			Ze strany stavby předinstalovaná 12 V přípojka pro světlo (max. 80 W)		

Montáž viz strana 303

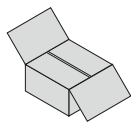

Česky Příslušenství

Transformátor:

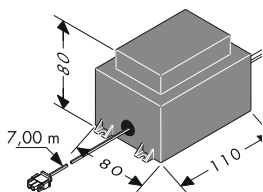

Výkon externího transformátoru obnáší 50 VA. Transformátor musíte instalovat v suchém pásmu (ochranná zóna 3). Transformátor lze společně s přijímačem zabudovat do plastického pouzdra za zohlednění směrnic EN/IEC 60335-1. (rozměry cca 250 x 160 x 92 mm, není v rozsahu dodávky.) Kabel obsažený v dodávce umožňuje instalaci transformátoru až do vzdálenosti 7 m od přijímače. K tomu je nutné si připravit prázdnou ochrannou trubku EN35 (není v rozsahu dodávky). Ochranná trubka musí být alespoň každých 500 mm připevněna a poloměr ohybu musí být větší než 100 mm.

Sekundární, cca 7 m dlouhé vedení transformátoru se nesmí zkracovat. Nevyužitou část vedení je třeba

umístit do blízkosti bezpečnostního transformátoru. Poškozené přívodní vedení se nesmí nahrazovat. Transformátor poté nelze dále provozovat.

Poškozené přívodní vedení se nesmí nahrazovat. Při vadném připojovacím síťovém vedení musí být vedení včetně traťů vyměněno odborníkem v oblasti elektrotechniky.

Světelné relé:

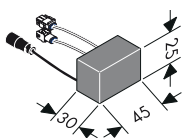

(pouze u variant s integrovaným světlem)

Světelné relé smí být zatíženo maximálně 12 V AC / 80 W.

Provoz na síti 230 V není přípustný.

Řízení osvětlení:

27189000

(není součástí dodávky)

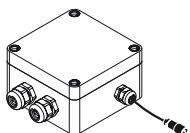

(iControl mobile 15944000)

Ovládání osvětlení musí být u variant s externím světelným zdrojem připojeno.

Ovládání osvětlení musí být vždy přístupné.

Kódovaný konektor:

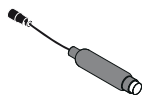

(Raindance Rainfall 28411000 / Raindance Rainmaker 28403000)

Kódovaný konektor musí být připojen u variant bez světla.

Když je režim údržby u variant bez světla aktivován, zobrazuje LED dioda kódovaného konektoru optická zpětná hlášení.

Kódovaný konektor musí být vždy přístupný.

Přívodní vedení Modulu elektromagnetického ventilu / Přívodní vedení Světlo:



7,50 m dlouhé vedení modulu elektromagnetického ventilu jako i 10,00 m dlouhé světelné vedení se nesmí zkracovat. Nevyužitou část vedení je třeba umístit do blízkosti přijímače.

Vedení modulu elektromagnetického ventilu a světelné vedení lze pokládat pouze v ochranné trubce obsažené v dodávce (EN 20).

Ochranná trubka musí být alespoň každých 500 mm připevněna a poloměr ohybu musí být větší než 100 mm.

Pozor: V ochranných trubkách pro vedení modulu elektromagnetického ventilu a světelného vedení nesmí být uložena žádná elektrická vedení, která vedou napětí vyšší než 12 V.

Montáž viz strana 303

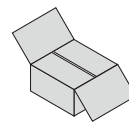

Přijímač:

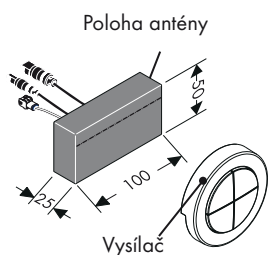

Přijímač by měl být přednostně namontován ve stejné místnosti jako zařízení sprchy.

Jestliže to není možné, může být přijímač namontován také v místnosti, která sousedí s místností se zařízením sprchy.

Přijímač nelze montovat do kovového pouzdra, protože by docházelo ke stínění rádiových signálů vysílače. Dále je třeba dbát na to, aby se v blízkosti místa montáže přijímače nacházelo co možná nejméně kovových částí způsobujících stínění.

Pro optimální příjem rádiových signálů je třeba

anténu přijímače nasměrovat co možná nejvíce na vysílač.

Vysílač:



Při expedici je signál vysílače již načten v přijímači. Pomocí shodných sériových čísel lze vysílač přiřadit k přijímači.

Dodatečně popř. dodatečně zakoupené vysílače se musí nejprve načíst. Lze načíst popř. uložit maximálně 4 vysílače. (viz strana 100/101 Přihlašovací režim).

Frekvence rádiového signálu vysílače je 868,3 MHz.

Upozornění: Přijímač a vysílač mají dosah cca 10 m. Dosah je závislý na síle tlumení rádiového signálu mezi vysílačem a přijímačem.

Upozornění: Z bezpečnostních důvodů používejte vysílač pouze v dosahu viditelnosti sprchového systému. Jinak by mohla být omylem zapnuta voda.

Upozornění: Správný postup při výměně defektního vysílače za nový:

1. Vymazat všechny vysílače. (Přihlašovací režim ⇒ Režim mazání).
2. Opětovně načíst všechny vysílače kromě defektního. (Servisní mazání ⇒ Přihlašovací režim).

Materiál	Tlumení
Dřevo, sádra, sklo (bez povrchové úpravy, bez kovů)	0 - 10 %
Cihly, lisované dřevotřískové desky	5 - 35 %
Beton vyztužený železem	10 - 90 %
Kovy, hliníkové opláštění	90 - 100 %

Elektromagnet:



Pro aktivaci servisního režimu musí magnet aktivovat kontakt REED (za rozetou). (viz strana 98/99, Servisní mazání).

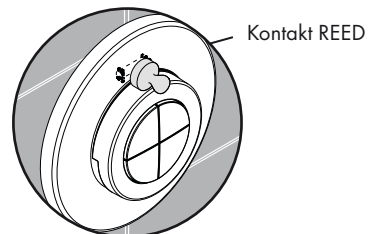

Raindance Rainfall

28411000

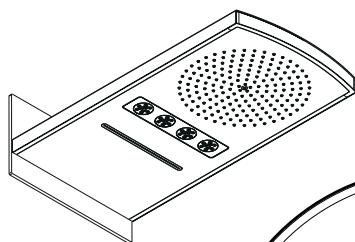

iControl mobile

15940180 / 15942000

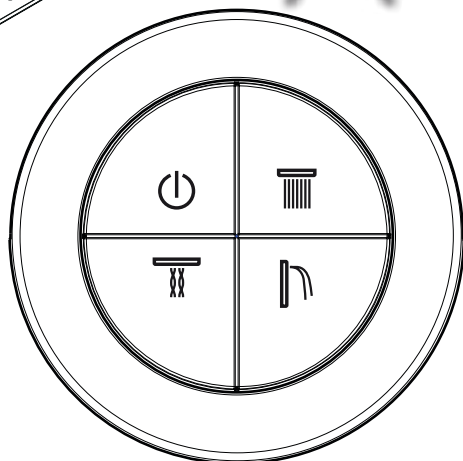

Raindance Rainfall

28411000

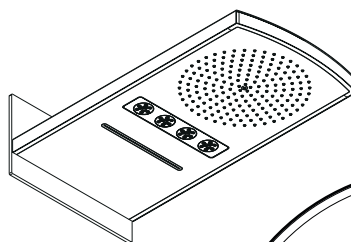

iControl mobile

15941180 / 15944000

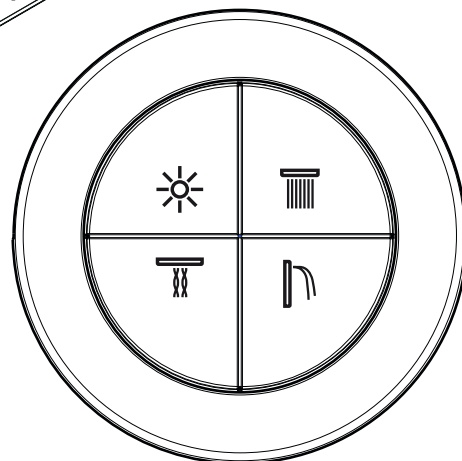

Raindance Rainmaker

28403000

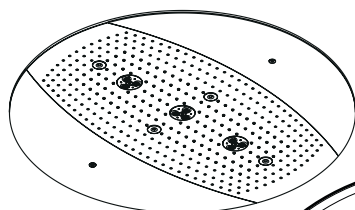

iControl mobile

15940180 / 15943000

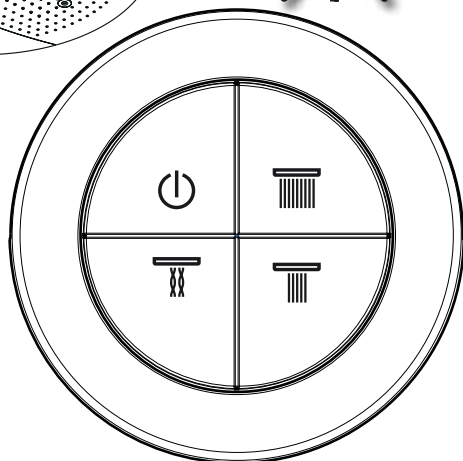

Raindance Rainmaker

28404000

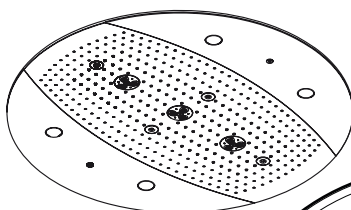

iControl mobile

15941180 / 15945000

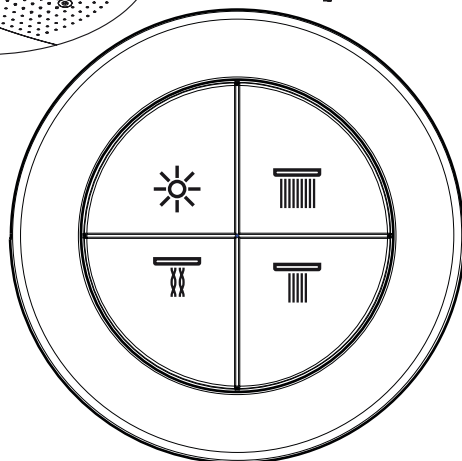

vše vypnuto



Rain



Whirl



Rainflow



Světlo



Rain AIR XXL



Rain AIR

Montáž viz strana 303

Sprchu a světlo zapnout a vypnout:

(Standardní funkce se světlem)

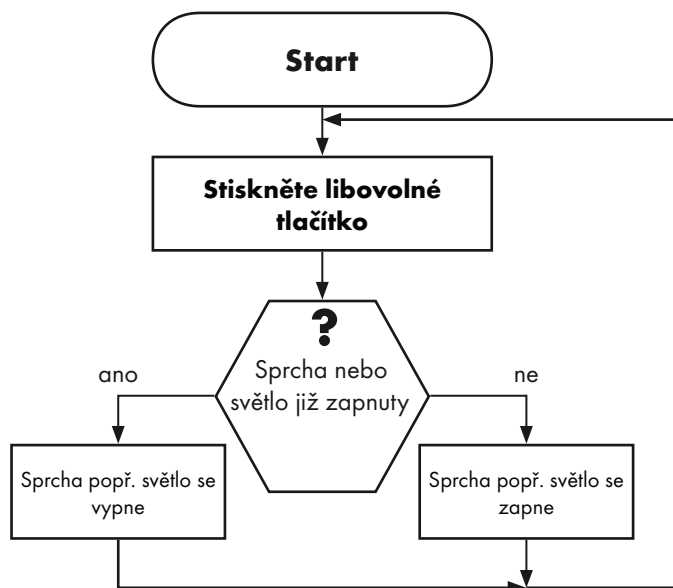

Sprchu zapnout a vypnout:

(Standardní funkce bez světla)

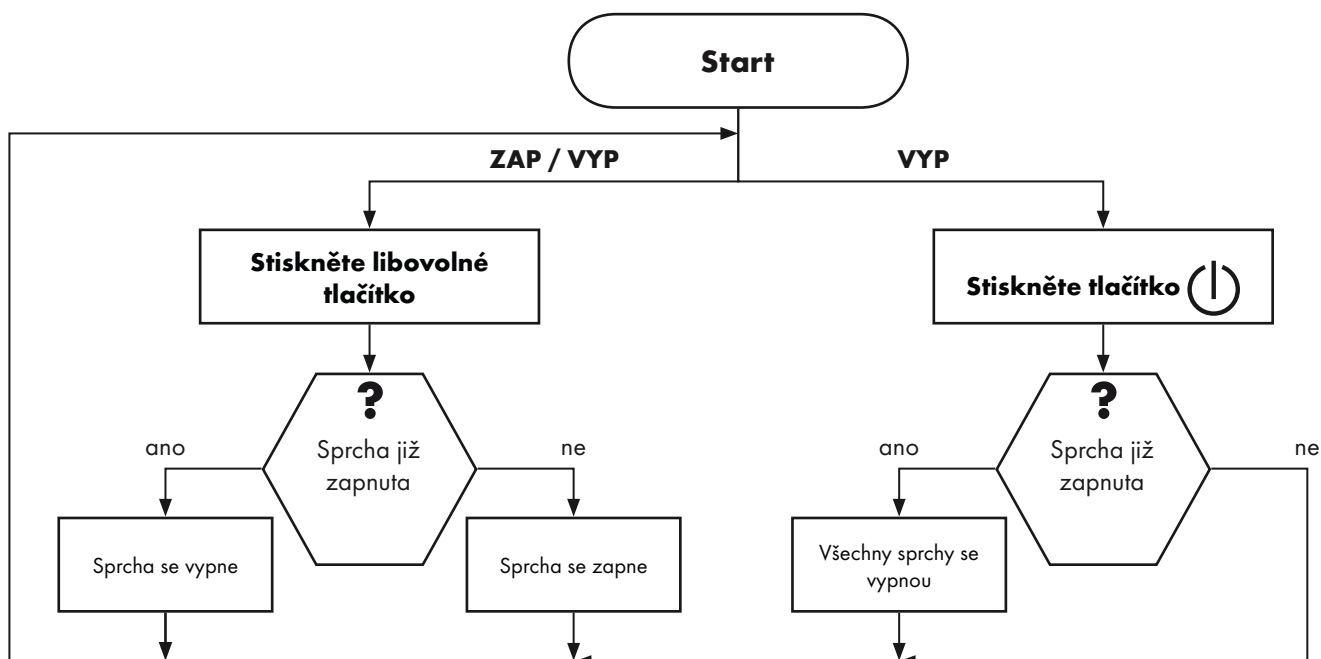

Česky Úroveň obsluhy

Raindance Rainfall
28411000

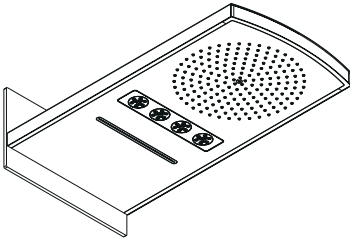

Provozní režim

Upozornění:
Všechny sprchy musí být vypnuty



Servisní mazání
Upozornění:
Světlo / kódovaný konektor 4 x zabliká

Upozornění:
Světlo / kódovaný konektor zhasne

Upozornění:
Světlo / kódovaný konektor 2 x zabliká

< 15 sek.

> 15 sek.

Stiskněte dvakrát rychle za sebou tlačítko  **nebo** 

Stiskněte dvakrát rychle za sebou tlačítko 

Režim maximální doby provozu
Upozornění:
Světlo / kódovaný konektor bliká v 1 sekundovém intervalu

Režim sprchy
Upozornění:
Světlo / kódovaný konektor bliká v 2 sekundovém intervalu

< 15 sek.

> 15 sek.

< 15 sek.

> 15 sek.

Stiskněte tlačítko  nebo 	Stiskněte tlačítko 	Stiskněte tlačítko 	Stiskněte tlačítko 
---	--	--	--

Stiskněte tlačítko  nebo 	Stiskněte tlačítko 
---	--

Doby provozu: Sprchy: 30 s Světlo: 30 min	Standard: Doby provozu: Sprchy: 60 s Světlo: 30 min	Doby provozu: Sprchy: 180 s Světlo: 30 min	Doby provozu: Sprchy + světlo: nekonečně
--	--	---	--

Standard mohou být zapnuty max. 2 sprchy	Komfort 1: současně mohou být zapnuty všechny sprchy
--	--

Česky Úroveň obsluhy

Raindance Rainmaker
28403000 / 28404000

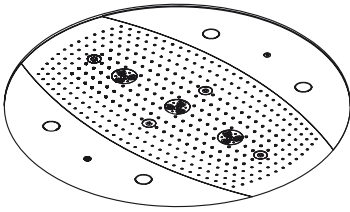

Provozní režim

Upozornění:
Všechny sprchy musí být vypnuty



Servisní mazání

Upozornění:
Světlo / kódovaný konektor 4 x zabliká

Upozornění:
Světlo / kódovaný konektor zhasne

Upozornění:
Světlo / kódovaný konektor 2 x zabliká

< 15 sek.

> 15 sek.

Stiskněte dvakrát rychle za sebou tlačítko nebo

Stiskněte dvakrát rychle za sebou tlačítko

Režim maximální doby provozu

Upozornění:
Světlo / kódovaný konektor bliká v 1 sekundovém intervalu

Režim sprchy

Upozornění:
Světlo / kódovaný konektor bliká v 2 sekundovém intervalu

< 15 sek.

> 15 sek.

< 15 sek.

> 15 sek.

Stiskněte tlačítko nebo

Stiskněte tlačítko

Stiskněte tlačítko

Stiskněte tlačítko

Stiskněte tlačítko nebo

Stiskněte tlačítko

Stiskněte tlačítko

Doby provozu:
Sprchy: 30 s
Světlo: 30 min

Standard:
Doby provozu:
Sprchy: 60 s
Světlo: 30 min

Doby provozu:
Sprchy: 180 s
Světlo: 30 min

Doby provozu:
Sprchy + světlo: nekonečně

Standard mohou být zapnuty max. 2 sprchy

Komfort 1:
současně mohou být zapnuty všechny sprchy

Komfort 2:
Větší množství vody je nutné pouze pro simulátor deště

Česky Úroveň expertů

Raindance Rainfall
28411000

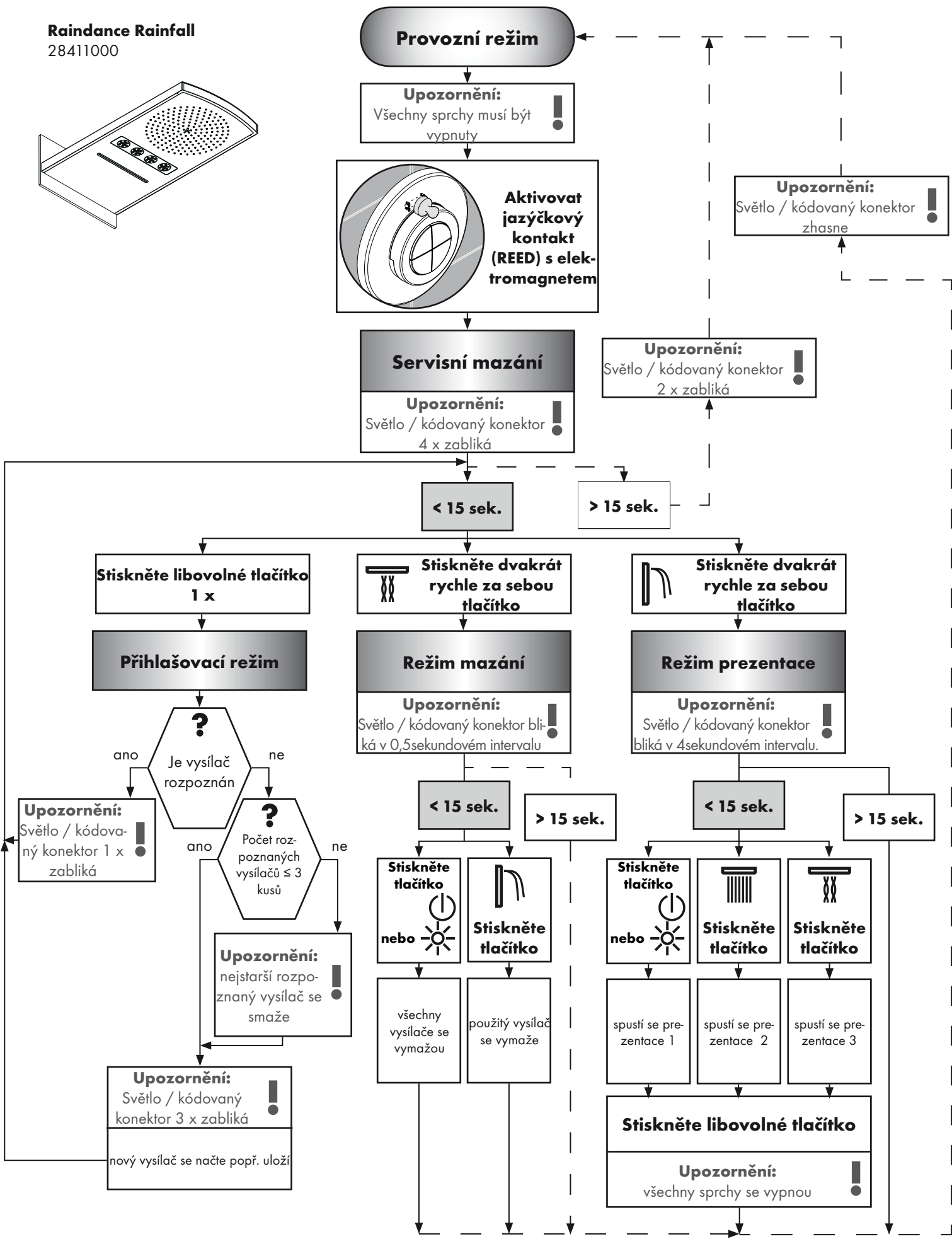
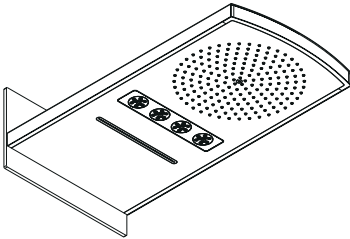

Česky Úroveň expertů

Raindance Rainmaker
28403000 / 28404000

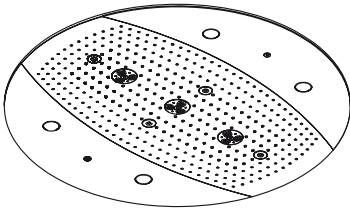

Provozní režim

Upozornění:
Všechny sprchy musí být vypnuty



Servisní mazání
Upozornění:
Světlo / kódovaný konektor 4 x zabliká

Upozornění:
Světlo / kódovaný konektor 2 x zabliká

Upozornění:
Světlo / kódovaný konektor zhasne

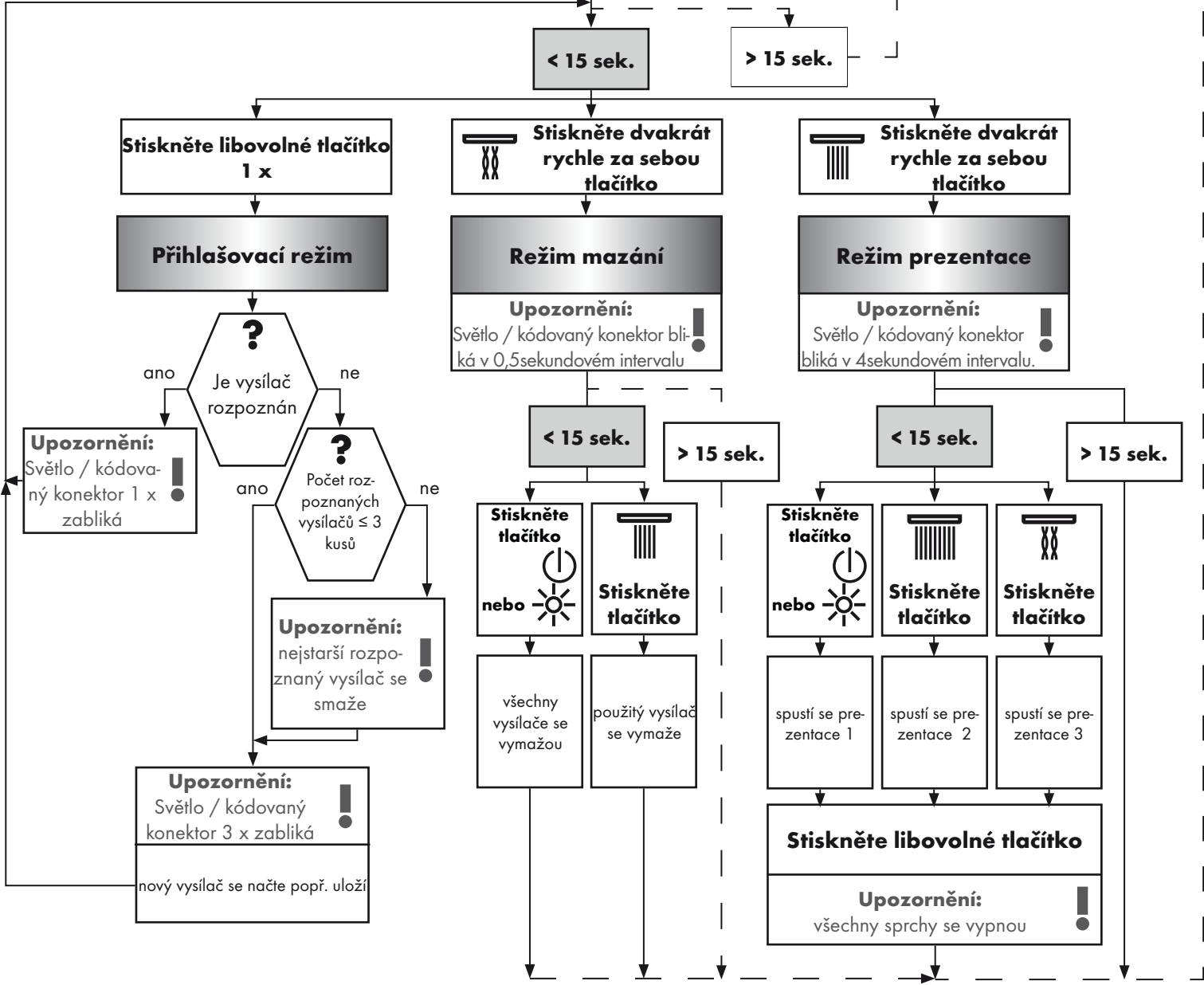

Normy a smernice:

Použitie výrobku je zaručené nasledovnými smernicami:

- EN 15200
- EN 60335-2-105



Bezpečnostné pokyny:

- Produkt sa smie používať len na kúpanie a telesnú hygienu.
- Deti nesmú používať sprchovací systém bez dozoru.
- Sprchovací systém nesmú bez dozoru používať deti, ako aj dospelé osoby s telesným, duševným a/alebo zmyslovým postihnutím. Sprchovací systém nesmú používať ani osoby, ktoré sú pod vplyvom alkoholu alebo drog.
- Vyhýbajte sa kontaktu vodného lúča sprchy s citlivými miestami tela (napr. oči). Dodržiavajte dostatočnú vzdialenosť medzi sprchou a telom.
- Veľké rozdiely v tlaku medzi prípojkami studenej a teplej vody musia byť vyrovnané.



Elektrické pripojenie:

- Inštalácie a skúšobné práce musí vykonávať len autorizovaný elektrikár pri zohľadnení noriem VDE 0100, časť 701 a IEC 60364-7-701.
- Pre elektrické pripojenie je potrebná iba jedna elektrická zásuvka. Zásobovanie elektrickým prúdom je zaistené pomocou externého transformátora.
- V bezprostrednej blízkosti sa nesmú nachádzať žiadne ľahko horľavé materiály.
- Okolité teplota nesmie byť vyššia ako 50 °C.
- Celkové zásobovanie elektrickým prúdom prebieha prostredníctvom pripojenia striedavého prúdu 230 V/N/PE/50 Hz
- Prívod musí byť chránený prúdovým chráničom (RCD/FI) pre chybový prúd s merným rozdielovým prúdom ≤ 30 mA.
- Ak je potrebné vyrovnať napätie, musí to vykonať stavebná firma.
- Pri elektroinštalácii je nutné dodržiavať príslušné predpisy VDE, krajiny a EVU v príslušnom platnom vydaní.
- Je nutné zabezpečiť, aby sa výrobok dal odpojiť od siete. Buď voľne prístupnou zástrčkou alebo viacpólovým vypínačom podľa smernice EN 60335-1 odstavce 24.3.



Montáž: (viď strana 303)

- Pozor! Armatúra sa musí montovať, preplachovať a testovať podľa platných noriem. (Inštalácia podľa DIN 1717) Pozrite si návod na montáž: Raindance Rainfall 28411000 Raindance Rainmaker 28403000 / 28404000 / 28417000 / 28418000
- Všetky práce sa smú vykonávať len vtedy, keď je prístroj odpojený od elektrického napätia.
- Základné teleso 15941180 je možné zabudovať len zvislo! Montáž s regulačným krúžkom (A) je možná len v prednej a strednej oblasti!
- Všetky komponenty musia zostať prístupné.

Technické údaje:

Prevádzkový tlak:	max. 1 MPa
Doporučený prevádzkový tlak:	0,1 - 0,5 MPa
Skúšobný tlak:	1,6 MPa
(1 MPa = 10 bar = 147 PSI)	
Teplota teplej vody:	max. 80 °C
Doporučená teplota teplej vody:	65 °C
Prípájacie rozmery:	G 3/4
Prípoje Vstup:	Dávkovaná voda do miešačky
Volný prietok pri 0,3 MPa	
1 Spotrebič:	35 l/min
2 Spotrebič:	45 l/min



Príslušenstvo: (viď strana 104)



Rozmery: (viď strana 292)



Príklady montáže Raindance Rainfall: (viď strana 295)



Príklady montáže Raindance Rainmaker: (viď strana 299)



Obsluha: (viď strana 106)

- Pri výpadku sieťového napätia 230 V nie je možné uviesť sprchovacie zariadenie do prevádzky.
- Výrobok nie je vhodný na použitie v spojení s parným kúpeľom!



Čištění Filtrační sítka: (viď strana 309)





























Náhradné diely (viď strana 311)

Montáž viď strana 303

Slovensky Technické informácie

Porucha	Príčina	Pomoc
Žiadna funkcia	<ul style="list-style-type: none"> - Žiadne elektrické napájanie - Trafo základnej súpravy je defektné - Prijímač je nesprávne uložený / defektný - Vysielač nie je naprogramovaný / je defektný 	<ul style="list-style-type: none"> - Zabezpečiť napájanie elektrickým prúdom - Vymeniť trafo - Zmeniť polohu prijímača resp. prijímač vymeniť - Vysielač naprogramovať / vymeniť
Prevádzkový režim nie je možné konfigurovať	<ul style="list-style-type: none"> - Jazyčkový kontakt nie je v správnej polohe za rozetou - Jazyčkový kontakt chybný 	<ul style="list-style-type: none"> - Umiesť jazyčkový kontakt na ružicu - Vymeniť magnetický ventil na prípojnom vedení
Žiadna funkcia svetidla	<ul style="list-style-type: none"> - Trafo Rainmaker nie je pripojené / je defektné - Prívody relé svetidla sú chybné / defektné 	<ul style="list-style-type: none"> - Zabezpečiť napájanie trafo elektrickým prúdom / vymeniť trafo - Preskúšať / vymeniť spoje a relé svetidla
Spotrebiče sa automaticky zastavia	<ul style="list-style-type: none"> - Čas prevádzky je uložený v režime programu 	<ul style="list-style-type: none"> - Predĺžiť / vypnúť dobu dokvap v servisnom režime
Armatúra je netesná	<ul style="list-style-type: none"> - Magnetický ventil znečistený / defektný 	<ul style="list-style-type: none"> - Očistiť / vymeniť membránu magnetického ventilu
Príliš malé množstvo prietoku	<ul style="list-style-type: none"> - Sito na zachytenie nečistôt na vstupnej strane je znečistené 	<ul style="list-style-type: none"> - Vyčistiť alebo vymeniť filter

Symboly

	Pripojenie vody DN 20 Teplá voda		transformátor		Vyrovnanie potenciálov
	Pripojenie vody DN 20 Studená voda		Prijímač		všetko vyp.
	Zapojiť vodu		Kódovaný konektor		Svetlo
	Odpojiť vodu		230V		Rain
	Od • je zaručená funkcia.		12V		Whirl
	Výkon odtoku musí byť vyšší ako 50 l/min.		Ochranná rúra EN20		Rainflow
	Odtok		Riadenie osvetlenia 27189000 (nie je súčasťou dodávky)		Rain AIR XXL
	Raindrain		Svetelné relé Rainmaker		Rain AIR
	Stred sprchovej vane		transformátor Rainmaker		Silikon (bez kyseliny octovej!)
			Vopred nainštalovaná 12 V prípojka pre svetidlo (max. 80 W) zo strany stavby		

Montáž vid' strana 303

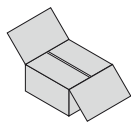

Slovensky Príslušenstvo

Transformátor:

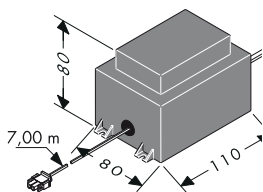

Výkon externého transformátora je 50 VA. Transformátor sa musí nainštalovať v suchom priestore (zóna ochrany 3). Transformátor môžete spolu s prijímačom zabudovať do plastového puzdra pri zohľadnení normy EN/IEC 60335-1. (rozmery cca 250 x 160 x 92 mm, nie je súčasťou dodávky.) Spoludodaný kábel umožňuje inštaláciu transformátora vo vzdialenosti až 7,00 m od prijímača. K tomu musíte pripraviť prázdnu ochrannú trubku EN35 (nie je súčasťou dodávky). Ochranná trubka musí byť upevnená minimálne každých 500 mm a polomer ohnutia musí byť väčší ako 100 mm. Približne 7,00 m dlhé sekundárne vedenie transformátora nesmiete skracovať. Nepotrebnú dĺžku vedenia by ste mali uložiť v blízkosti bezpečnostného

transformátora. Poškodené pripojovacie vedenie nesmiete vymieňať. Transformátor potom nemôžete ďalej prevádzkovať.

Poškodené pripojovacie vedenie nesmiete vymieňať. Pri defektnom pripojovacom sieťovom vedení musí byť vedenie vrátane traťa vymenené odborníkom v oblasti elektrotechniky.

Svetelné relé:

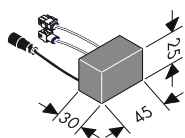

(len pri variantoch s integrovaným svetidlom)
Svetelné relé môžete zaťažiť maximálne 12 V AC/80 W.
Prevádzka v 230 V sieti nie je prípustná.

Riadenie osvetlenia:

27189000

(nie je súčasťou dodávky)

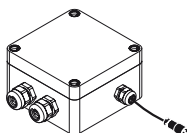

(iControl mobile 15944000)
Ovládanie osvetlenia musí byť u variantov s externým svetelným zdrojom pripojené. Ovládanie osvetlenia musí byť vždy prístupné.

Kódovaný konektor:

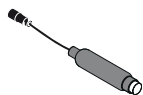

(Raindance Rainfall 28411000 / Raindance Rainmaker 28403000)
Kódovaný konektor musí byť pripojený u variant bez svetla.
Keď je aktivovaný servisný režim u variant bez svetla, zobrazuje svetelná dióda kódovaného konektora optické spätné hlásenia.
Kódovaný konektor musí byť vždy prístupný.

Pripojovacie vedenie Magnetický ventilový blok / Pripojovacie vedenie Svetlo:



7,50 m dlhé vedenie magnetického ventilového bloku, ako aj 10,00 m dlhé svetelné vedenie, nesmiete skracovať. Nepotrebnú dĺžku vedenia by ste mali uložiť v blízkosti prijímača.

Vedenie magnetického ventilového bloku a svetelné vedenie sa smie uložiť len do spoludodanej ochrannej trubky (EN 20).

Ochranná trubka musí byť upevnená minimálne každých 500 mm a polomer ohnutia musí byť väčší ako 100 mm.

Pozor: Do ochranných trubiek pre vedenie magnetického ventilového bloku a svetelné vedenie sa nesmú ukladať žiadne elektrické vedenia, ktoré vedú napätie väčšie ako 12 V.

Montáž vid' strana 303

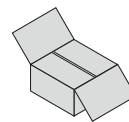

Prijímač:

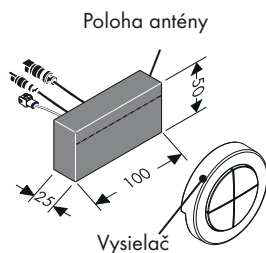

Prijímač by sa prednostne mal namontovať do rovnakej miestnosti ako sprchovacie zariadenie.

Ak to nie je možné, môže sa prijímač namontovať aj do miestnosti, ktorá susedí s miestnosťou so sprchovacím zariadením.

Prijímač sa nesmie montovať do kovového puzdra, pretože by sa odtienili rádiové signály vysielača. Ďalej treba dbať na to, aby sa v blízkosti miesta osadenia prijímača nachádzalo čo najmenej tieniacich kovových častí.

Pre optimálne rozpoznanie rádiových signálov

by mala byť anténa prijímača naklonená k vysielaču.

Vysielač:



Pri dodaní je vysielač už spárovaný s prijímačom. Vďaka identickým sériovým číslam je možné vysielač priradiť k prijímaču.

Ďalšie príp. dodatočne získané vysielače sa musia spárovať s prijímačom. Spárovať príp. uložiť je možné maximálne štyri vysielače. (viď strana 110/111 Prihlasovací režim).

Rádiová frekvencia vysielača je 868,3 MHz.

Upozornenie: Správny postup pri výmene chybného vysielača za nový vysielač:

1. Vymazať všetky vysielače. (Prihlasovací režim ⇒ Režim mazania).
2. Všetky vysielače, okrem chybného vysielača, spárovať znova. (Režim servisná ⇒ Prihlasovací režim).

Upozornenie: Prijímač a vysielač majú dosah cca 10,00 m. Dosah závisí od toho, ako silno sú utlmené rádiové signály medzi vysielačom a prijímačom.

Upozornenie: Z bezpečnostných dôvodov používajte vysielač len v okruhu viditeľnosti sprchovacieho systému. V opačnom prípade môže dôjsť k neúmyselnému spusteniu vody.

Materiál	Utlmenie
Drevo, sadra, sklo (bez povrchovej úpravy, bez kovových častí)	0 - 10 %
Tehla, lisované drevotrieskové dosky	5 - 35 %
Betón s armovaním zo železa	10 - 90 %
Kov, hliníkové opláštenie	90 - 100 %

Magnet:



Pre aktiváciu servisného režimu musí magnet aktivovať kontakt REED (za rozetou). (viď strana 108/109, Režim servisná).

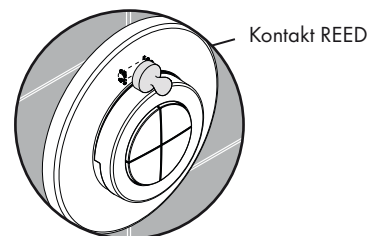

Raindance Rainfall

28411000

iControl mobile

15940180 / 15942000

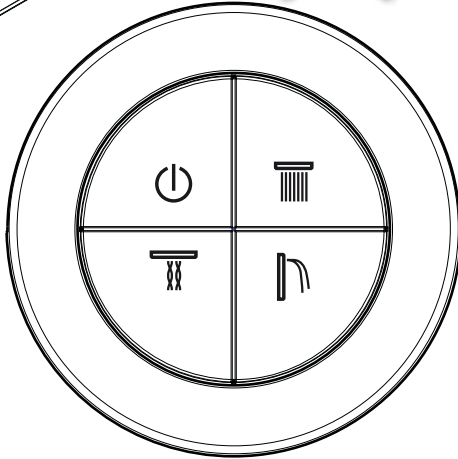
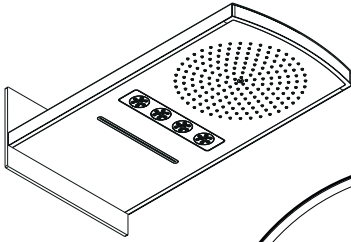

Raindance Rainfall

28411000

iControl mobile

15941180 / 15944000

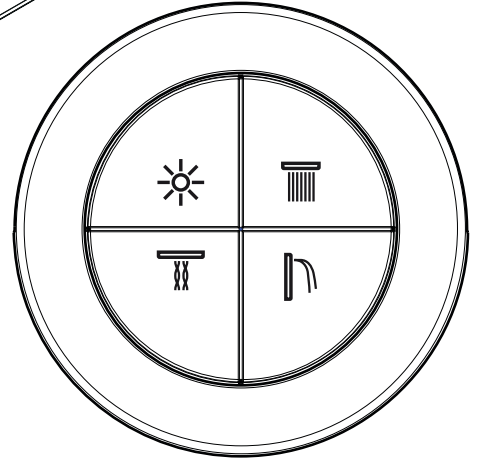
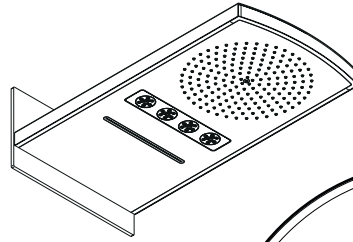

Raindance Rainmaker

28403000

iControl mobile

15940180 / 15943000

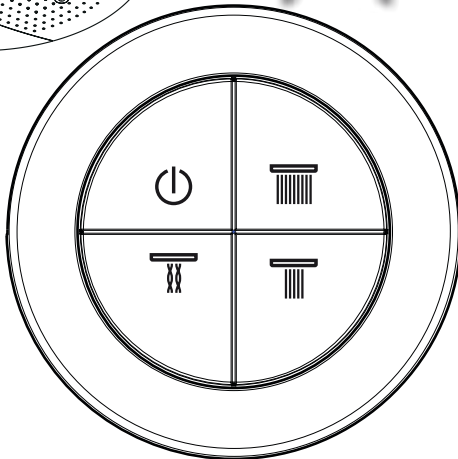
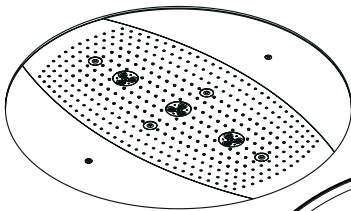

Raindance Rainmaker

28404000

iControl mobile

15941180 / 15945000

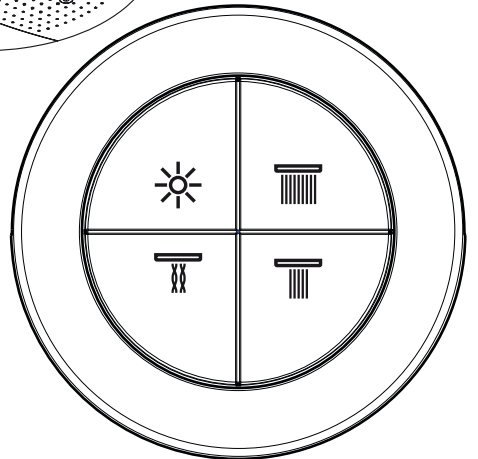
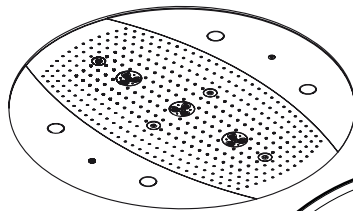

všetko vyp.



Rain



Whirl



Rainflow



Svetlo



Rain AIR XXL



Rain AIR

Montáž vid' strana 303

Zapnutie a vypnutie sprchy a svetla:

(Štandardná funkcia so svetlom)

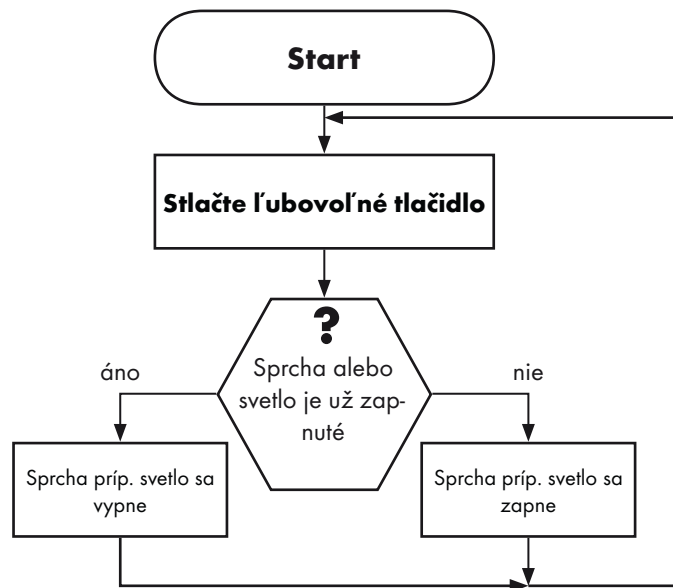

Zapnutie a vypnutie sprchy:

(Štandardná funkcia bez svetla)

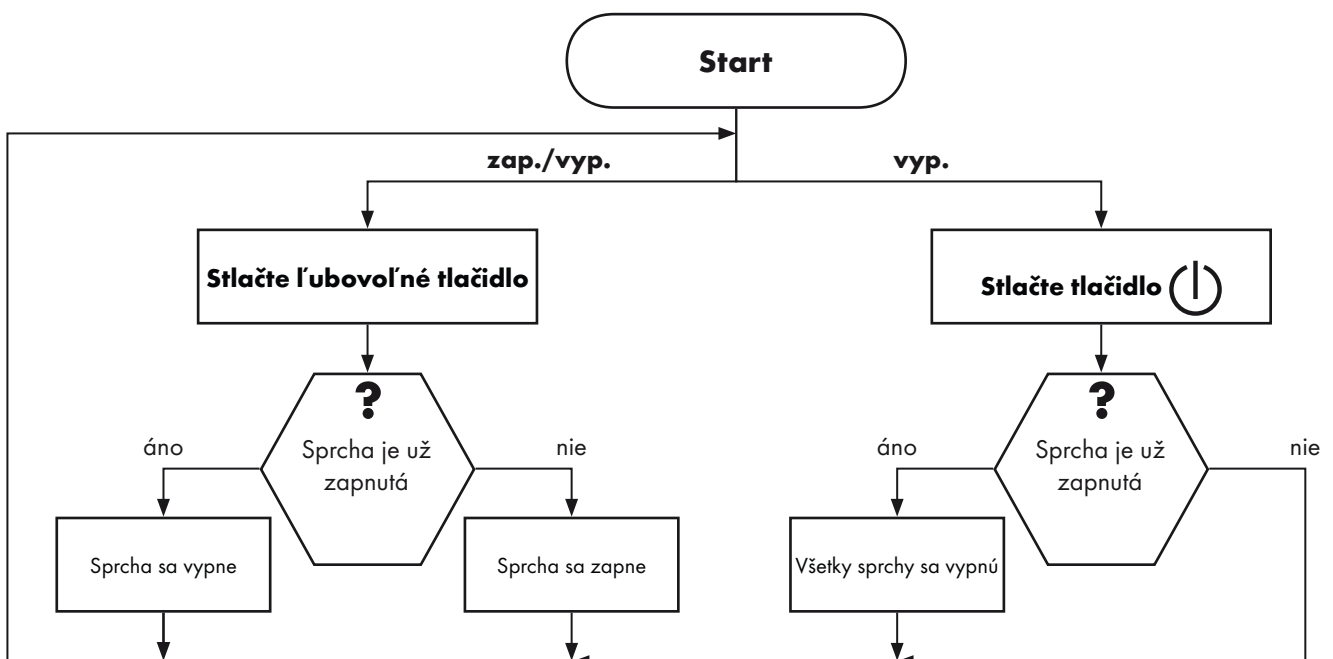

Slovensky

Úroveň obsluhy

Raindance Rainfall
28411000

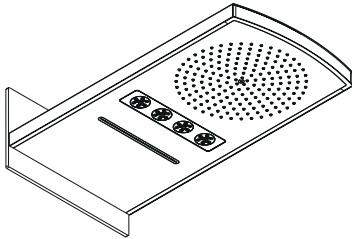

Prevádzkový režim

Upozornenie:
Všetky sprchy musia byť vypnuté



Upozornenie:
Svetlo/kódovaný konektor zhasne

Režim servisná

Upozornenie:
Svetlo/kódovaný konektor 4 x zabliká

Upozornenie:
Svetlo/kódovaný konektor 2 x zabliká

< 15 sek.

> 15 sek.

Dvakrát stlačte tlačidlo



Režim maximálnej doby chodu

Upozornenie:
Svetlo/kódovaný konektor bliká v 1 sek. Intervaloch

Dvakrát stlačte tlačidlo

Režim sprchovania

Upozornenie:
Svetlo/kódovaný konektor bliká v 2 sek. Intervaloch

< 15 sek.

> 15 sek.

< 15 sek.

> 15 sek.

Stlačte tlačidlo
alebo

Stlačte tlačidlo

Stlačte tlačidlo

Stlačte tlačidlo

Doby chodu:
Sprchy: 30 s
Svetlo: 30 min

Štandard:
Doby chodu:
Sprchy: 60 s
Svetlo: 30 min

Doby chodu:
Sprchy: 180 s
Svetlo: 30 min

Doby chodu:
Sprchy + svetlo:
nekonečno

Stlačte tlačidlo
alebo

Stlačte tlačidlo

Štandard
môžu sa zapnúť max. 2 sprchy

Komfort 1:
všetky sprchy sa môžu zapnúť súčasne

Slovensky

Úroveň obsluhy

Raindance Rainmaker
28403000 / 28404000

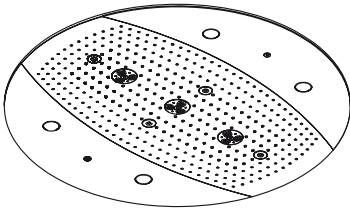

Prevádzkový režim

Upozornenie:
Všetky sprchy musia byť vypnuté



Režim servisná

Upozornenie:
Svetlo/kódovaný konektor 4 x zabliká

Upozornenie:
Svetlo/kódovaný konektor zhasne

Upozornenie:
Svetlo/kódovaný konektor 2 x zabliká

< 15 sek.

> 15 sek.

Dvakrát stlačte tlačidlo
alebo

Dvakrát stlačte tlačidlo

Režim maximálnej doby chodu

Režim sprchovania

Upozornenie:
Svetlo/kódovaný konektor bliká v 1 sek. Intervaloch

Upozornenie:
Svetlo/kódovaný konektor bliká v 2 sek. Intervaloch

< 15 sek.

> 15 sek.

< 15 sek.

> 15 sek.



Doby chodu:
Sprchy: 30 s
Svetlo: 30 min

Štandard:
Doby chodu:
Sprchy: 60 s
Svetlo: 30 min

Doby chodu:
Sprchy: 180 s
Svetlo: 30 min

Doby chodu:
Sprchy + svetlo:
nekonečno

Štandard
môžu sa zapnúť max. 2 sprchy

Komfort 1:
všetky sprchy sa môžu zapnúť súčasne

Komfort 2:
Väčšie množstvo vody, potrebné len pri zariadení Rainmaker (simulácia dažďa)

Slovensky

Úroveň expertov

Raindance Rainfall
28411000

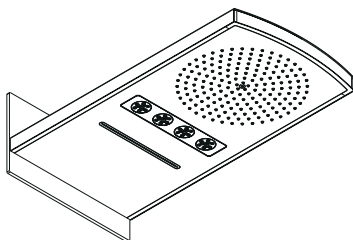

Prevádzkový režim

Upozornenie:
Všetky sprchy musia byť vypnuté



Režim servisná

Upozornenie:
Svetlo/kódovaný konektor 4x zabliká

Upozornenie:
Svetlo/kódovaný konektor zhasne

Upozornenie:
Svetlo/kódovaný konektor 2 x zabliká

< 15 sek.

> 15 sek.

1 x stlačte ľubovoľné tlačidlo

Dvakrát stlačte tlačidlo

Dvakrát stlačte tlačidlo

Prihlasovací režim

Režim mazania

Režim prezentácie

Upozornenie:
Svetlo/kódovaný konektor bliká v 0,5 sek. Intervaloch

Upozornenie:
Svetlo/kódovaný konektor bliká v 4 sek. Intervaloch

Je vysieláč známy?

áno

nie

Upozornenie:
Svetlo/kódovaný konektor 1 x zabliká

Počet známych vysieláčov ≤ 3 kusov

áno

nie

Upozornenie:
najstarší známy vysieláč sa vymaže

Upozornenie:
Svetlo/kódovaný konektor 3 x zabliká

nový vysieláč sa spáruje príp. uloží

< 15 sek.

> 15 sek.

< 15 sek.

> 15 sek.

Stlačte tlačidlo

všetky vysieláče sa vymažú

Stlačte tlačidlo

vymaže sa používaný vysieláč

Stlačte tlačidlo

Spustí sa prezentácia 1

Stlačte tlačidlo

Spustí sa prezentácia 2

Stlačte tlačidlo

Spustí sa prezentácia 3

Stlačte ľubovoľné tlačidlo

Upozornenie:
všetky sprchy sa vypnú

Slovensky Úroveň expertov

Raindance Rainmaker
28403000 / 28404000

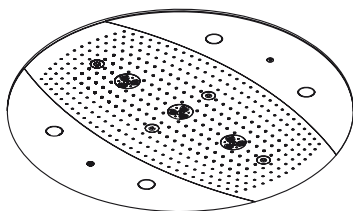

Prevádzkový režim

Upozornenie:
Všetky sprchy musia byť vypnuté



Aktivujte jazyčkový kontakt s magnetom

Režim servisná

Upozornenie:
Svetlo/kódovaný konektor 4x zabliká

Upozornenie:
Svetlo/kódovaný konektor zhasne

Upozornenie:
Svetlo/kódovaný konektor 2 x zabliká

< 15 sek.

> 15 sek.

1 x stlačte ľubovoľné tlačidlo

Dvakrát stlačte tlačidlo

Dvakrát stlačte tlačidlo

Prihlasovací režim

Režim mazania

Režim prezentácie

Upozornenie:
Svetlo/kódovaný konektor bliká v 0,5 sek. Intervaloch

Upozornenie:
Svetlo/kódovaný konektor bliká v 4 sek. Intervaloch

Je vysieláč známy?

áno

nie

Upozornenie:
Svetlo/kódovaný konektor 1 x zabliká

Počet známych vysieláčov ≤ 3 kusov

áno

nie

Upozornenie:
najstarší známy vysieláč sa vymaže

Upozornenie:
Svetlo/kódovaný konektor 3 x zabliká

nový vysieláč sa spáruje príp. uloží

< 15 sek.

> 15 sek.

< 15 sek.

> 15 sek.

Stlačte tlačidlo

všetky vysieláče sa vymažú

Stlačte tlačidlo

vymaže sa používaný vysieláč

Stlačte tlačidlo

Spustí sa prezentácia 1

Stlačte tlačidlo

Spustí sa prezentácia 2

Stlačte tlačidlo

Spustí sa prezentácia 3

Stlačte ľubovoľné tlačidlo

Upozornenie:
všetky sprchy sa vypnú

标准和准则:

本产品的功能通过下列准则得到保障:

- EN 15200
- EN 60335-2-105



安全技巧:

- 淋浴系统只允许作为洗浴、卫生和洁身之用。
- 若无人照看，儿童不得使用本淋浴系统。
- 不得让儿童和肢体、精神和/或意识有障碍的成人在不受监管的情况下使用淋浴系统。受酒精或毒品影响的人员不得使用淋浴系统。
- 必须避免让身体敏感部位（如眼睛）接触到莲蓬头喷水。必须保持莲蓬头与人头之间有足够的距离。
- 冷热水管间过大的压力差必须予以平衡。



电气连接:

- 安装和检查工作由有资质的电气专业人员按照德国电气工程协会VDE 0100标准中第701项和国际电工委员会IEC 60364-7-701标准执行。
- 电线接口只需一个插孔。电源通过一个外接变压器提供。
- 在直接接触的地点附近不能存有易燃材料。
- 环境温度不得超过50 °C。
- 总电源供应通过一个230V/N/PE/50HZ的交流电源接口实现。
- 保险装置必须是额定电流 ≤ 30 mA的故障电流保护装置。
- 如果必须有电位抵消，那么，这可以当场完成。
- 在进行电力安装的过程中，遵守有效的德国电工规范以及本国的电力危险防护规定。
- 必须确保本产品可以从电源上断开。根据EN 60335-1 Abs. 24.3 的规定，要么通过一个独立的附加插头，要么通过一个全极开关。



安装: (参见第页 303)

- 注意！必须按照现行的规定安装，冲洗和测试产品。(按照EN 1717进行安装) 参见安装说明:
Raindance Rainfall 28411000
Raindance Rainmaker 28403000 / 28404000 / 28417000 / 28418000
- 所有的工作只能在没有电压的状况下进行。
- 基体15941180必须垂直装入。只有前面和中间区域才能安装调整环！
- 所有组件必须保持可供使用。

技术参数:

工作压强: :	最大 1 MPa
推荐工作压强:	0,1 - 0,5 MPa
测试压强: :	1,6 MPa
(1 MPa = 10 bar = 147 PSI)	
热水温度: :	最大 80° C
推荐热水温度:	65° C
中心距离:	G 3/4
连接管线 入口:	混合水
0,3 MPa时的流速:	
1 用户:	35 升/分钟
2 用户:	45 升/分钟



附件: (参见第页 114)



大小: (参见第页 292)



安装示意 Raindance Rainfall: (参见第页 295)



安装示意 Raindance Rainmaker: (参见第页 299)



操作: (参见第页 116)

- 电压不足230伏不能使用本淋浴装置
- 本产品并非设计来与蒸气浴连接使用！



清洗 过滤网: (参见第页 309)

备件 (参见第页 311)

中文 技术数据

问题	原因	补救
丝毫没有作用	- 无电源供给 - 底部的变压器损坏 - 接收器处于不适当的位置/损坏 - 发射器没有记住/损坏	- 确保电源供给 - 更换变压器 - 接收器位置改变或者更换接收器 - 发射器记住/更换
运行模式无法配置	- 簧片触点未处于接线盒后适当的位置 - 簧片触点错误	- 簧片触点放置在接线盒上 - 更换电磁阀连接导线
没有照明功能	- 人工降雨设备 (Rainmaker) 变压器未插入/错误 - 照明继电器馈电线欠缺/损坏	- 确保变压器电压馈电 / 更换变压器 - 检查/更换连接和照明继电器
用户自己安排	- 使用时间保存在程序模式里	- 延长/停止服务模式的跟踪时间
阀门渗漏	- 电磁阀堵塞/漏水	- 清洁/更换电磁阀膜片
流量太小	- 入口侧过滤网脏污	- 清洁过滤网/更换过滤网

标志



安装 参见第页 303

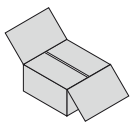

附件

变压器:

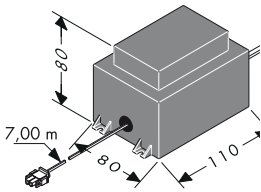

外接变压器的功率是50VA 必须在干燥的区域内（保护区域3）安装变压器。变压器可以和一个接受器一起按照EN/IEC 60335-1标准装入一个塑料外壳里。（尺寸250 x 160 x 92 mm, 不属于提供范围, 即包装里不附带, 需另外购买。）附带的电线长度可以满足变压器与接收器之间7米远的安装距离。为此必须准备一个EN35空管（不属于提供范围, 即包装里不附带, 需另外购买）。这个空管必须确定至少是500毫米, 其弯曲半径必须大于100毫米。

变压器的大概7米长的二级管不能再缩短了。不需要的电线长度应放置到安全变压器旁边。受损的电线不允许被替换。那么, 变压器不能再使用。

受损的电线不允许被替换。当电源连接线损坏时必须由电工对电源线包括变压器进行更换。

光继电器:

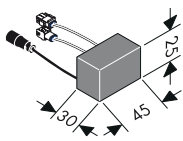

（仅适用于集成光模式）
该光继电器可以负荷12伏交流电/80瓦。
不能在230伏的电网上使用。

光控系统:

27189000

(不在供货范围内)

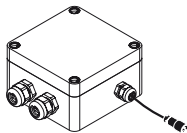

(iControl mobile 15944000
照明控制系统必须在外部光源改变时接通。
照明控制系统必须随时可供使用。

编码销:

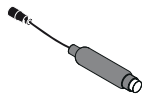

(Raindance Rainfall 28411000 /
Raindance Rainmaker 28403000)
在改变（编码）时, 编码销必须在没有光线的时候接上。
如果服务模块在在没有光线的情况下改变（编码）时被激活, 这表示编码销的发光二极管的光学回馈。
编码插头必须随时可用。

连接线 电磁阀组 / 连接线 灯（或者光）:



电磁阀导线不能短于7.5米, 照明用电源线不可短于10米。不需要的电线长度应放置到接收器附近
电磁阀导线和照明用电源线只能放置在供给的空管(EN20)中。
这个空管必须确定至少是500毫米, 其弯曲半径必须大于100毫米。

注意: 放置电磁阀导线和照明用电源线的空管中不能放置电线, 电线会产生高于12伏的电压。

安装 参见第页 303

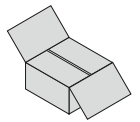

接收器:

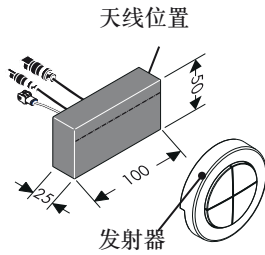

接收器应该尽量与淋浴装置安装在同一个房间。
如果不能在同一个房间，也可安装在淋浴接收器旁边的房间。
接收器不能装在金属外壳里面，因为这样发射器发出的无线信号会被屏蔽。另外，还须注意，接收器旁边尽量少放置有屏蔽效果的金属物件。
为了更好地识别无线信号，请尽可能把接收器的天线朝向发射器。

发射器:



出厂前发射器已经记在接收器上了。通过相同的序列号，发射器可以向接收器发射信号。
附加或后来购买的发射器必须记住到接收器。最多可以记住或者存储4个发射器 (参见第页 120/121 登陆模式)。
发射器的无线频率是868.3兆赫。

指示说明: 基于安全因素考虑，发射器仅在淋浴系统可见范围内使用。否则，它会不经意地打开水。

指示说明: 正确地用新的发射器替换旧的发射器。
1. 删除所有发射器 (登陆模式 删除模块)。
2. 所有发射器，除了有故障的，重新记住。(备用零模块 登陆模式)。

指示说明: 发射器和接收器之间的有效距离约10米。有效距离取决于发射器和接收器之间的无线信号的阻尼 (被削弱的) 强度。

材料	阻尼
木材、石膏、玻璃 (未被包覆, 没有金属)	0 - 10 %
砖、压制硬纸板	5 - 35 %
钢筋混凝土	10 - 90 %
金属、铝合金	90 - 100 %

磁铁:



为了激活服务模式，磁体必须操作舌状触点 (挡圈后面)。(参见第页 118/119, 备用零模块)。

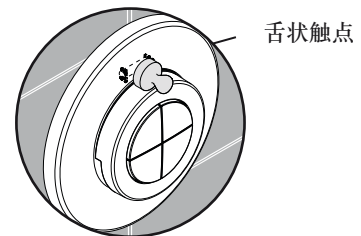

Raindance Rainfall

28411000

iControl mobile

15940180 / 15942000

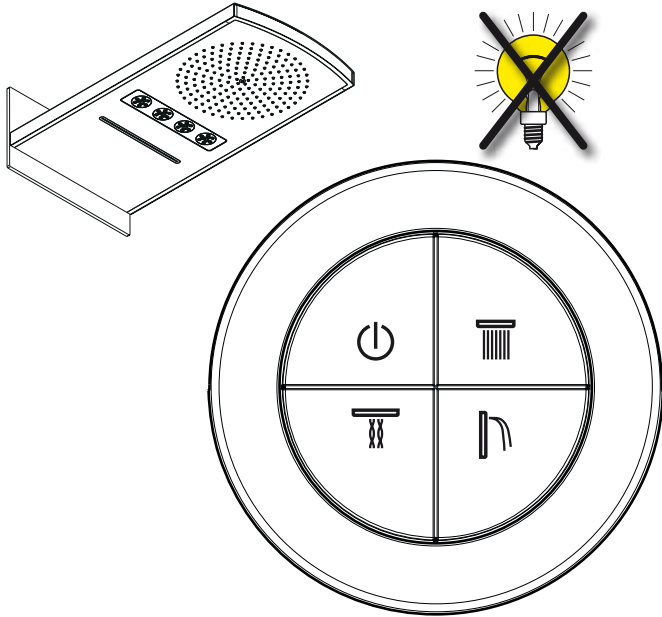

Raindance Rainfall

28411000

iControl mobile

15941180 / 15944000

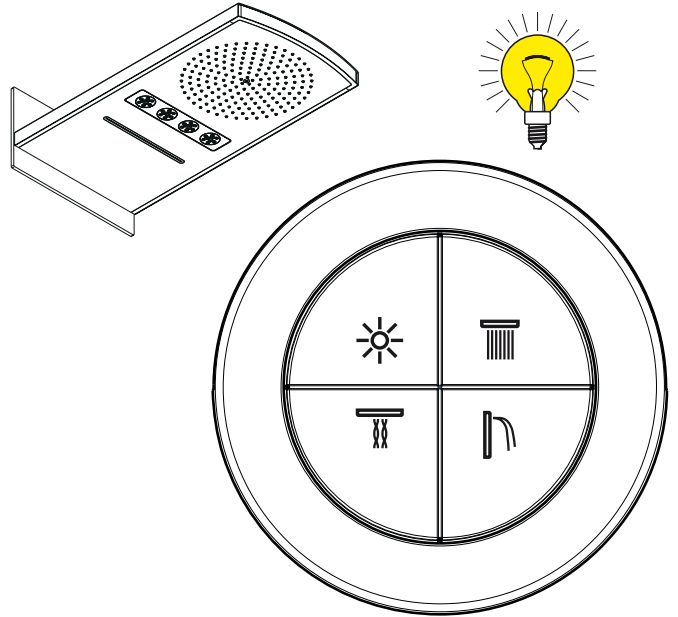

Raindance Rainmaker

28403000

iControl mobile

15940180 / 15943000

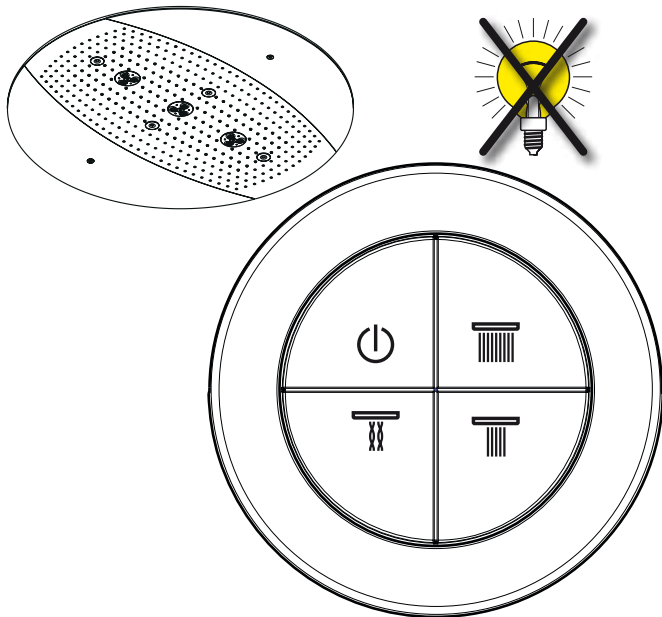

Raindance Rainmaker

28404000

iControl mobile

15941180 / 15945000

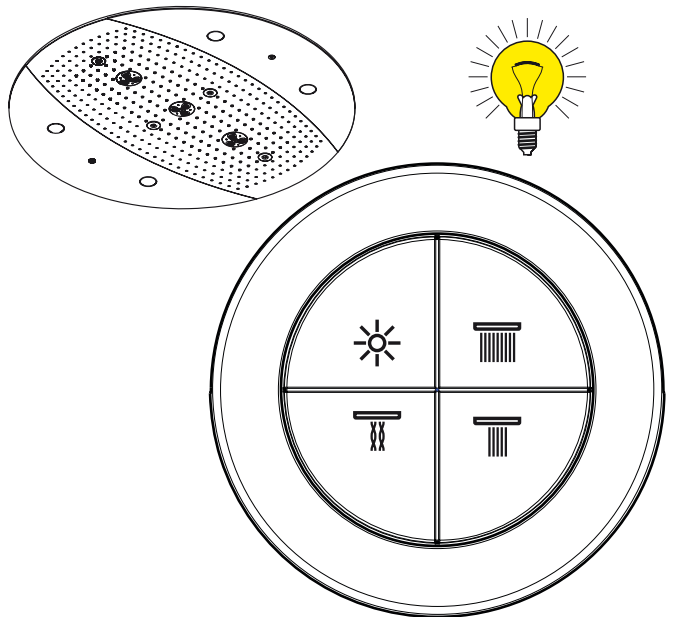

关闭所有的机器



Rain



Whirl



Rainflow



灯 (或者光)



Rain AIR XXL



Rain AIR

安装 参见第页 303

莲蓬头和灯的打开和关闭：
(有灯（光）时的标准功能)

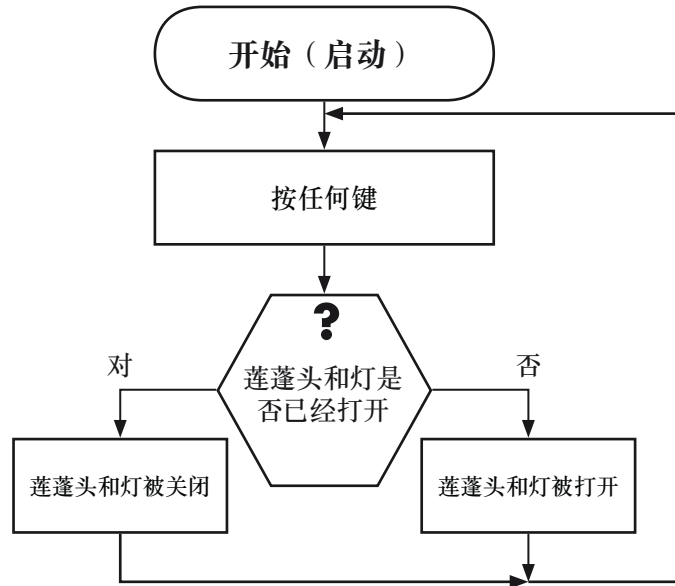

莲蓬头打开和关闭：
(无灯（光）的标准功能)

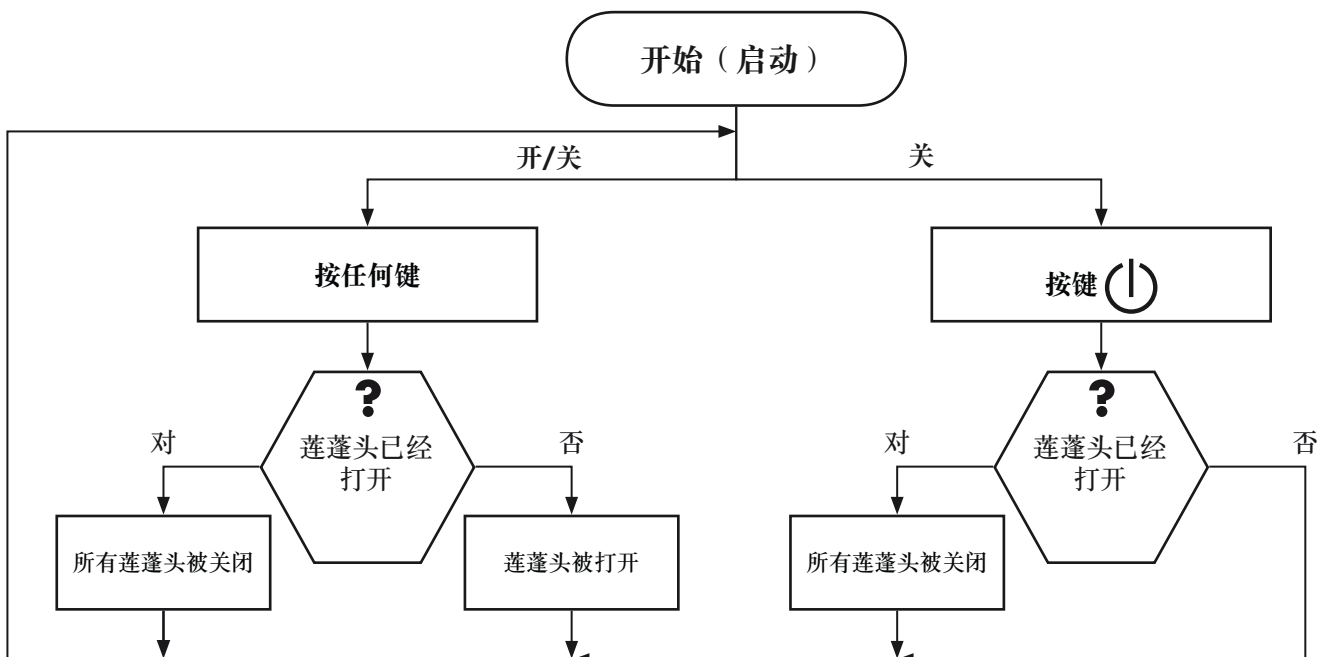

中文 操作人员界面

Raindance Rainfall
28411000

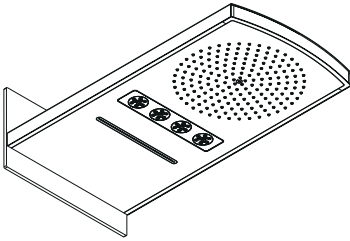

运作模块

指示说明：
所有莲蓬头必须关闭

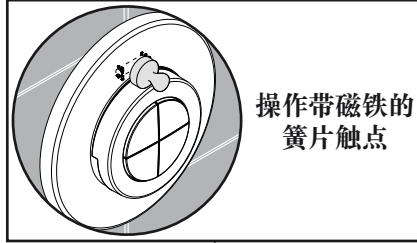

备用零模块

指示说明：
灯/编码销 闪4次

指示说明：
灯/编码销

指示说明：
灯/编码销 闪2次

< 15 秒

> 15 秒

双击 (⏻) 或 (☀️) 键

双击 (⏻) 键

最大运行时间模块

指示说明：
灯/编码销以1秒的节奏
闪动

莲蓬头模块

指示说明：
灯/编码销以2秒的节奏
闪动

< 15 秒

> 15 秒

< 15 秒

> 15 秒

按 (⏻) 或 (☀️) 键	(⏻) 键	(⏻) 键	(⏻) 键
----------------	-------	-------	-------

按 (☀️) 或 (⏻) 键	(⏻) 键
----------------	-------

运行时间： 莲蓬头: 30 s 灯 (或者光) : 30 min	标准： 运行时间： 莲蓬头: 60 s 灯 (或者光) : 30 min	运行时间： 莲蓬头: 180 s 灯 (或者光) : 30 min	运行时间： 莲蓬头+灯： 无止境地
---	--	--	-------------------------

标准 最多打开两个 莲蓬头	舒适 1: 所有莲蓬头可以 同时打开
---------------------	--------------------------

中文 操作人员界面

Raindance Rainmaker
28403000 / 28404000

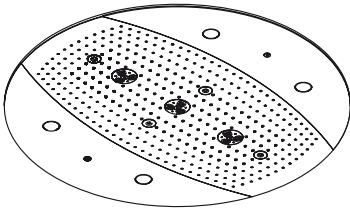

运作模块

指示说明：
所有莲蓬头必须关闭

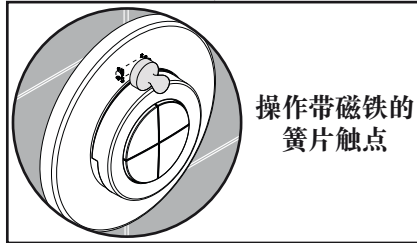

备用零模块

指示说明：
灯/编码销 闪4次

指示说明：
灯/编码销

指示说明：
灯/编码销 闪2次

< 15 秒

> 15 秒

双击 (⏻) 或 (☀️) 键

双击 (⏻) 键

最大运行时间模块

指示说明：
灯/编码销以1秒的节奏
闪动

莲蓬头模块

指示说明：
灯/编码销以2秒的节奏
闪动

< 15 秒

> 15 秒

< 15 秒

> 15 秒

按 (⏻) 或 (☀️) 键	按键 (⏻)	按键 (⏻)	按键 (⏻)
----------------	--------	--------	--------

按 (☀️) 或 (⏻) 键	按键 (⏻)	按键 (⏻)
----------------	--------	--------

运行时间： 莲蓬头: 30 s 灯 (或者光): 30 min	标准： 运行时间： 莲蓬头: 60 s 灯 (或者光): 30 min	运行时间: : 莲蓬头: 180 s 灯 (或者光): 30 min	运行时间: 莲蓬头+灯: 无止境地
---------------------------------------	--	--	-------------------------

标准 最多打开两个 莲蓬头	舒适 1: 所有莲蓬头可以 同时打开	舒适 2: 大量水, 只有 在人造雨时 必要
---------------------	--------------------------	---------------------------------

Raindance Rainfall
28411000

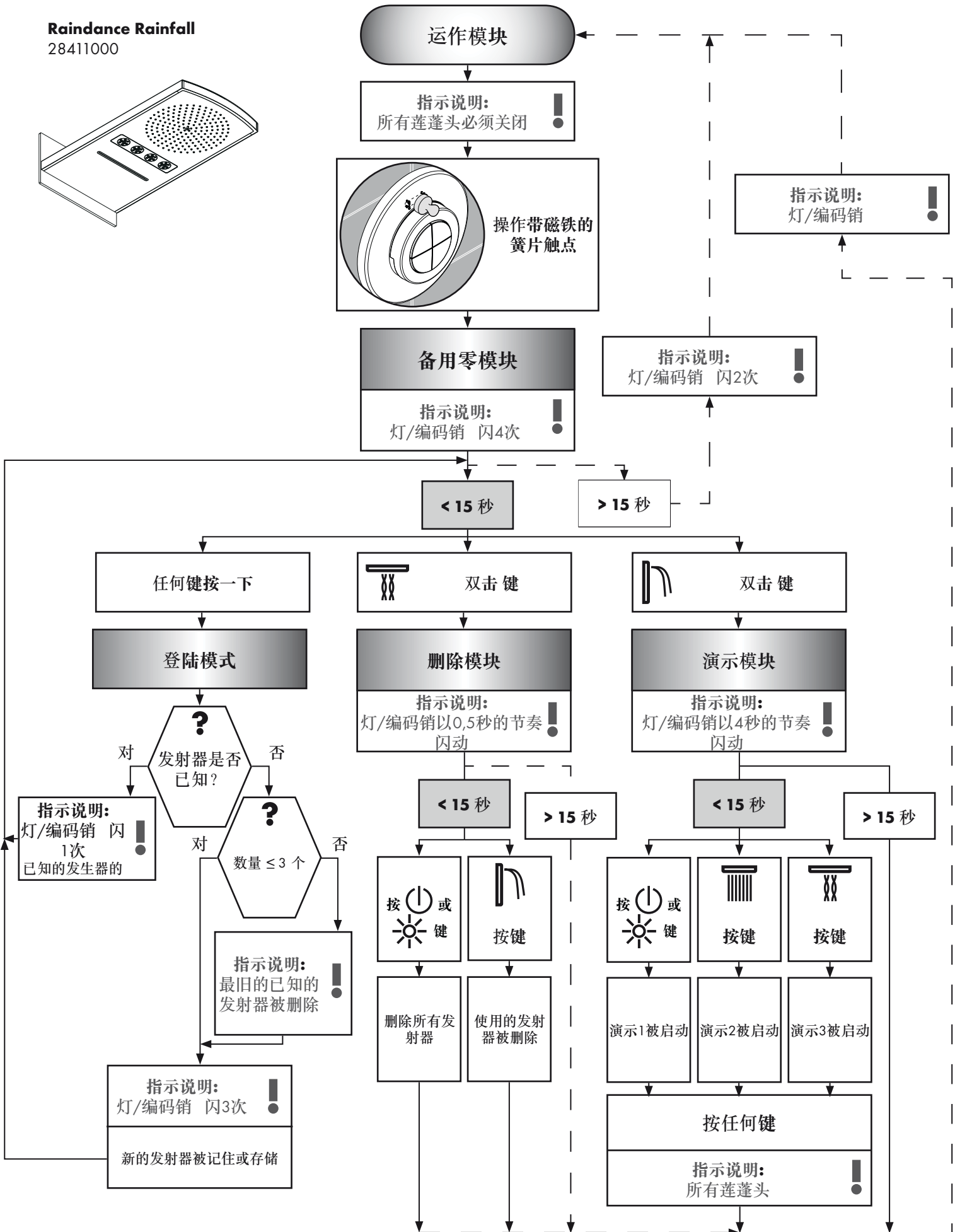
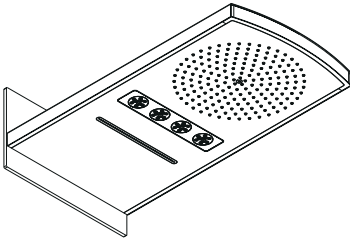

Raindance Rainmaker
28403000 / 28404000

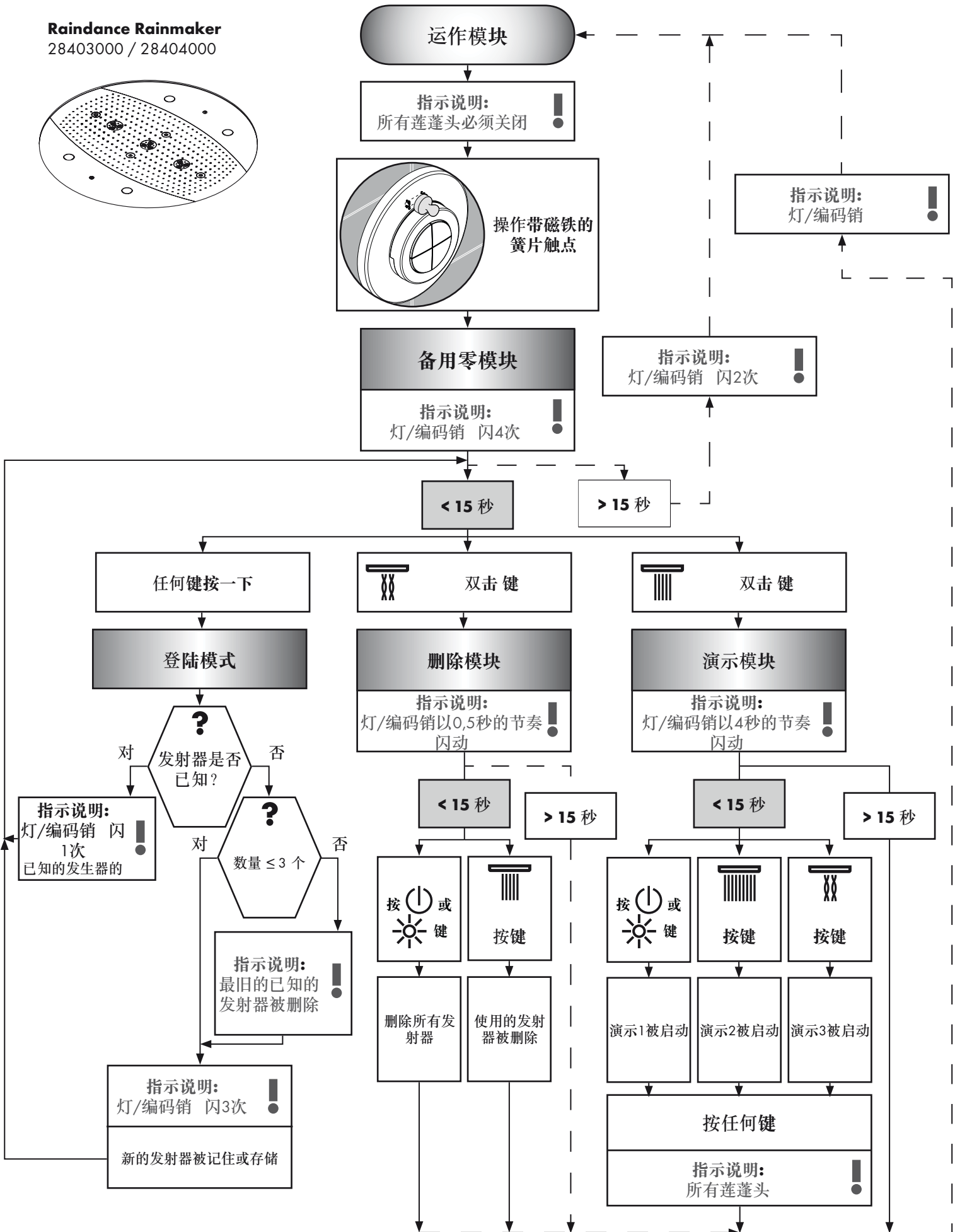
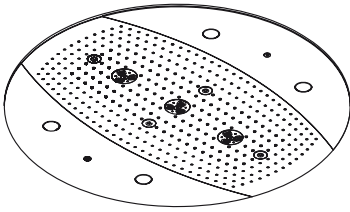

Нормы и директивы:

Применение изделия регулируется следующими директивами:

- EN 15200
- EN 60335-2-105



Указания по технике безопасности:

- Изделие разрешается использовать только в гигиенических целях: для принятия ванны и личной гигиены.
- Дети должны пользоваться душевой системой только под присмотром взрослых.
- Дети, а также взрослые с физическими, умственными и/или сенсорными недостатками должны пользоваться душевой системой только под присмотром. Запрещается пользоваться душевой системой в состоянии алкогольного или наркотического опьянения.
- Не допускайте попадания струи воды из разбрызгивателя на чувствительные части тела (например, на глаза). Разбрызгиватель следует устанавливать на достаточном расстоянии от тела.
- донного клапа. Перед установкой смесителя необходимо регулировочными кранами выровнять давление холодной и горячей воды при помощи вентилей регулирующих подачу воды в квартиру.



Электроподключение:

- Установочные и проверочные работы проводятся специалистами-электриками, имеющими допуск к работе, с соблюдением VDE 0100, часть 701, и IEC 60364-7-701.
- Для электрического подключения требуется только одна штепсельная розетка. Электроснабжение организуется через внешний трансформатор.
- В непосредственной близости не разрешается нахождение легковоспламеняющихся материалов.
- Температура окружающей среды должна быть не более 50 °С.
- Общее электроснабжение организуется подключением к сети переменного тока 230 В и 50 Гц с нейтралью и защитным заземлением.
- Требуется организовать защиту с помощью устройства защитного отключения (выключателя дифференциального тока)
- с уставкой дифференциального тока ≤ 30 мА.
- Если требуется выравнивание потенциалов, то оно должно выполняться заказчиком.
- При электромонтаже следует соблюдать соответствующие предписания Союза немецких электротехников (VDE), государственные нормы и предписания Европейского объединения исследований несчастных случаев (EVU) в действующей редакции.
- Необходимо обеспечить возможность отключения изделия от сети электропитания. Для этой цели предусматривают либо свободно доступный штекер, либо выключатель, прерывающий ток на всех полюсах согласно EN 60335-1, раздел 24.3.



Монтаж: (см. стр. 303)

- **ВНИМАНИЕ!** Смеситель должен быть смонтирован по действующим нормам и в соответствии с настоящей инструкцией, проверен на герметичность и безупречность работы. (Установка, согласно EN 1717) См. инструкцию по монтажу: Raindance Rainfall 28411000 Raindance Rainmaker 28403000 / 28404000 / 28417000 / 28418000
- Все работы разрешается выполнять только в обесточенном состоянии.
- Основная часть 15941180 может устанавливаться только вертикально! Монтаж с регулируемым кольцом (A) возможен только в передней и средней области!
- После установки убедитесь, что возможен доступ ко всем компонентам.

Технические данные:

Рабочее давление::	не более 1 МПа
Рекомендуемое рабочее давление:	0,1 - 0,5 МПа
Давлении::	1,6 МПа
(1 МПа = 10 bar = 147 PSI)	
Температура горячей воды::	не более 80° С
Рекомендуемая темп. гор. воды:	65° С
Размеры подключения:	G 3/4
Подключение Вход:	Смешанная вода
Свободное истечение при 0,3 МПа:	
1 Потребитель:	35 л/мин
2 Потребитель:	45 л/мин



Принадлежности: (см. стр. 124)



Размеры: (см. стр. 292)



варианты установки Raindance Rainfall: (см. стр. 295)



варианты установки Raindance Rainmaker: (см. стр. 299)



Эксплуатация: (см. стр. 126)

- При сбое подачи электропитания 230 В душевое оборудование не работает.
- Изделие не предназначено для использования в паровой бане!





























Очистка Улавливающий фильтр: (см. стр. 309)

Запасные части (см. стр. 311)

Русский Техническая информация

Неисправность	Причина	Устранение неисправности
Нет функции	<ul style="list-style-type: none"> - Нет электропитания - Трансформатор основного комплекта неисправен - Приемник установлен неправильно/исправен - Передатчик не настроен/исправен 	<ul style="list-style-type: none"> - Обеспечьте электропитание - Замените трансформатор - Измените положение приемника или замените приемник - Настройте/замените передатчик
Невозможно настроить режим эксплуатации	<ul style="list-style-type: none"> - Геркон установлен не в надлежащем положении за розеткой - Геркон неисправен 	<ul style="list-style-type: none"> - Установите геркон на розетке - Замените соединительный провод электромагнитного клапана
Подсветка не функционирует	<ul style="list-style-type: none"> - Трансформатор Rainmaker не подключен/исправен - Провода реле подсветки неисправны 	<ul style="list-style-type: none"> - Обеспечьте электропитание трансформатора/замените трансформатор - Проверьте/замените соединения и реле подсветки
Потребители выключаются автоматически	<ul style="list-style-type: none"> - Время работы задано в режиме программы 	<ul style="list-style-type: none"> - Увеличьте/отключите режим ожидания в режиме обслуживания
Арматура негерметична	<ul style="list-style-type: none"> - Электромагнитный клапан загрязнен/исправен 	<ul style="list-style-type: none"> - Очистите/замените мембрану электромагнитного клапана
Недостаточный расход воды	<ul style="list-style-type: none"> - Грязеуловитель со стороны впуска загрязнен 	<ul style="list-style-type: none"> - Очистите / замените грязеулавливающее сито

Символы

	Подключение воды DN 20 Теплая вода		трансформатор		Выравнивание потенциалов
	Подключение воды DN 20 Холодная вода		Приемник		Все выкл
	откройте воду		Кодированная штепсельная вилка		Освещение
	Закройте воду		230V		Rain
	Гарантированное функционирование при показателях свыше *.		12V		Whirl
	Слив должен иметь производительность более 50 л/мин.		Пустая труба		Rainflow
	Слив		Управление светом 27189000 (не поставляется в комплекте!)		Rain AIR XXL
	Середина душевой ванны		Реле освещения Rainmaker		Rain AIR
			трансформатор Rainmaker		Силикон (не содержит уксусной кислоты!)
			Существующая розетка 12 В для подсветки (макс. 80 Вт)		

Монтаж см. стр. 303

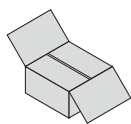

Русский Принадлежности

трансформатор:

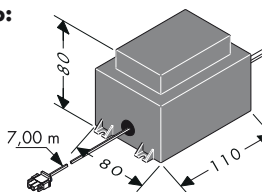

Мощность внешнего трансформатора составляет 50 ВА. Трансформатор должен устанавливаться в сухой области (защитная зона 3). Трансформатор может устанавливаться вместе с приемником в пластмассовый корпус с соблюдением EN/IEC 60335-1. (примерные габариты 250 x 160 x 92 мм, не входит в комплект.) Входящий в комплект кабель позволяет устанавливать трансформатор на расстоянии 7 м от приемника. Для этого требуется предусмотреть пустотелую трубу EN35 (не входит в комплект). Пустотелая труба должна закрепляться по меньшей мере на протяжении всех 500 мм, и радиус поворота должен быть больше 100 мм.

Линия вторичной цепи трансформатора дли-

ной примерно 7 м не может быть сокращена. Неиспользованную часть линии следует разместить поблизости от защитного трансформатора. Поврежденная соединительная линия заменяться не может. В этом случае эксплуатация трансформатора не допускается.

Поврежденная соединительная линия заменяться не может. В случае неисправности сетевого подключения квалифицированный электрик должен заменить провод вместе с трансформатором.

Реле освещения:

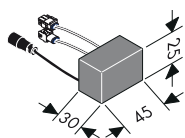

(только для исполнения со встроенной подсветкой)

Реле освещения при напряжении 12 В переменного тока может иметь максимальную нагрузку 80 Вт.

Подключение к сети 230 В недопустимо.

Управление светом:

27189000

(не включено в объем поставки!)

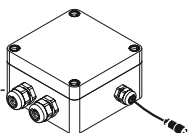

(iControl mobile 15944000)

Управление освещением должно отключаться в вариантах с внешним источником освещения.

Управление освещением должно быть всегда доступно.

Кодированная штепсельная вилка:



(Raindance Rainfall 28411000 / Raindance Rainmaker 28403000)

Кодированная штепсельная вилка должна присоединяться в вариантах без освещения.

Если в вариантах без освещения активирован режим обслуживания, то светодиод кодированной штепсельной вилки индицирует сигналы обратной связи.

Кодирующий штекер должен быть всегда доступен.

Соединительная линия Блок электромагнитного клапана / Соединительная линия Освещение:



Линия длиной 7,50 м блока электромагнитного клапана, а также линия освещения длиной 10 м не могут быть сокращены. Неиспользованную часть линии следует разместить поблизости от приемника.

Линия блока электромагнитного клапана и линия освещения могут прокладываться только во входящей в комплект пустотелой трубе (EN 20).

Пустотелая труба должна закрепляться по меньшей мере на протяжении всех 500 мм, и радиус

поворота должен быть больше 100 мм.

ВНИМАНИЕ: В пустотелых трубах для линии блока электромагнитного клапана и линии освещения запрещена прокладка электрических линий с напряжением выше 12 В.

Монтаж см. стр. 303

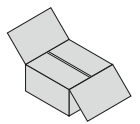

Приемник:

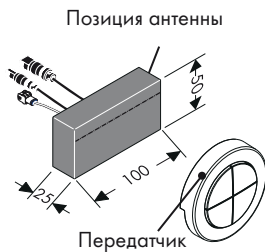

Приемник и душевое оборудование рекомендуется установить в одном помещении.

Если это невозможно, то приемник может также монтироваться в помещении, которое примыкает к помещению с установленным душевым оборудованием.

Приемник не может устанавливаться в металлическом корпусе, так как иначе радиосигналы передатчика экранируются. Кроме того, необходимо свести к минимуму число экранирующих металлических частей поблизости от места

установки приемника.

Для оптимального распознавания радиосигналов антенна приемника должна быть обращена по мере возможности на передатчик.

Передатчик:



При поставке передатчик уже настроен на приемник. Если передатчик и приемник имеют одинаковые серийные номера, то можно выполнить их сопряжение.

В случае с дополнительными или приобретенными впоследствии передатчиками требуется их настройка. Возможны настройка и сохранение не более четырех передатчиков. (см. стр. 130/131 Режим уведомления).

Радиочастота передатчика равна 868,3 МГц.

Указание: Приемник и передатчик имеют дальность действия примерно 10 м. Дальность действия зависит от того, насколько сильно гасятся радиосигналы между передатчиком и приемником.

Указание: По соображениям безопасности используйте передатчик только в области видимости душевой системы. В противном случае возможно случайное включение воды.

Указание: Правильный порядок действий при замене неисправного передатчика на новый:

1. Удалите все передатчики. (Режим уведомления ⇒ Режим удаления).
2. Снова настройте все передатчики, кроме неисправного. (Режим гарнитурный ⇒ Режим уведомления).

Материал	Гашение
Дерево, гипс, стекло (непокрытые, без металла)	0 - 10 %
Кирпич, древесно-стружечная плита	5 - 35 %
Армированный железом бетон	10 - 90 %
Металл, покрытый алюминием	90 - 100 %

Магнит:



Для активизации сервисного режима необходимо привести в действие магнит REED-контакт (за розеткой). (см. стр. 128/129, Режим гарнитурный).

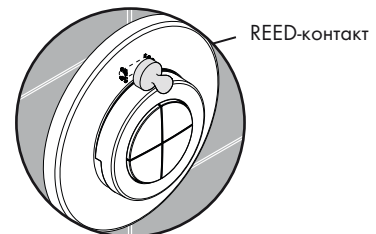

Русский Эксплуатация

Raindance Rainfall

28411000

iControl mobile

15940180 / 15942000

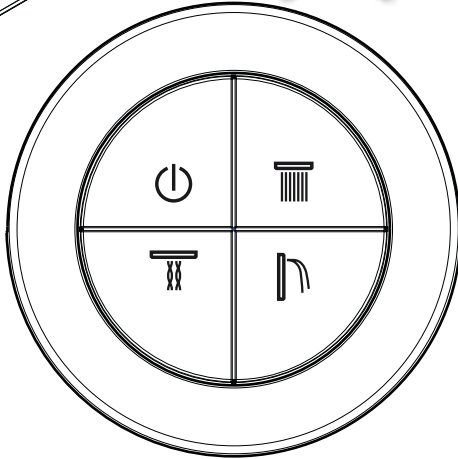
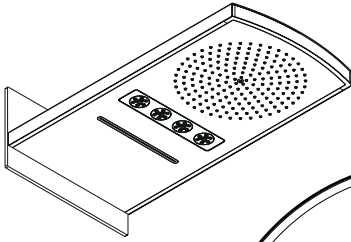

Raindance Rainfall

28411000

iControl mobile

15941180 / 15944000

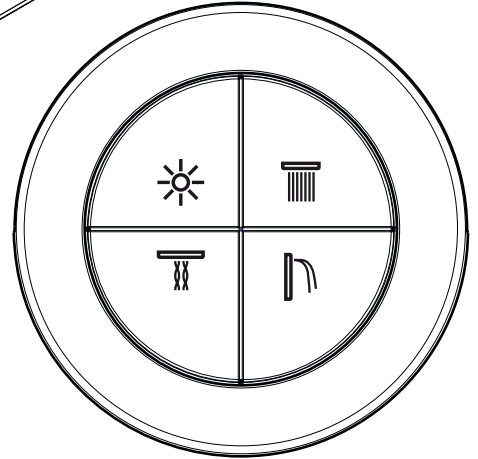
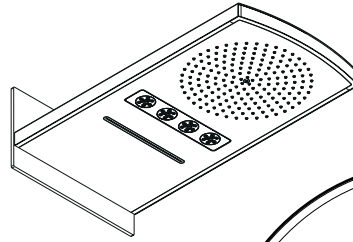

Raindance Rainmaker

28403000

iControl mobile

15940180 / 15943000

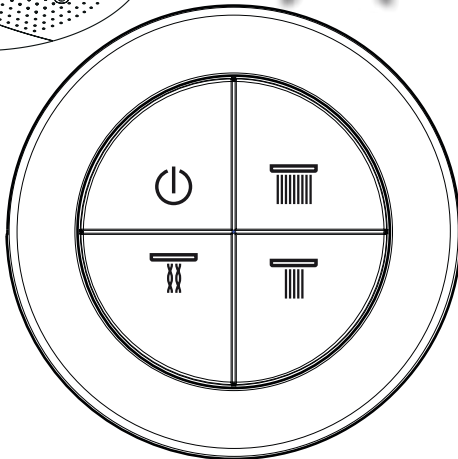
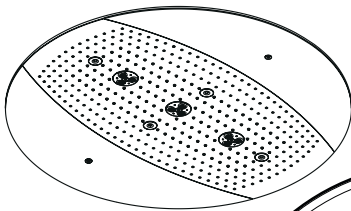

Raindance Rainmaker

28404000

iControl mobile

15941180 / 15945000

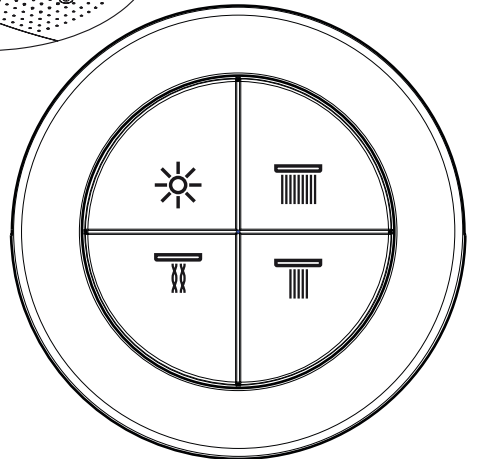
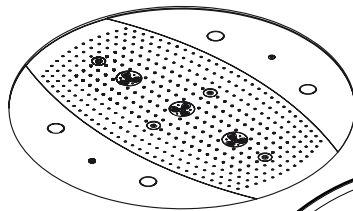

Все выкл



Rain



Whirl



Rainflow



Освещение



Rain AIR XXL



Rain AIR

Монтаж см. стр. 303

Включить и выключить разбрызгивание и освещение:
(Стандартная функция с освещением)

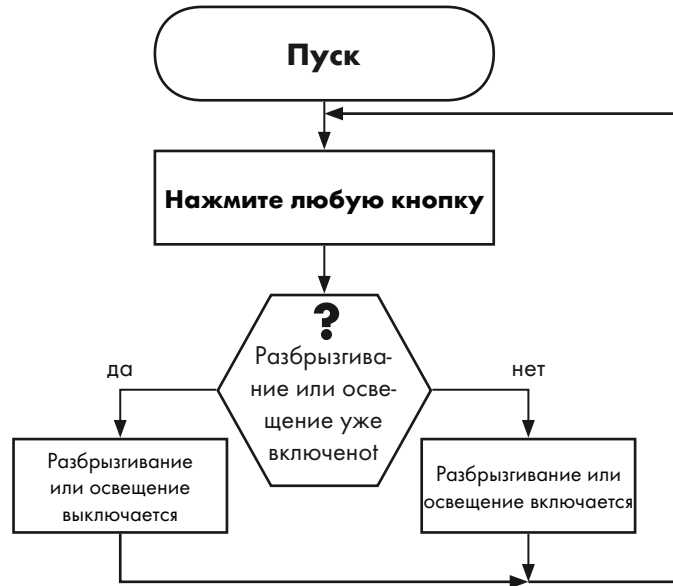

Включить и выключить разбрызгивание:
(Стандартная функция без освещения)

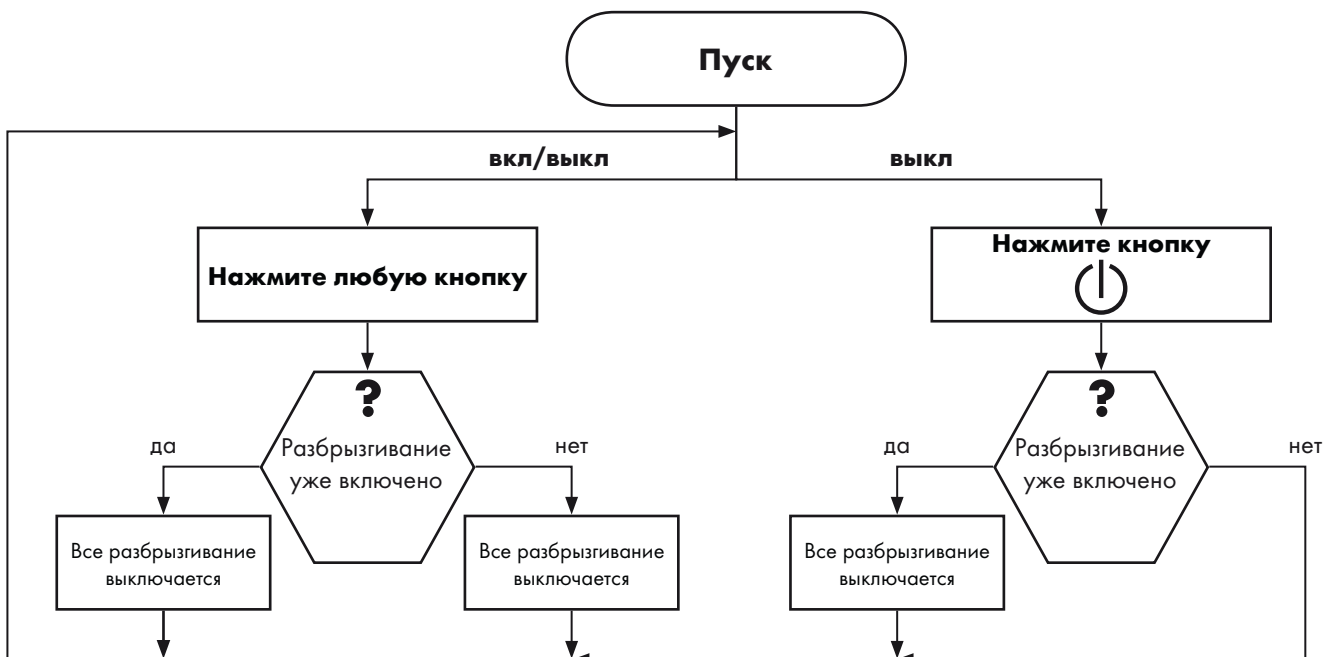

Русский

Уровень пользователя

Raindance Rainfall
28411000

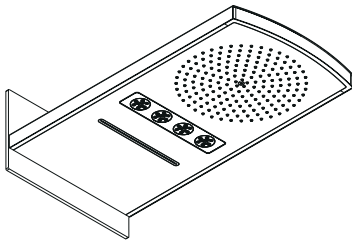

Режим эксплуатации

Указание:
Все разбрызгивание должно быть выключено



Управляйте герконом с помощью магнита

Режим гарнитурный

Указание:
Освещение/кодированная штепсельная вилка мигает 4 раза

Указание:
Освещение/кодированная штепсельная вилка мигает 2 x

Указание:
Освещение/кодированная штепсельная вилка гаснет

< 15 сек.

> 15 сек.

Дважды нажмите кнопку



Режим максимального времени работы

Указание:
Освещение/кодированная штепсельная вилка мигает с частотой 1 с

Дважды нажмите кнопку

Режим разбрызгивания

Указание:
Освещение/кодированная штепсельная вилка мигает с частотой 2 с

< 15 сек.

> 15 сек.

< 15 сек.

> 15 сек.

Нажмите кнопку или	Нажмите кнопку	Нажмите кнопку	Нажмите кнопку
--------------------	----------------	----------------	----------------

Нормы времени работы: Разбрызгивание: 30 s Освещение: 30 min	Стандарт: Нормы времени работы: Разбрызгивание: 60 s Освещение: 30 min	Нормы времени работы: Разбрызгивание: 180 s Освещение: 30 min	Нормы времени работы: Разбрызгивание + освещение: непрерывный режим
---	--	--	---

Нажмите кнопку или	Нажмите кнопку
--------------------	----------------

Стандарт Можно включить не более 2 источников разбрызгивания	Комфорт 1: Можно включить одновременно все источники разбрызгивания
--	---

Русский

Уровень пользователя

Raindance Rainmaker
28403000 / 28404000

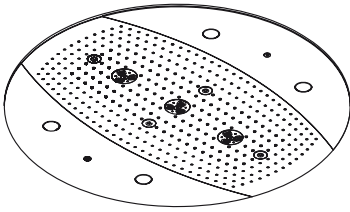

Режим эксплуатации

Указание:
Все разбрызгивание должно быть выключено



Режим гарнитурный

Указание:
Освещение/кодированная штепсельная вилка мигает 4 раза

Указание:
Освещение/кодированная штепсельная вилка мигает 2 x

Указание:
Освещение/кодированная штепсельная вилка гаснет

< 15 сек.

> 15 сек.

Дважды нажмите кнопку
⏻ или ☀️

Дважды нажмите кнопку
⏻

Режим максимального времени работы
Указание:
Освещение/кодированная штепсельная вилка мигает с частотой 1 с

Режим разбрызгивания
Указание:
Освещение/кодированная штепсельная вилка мигает с частотой 2 с

< 15 сек.

> 15 сек.

< 15 сек.

> 15 сек.

Нажмите кнопку или ☀️	Нажмите кнопку ⏻	Нажмите кнопку ⏻	Нажмите кнопку ⏻
Нормы времени работы: Разбрызгивание: 30 s Освещение: 30 min	Стандарт: Нормы времени работы: Разбрызгивание: 60 s Освещение: 30 min	Нормы времени работы: Разбрызгивание: 180 s Освещение: 30 min	Нормы времени работы: Разбрызгивание + освещение: непрерывный режим

Нажмите кнопку или ☀️	Нажмите кнопку ⏻	Нажмите кнопку ⏻
Стандарт Можно включить не более 2 источников разбрызгивания	Комфорт 1: Можно включить одновременно все источники разбрызгивания	Комфорт 2: Большое количество воды, необходимо только при исполнении Rainmaker

Русский Уровень эксперта

Raindance Rainfall
28411000

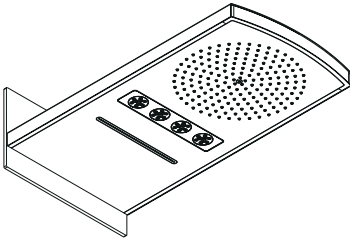

Режим эксплуатации

Указание:
Все разбрызгивание должно быть выключено



Указание:
Освещение/кодированная штепсельная вилка гаснет

Режим гарнитурный

Указание:
Освещение/кодированная штепсельная вилка мигает 4 раза

Указание:
Освещение/кодированная штепсельная вилка мигает 2 раза

< 15 сек.

> 15 сек.

Нажмите любую кнопку 1 раз

Режим уведомления



Указание:
Освещение/кодированная штепсельная вилка мигает 1 x

Указание:
Предыдущие известные передатчики удалены

Указание:
Освещение/кодированная штепсельная вилка мигает 3 x

Новый передатчик настроен или сохранен

Дважды нажмите кнопку

Режим удаления

Указание:
Освещение/кодированная штепсельная вилка мигает с частотой 0,5 с

< 15 сек.

> 15 сек.

Нажмите кнопку **или**

Все передатчики удаляются

Нажмите кнопку

Используемый передатчик удаляется

Дважды нажмите кнопку

Режим презентации

Указание:
Освещение/кодированная штепсельная вилка мигает с частотой 4 с

< 15 сек.

> 15 сек.

Нажмите кнопку **или**

Начинается 1 презентация

Нажмите кнопку

Начинается 2 презентация

Нажмите кнопку

Начинается 3 презентация

Нажмите любую кнопку

Указание:
Все источники разбрызгивания выключаются

Русский Уровень эксперта

Raindance Rainmaker
28403000 / 28404000

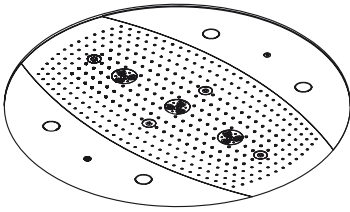

Режим эксплуатации

Указание:
Все разбрызгивание должно быть выключено



Управляйте герконом с помощью магнита

Указание:
Освещение/кодированная штепсельная вилка гаснет

Режим гарнитурный

Указание:
Освещение/кодированная штепсельная вилка мигает 4 раза

Указание:
Освещение/кодированная штепсельная вилка мигает 2 раза

< 15 сек.

> 15 сек.

Нажмите любую кнопку 1 раз

Режим уведомления



Указание:
Освещение/кодированная штепсельная вилка мигает 1 x



Указание:
Предыдущие известные передатчики удалены

Указание:
Освещение/кодированная штепсельная вилка мигает 3 x

Новый передатчик настроен или сохранен

Дважды нажмите кнопку

Режим удаления

Указание:
Освещение/кодированная штепсельная вилка мигает с частотой 0,5 с

< 15 сек.

> 15 сек.

Нажмите кнопку

Все передатчики удаляются

Нажмите кнопку

Используемый передатчик удаляется

Дважды нажмите кнопку

Режим презентации

Указание:
Освещение/кодированная штепсельная вилка мигает с частотой 4 с

< 15 сек.

> 15 сек.

Нажмите кнопку

Начинается 1 презентация

Нажмите кнопку

Начинается 2 презентация

Нажмите кнопку

Начинается 3 презентация

Нажмите любую кнопку

Указание:
Все источники разбрызгивания выключаются

Szabványok és irányelvek:

A termék használatát a következő irányelvek biztosítják:

- EN 15200
- EN 60335-2-105



Biztonsági utasítások:

- A terméket csak fürdéshez, mosakodáshoz, és egészségügyi tisztálkodáshoz szabad használni.
- Gyermek felügyelet nélkül nem használhatja a zuhany rendszert.
- Gyermek, valamint testileg, szellemileg fogyatékos vagy érzékelésben korlátozott személyek nem használhatja felügyelet nélkül a zuhanyrendszert. Alkohol és kábítószer befolyása alatt álló személyek nem használhatja a zuhanyrendszert.
- Kerülni kell a zuhany sugar érintkezését érzékeny testrészekkel (pl. szemek). Be kell tartani a megfelelő távolságot a zuhanyfej és a test között.
- A hidegvíz- és a melegvíz-csatlakozások közötti nagy nyomáskülönbséget kikell egyenlíteni!



Elektromos csatlakozás:

- Az installációs és ellenőrző munkákat jóváhagyott elektromos szakembernek kell elvégezni, a VDE 0100 701. része és az IEC 60364-7-701, figyelembevétele mellett.
- Az elektromos csatlakozáshoz csupán egy dugaljra van szükség. Az áramellátás egy külső trafón keresztül történik.
- A közvetlen közelben nem lehetnek könnyen gyulladó anyagok.
- A környezeti hőmérséklet nem lehet magasabb 50 C°-nál.
- A teljes áramellátás egy 230V/N/PE/50Hz váltóáram csatlakozón keresztül történik.
- A biztosítást egy hibaáram-mentesítő (RCD/ FI) útján, egy 30 mA-nál kisebb hálózati váltóáram segítségével kell megvalósítani.
- Ha feszültség kiegyenlítésre van szükség, akkor ezt gyárilag kell elvégezni.
- Az elektromos szerelés közben a mindenkor érvényes keretek között be kell tartani a megfelelő VDE, országspecifikus, és EVU előírásokat.
- Biztosítani kell, hogy a terméket az áramhálózatról le lehessen választani. Vagy egy szabadon hozzáférhető dugós csatlakozó vagy egy EN 60335-1 24.3 bek.-nek megfelelő mindenpólusú kapcsoló által.



Szerelés: (lásd a oldalon 303)

- Figyelem! A csaptelepet az érvényben lévő előírásoknak megfelelően kell felszerelni, átöblíteni és ellenőrizni. (Szerelés EN 1717 szerint) Lásd a szerelési útmutatót:
Raindance Rainfall 28411000
Raindance Rainmaker 28403000 / 28404000 / 28417000 / 28418000
- Minden munkát csak feszültségmentes állapotban szabad végezni.
- A 15941180 sz. alaptestet csak függőlegesen lehet beépíteni! Felszerelés állítógyűrűvel (A) csak az első és a középső területen lehetséges!
- Minden komponensnek hozzáférhetőnek kell maradni.

Műszaki adatok:

Üzemi nyomás::	max. 1 MPa
Ajánlott üzemi nyomás:	0,1 - 0,5 MPa
Nyomáspróba::	1,6 MPa
(1 MPa = 10 bar = 147 PSI)	
Forróvíz hőmérséklet::	max. 80° C
Forróvíz javasolt hőmérséklete:	65° C
Csatlakozási méret:	G 3/4
Csatlakozás Bemenet:	Kevert víz
Szabad átfolyás 0,3 MPa nyomás esetén:	
1 Felhasználó:	35 l/perc
2 Felhasználó:	45 l/perc



Tartozék: (lásd a oldalon 134)



Méretet: (lásd a oldalon 292)



Szerelési példák Raindance Rainfall: (lásd a oldalon 295)



Szerelési példák Raindance Rainmaker: (lásd a oldalon 299)



Használat: (lásd a oldalon 136)

- A 230 V hálózati feszültség kiesése esetén a zuhanyberendezést nem lehet üzembe helyezni.
- A terméket nem gőzfürdővel együttes használatra tervezték!



Tisztítás Szűrőt tisztítani: (lásd a oldalon 309)



























Alkatrészek (lásd a oldalon 311)

Szerelés lásd a oldalon 303

Magyar Műszaki információk

Hiba	Ok	Megoldás
Nincs funkció	<ul style="list-style-type: none"> - Nincs feszültség ellátás - Az alapkészlet trafója meghibásodott - A vevő rossz helyen van / meghibásodott - Az adó nincs betanítva / hibás 	<ul style="list-style-type: none"> - A feszültség ellátást biztosítani kell - Trafót kicserélni - A vevő helyzetét megváltoztatni ill. a vevőt kicserélni - Adót betanítani / kicserélni
Az üzemmódot nem lehet konfigurálni	<ul style="list-style-type: none"> - A Reed érintkező nem megfelelő helyen van a rozetta mögött - A Reed érintkező hibás 	<ul style="list-style-type: none"> - A Reed érintkezőt a rozettára helyezni - A mágnes szelep csatlakozó vezetékét kicserélni
Nem működik a lámpa	<ul style="list-style-type: none"> - A Rainmaker trafója nincs bedugva / hibás - A lámpa relé vezetéke hibás / meghibásodott 	<ul style="list-style-type: none"> - A trafó feszültség ellátását biztosítani / trafót kicserélni - A lámpa relé csatlakozásait ellenőrizni / kicserélni
A felhasználók maguktól lekapcsolódnak	<ul style="list-style-type: none"> - A működési idő a program üzemmódban van megadva 	<ul style="list-style-type: none"> - Az utánjárás időt a szerviz üzemmódban meghosszabbítani / kikapcsolni
Csaptelep szívárog	<ul style="list-style-type: none"> - A mágnes szelep szennyezett / meghibásodott 	<ul style="list-style-type: none"> - A mágnes szelep membránját tisztítani / kicserélni
Túl alacsony átfolyás	<ul style="list-style-type: none"> - A szennyfogó szűrő a bemeneti oldalon szennyezett 	<ul style="list-style-type: none"> - Szennyfogó szűrő tisztítása / cseréje

Zimbólumok

	Vízcsatlakozás DN 20 Melegvíz		Trafó		Potenciálkiegyenlítés
	Vízcsatlakozás DN 20 Hidegvíz		Vevő		minden ki
	Nyissuk meg a vizet.		Kódoló dugasz		Lámpa
	Zárjuk el a vizet		230V		Rain
	A • -től működik az adott funkció.		12V		Whirl
	A lefolyó teljesítményének 50l/percnél magasabbnak kell lenni > 50 l/min		Üres cső		Rainflow
	Lefolyó		Fényvezérlő 27189000 (a szállítási egység nem tartalmazza!)		Rain AIR XXL
	Zuhanytálca közepe		Lámpa relé Rainmaker		Rain AIR
			Trafó Rainmaker		Szilikon (ecetsavmentes!)
			Gyárilag előre beépített 12 V-os csatlakozó a lámpához (max. 80 W)		

Szerelés lásd a oldalon 303

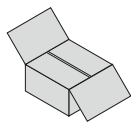

Magyar Tartozék

Trafó:

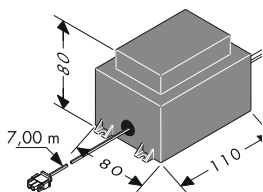

A külső trafó teljesítménye 50 VA. A trafót száraz területen (3. védelmi zóna) kell telepíteni. A trafót a vevővel együtt be lehet építeni egy műanyag burkolatba az EN/IEC 60335-1 figyelembevételével. (méretek kb. 250 x 160 x 92 mm, nem része a szállítási terjedelemnek.) A mellékelt kábel lehetővé teszi, hogy a trafót a vevőtől egészen 7,00 m távolságra szereljék fel. Ehhez egy EN35 (nem része a szállítási terjedelemnek) üres csövet kell behelyezni. Az üres csövet legalább 500 mm-ként rögzíteni kell és a hajlítási rádiusznak 100 mm-nél nagyobbaknak kell lenni.

A trafó kb. 7,00 m hosszú szekunder vezetékét nem szabad lerövidíteni. A vezeték azon részét, amelyre nincs szükség a biztonsági transzformá-

tor közelében kell elhelyezni. A megrongálódott csatlakozóvezetékét nem szabad kicserélni. A trafót nem szabad tovább üzemeltetni.

A megrongálódott csatlakozóvezetékét nem szabad kicserélni. Hibás hálózati csatlakozókábel esetén a vezetékét, a trafóval együtt, elektromos szakembernek kell kicserélni.

Lámpa relé:

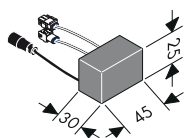

(csak integrált lámpával rendelkező változatok esetén)

A lámpa relét maximum 12 V AC / 80 W szabad terhelni.

Üzemeltetése 230 V-os hálózaton nem megengedett.

Fényvezérlő:

27189000

(a szállítási egység nem tartalmazza)

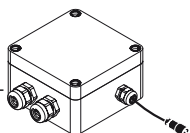

(iControl mobile 15944000)

A fényvezérlést a külső fényforrással rendelkező változatoknál csatlakoztatni kell. A fényvezérlésnek mindig hozzáférhetőnek kell lenni.

Kódoló dugasz:

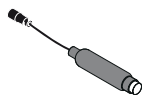

(Raindance Rainfall 28411000 / Raindance Rainmaker 28403000)

A kódoló dugaszt a lámpa nélküli változatoknál kell csatlakoztatni.

Ha a lámpa nélküli változatnál a szerviz mód van beállítva, akkor a kódoló dugasz fénydiódája az optikai visszajelzéseket mutatja.

A kódoló dugasznak mindig hozzáférhetőnek kell lenni.

Csatlakozóvezeték Mágnesszelep egység / Csatlakozóvezeték Lámpa:



A 7,50 m hosszú mágnesszelep egység vezetékét valamint a 10,00 m hosszú lámpa vezetékét nem szabad lerövidíteni. A vezeték azon részét, amelyre nincs szükség a vevő közelében kell elhelyezni.

A mágnesszelep egység vezetékét és a lámpa vezetékét csak a mellékelt üres csővel (EN 20) szabad lefektetni.

Az üres csövet legalább 500 mm-ként rögzíteni kell és a hajlítási rádiusznak 100 mm-nél nagyobbaknak kell lenni.

Figyelem: A mágnes szelep egység vezeték és a lámpa vezeték üres csővébe nem szabad olyan elektromos vezetékeket fektetni, amelyek 12V-nál nagyobb feszültséget vezetnek.

Szerelés lásd a oldalon 303

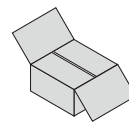

Vevő:

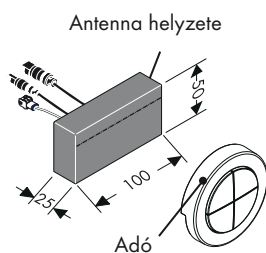

A vevőt ajánlott ugyanabban a helyiségben felszerelni, mint a zuhanyberendezést.

Ha ez nem lehetséges, akkor a vevőt a zuhanyberendezéssel határos helyiségben is fel lehet szerelni.

A vevőt nem szabad fém burkolatba beszerezni, mivel ez az adó rádióhullámait leárnyékolja. Továbbra is ügyelni kell arra, hogy lehetőleg kevés árnyékoló fémrész legyen a vevő beépítési helyének közelében.

A rádióhullámok optimális felismerése érdekében

a vevő antennáját lehetőleg az adó felé kell fordítani.

Adó:



Kiszállításkor a vevő már be van tanítva az adóba. A megegyező sorozatszám által az adót hozzá lehet rendelni a vevőhöz.

A további ill. utólagosan beszerzett adókat be kell tanítani Maximum négy adót lehet betanítani ill. elmenteni. (lásd a oldalon 140/141 Bejelentkezési mód).

Az adó rádiófrekvenciája 868,3 MHz.

Megjegyzés: Helyes eljárás egy meghibásodott adó új adóra cserélése esetén:

1. Minden adó törlése. (Bejelentkezési mód ⇒ Törlés mód).
2. Minden adó, kivéve a meghibásodott adó, ismételt betanítása. (Szervíz mód ⇒ Bejelentkezési mód).

Megjegyzés: A vevő és az adó hatótávolsága kb. 10,00 m. A hatótávolság attól függ, hogy a rádiójelek az adó és a vevő között mennyire gyengülnek.

Megjegyzés: Biztonsági okokból az adót csak a zuhany rendszerből látható helyen szabad használni. Egyébként a vizet véletlenül be lehet kapcsolni.

Anyag	Gyengülés
Fa, gipsz, üveg (nem bevonatos, fém nélkül)	0 - 10 %
Tégla, MDF lapok	5 - 35 %
Beton vasalással	10 - 90 %
Fém, alumínium burkolat	90 - 100 %

Mágnes:



A szervíz mód aktiválásához a mágnesnek működésbe kell hozni a REED érintkezőt (a rozetta mögött). (lásd a oldalon 138/139, Szervíz mód).

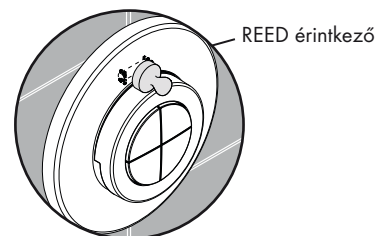

Raindance Rainfall

28411000

iControl mobile

15940180 / 15942000

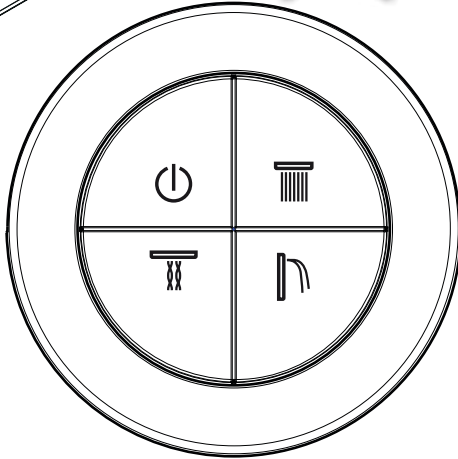
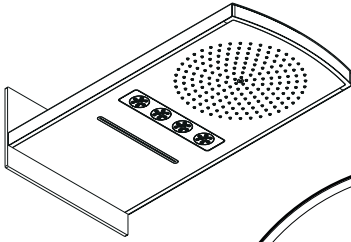

Raindance Rainfall

28411000

iControl mobile

15941180 / 15944000

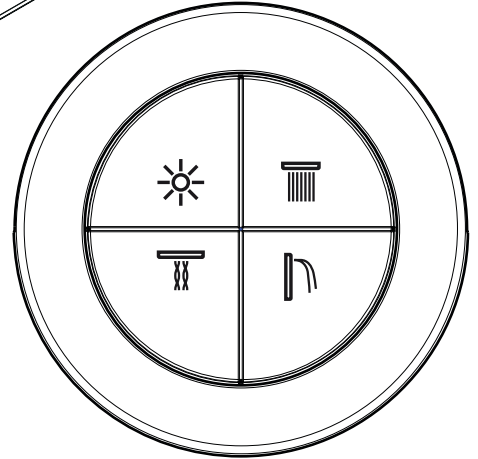
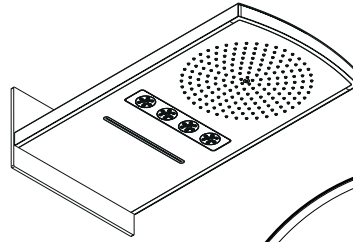

Raindance Rainmaker

28403000

iControl mobile

15940180 / 15943000

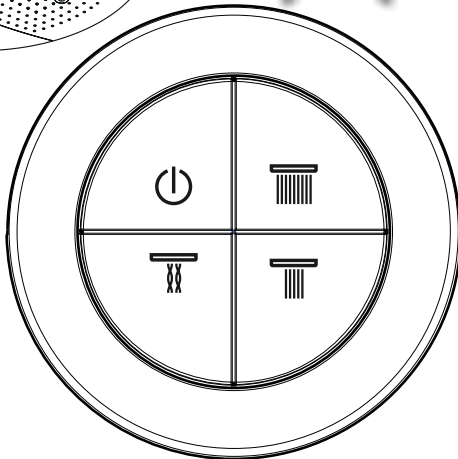
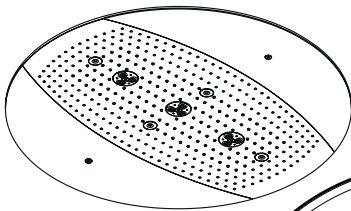

Raindance Rainmaker

28404000

iControl mobile

15941180 / 15945000

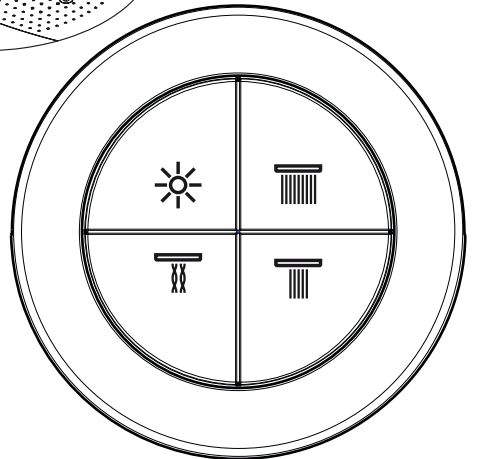
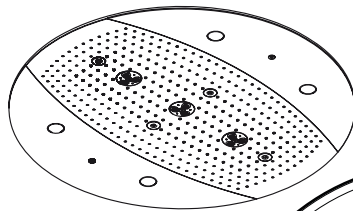

minden ki



Rain



Whirl



Rainflow



Lámpa



Rain AIR XXL



Rain AIR

Szerelés lásd a oldalon 303

Zuhany és lámpa be- és kikapcsolása:

(Standard funkció lámpával)

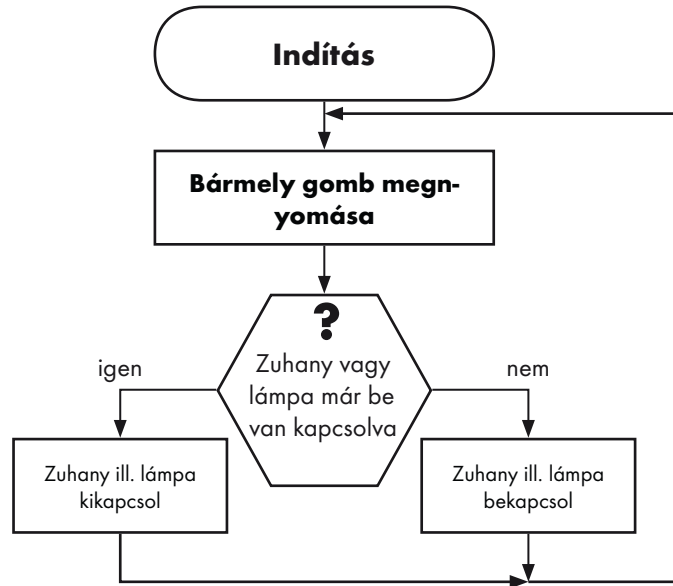

Zuhany be- és kikapcsolása:

(Standard funkció lámpa nélkül)

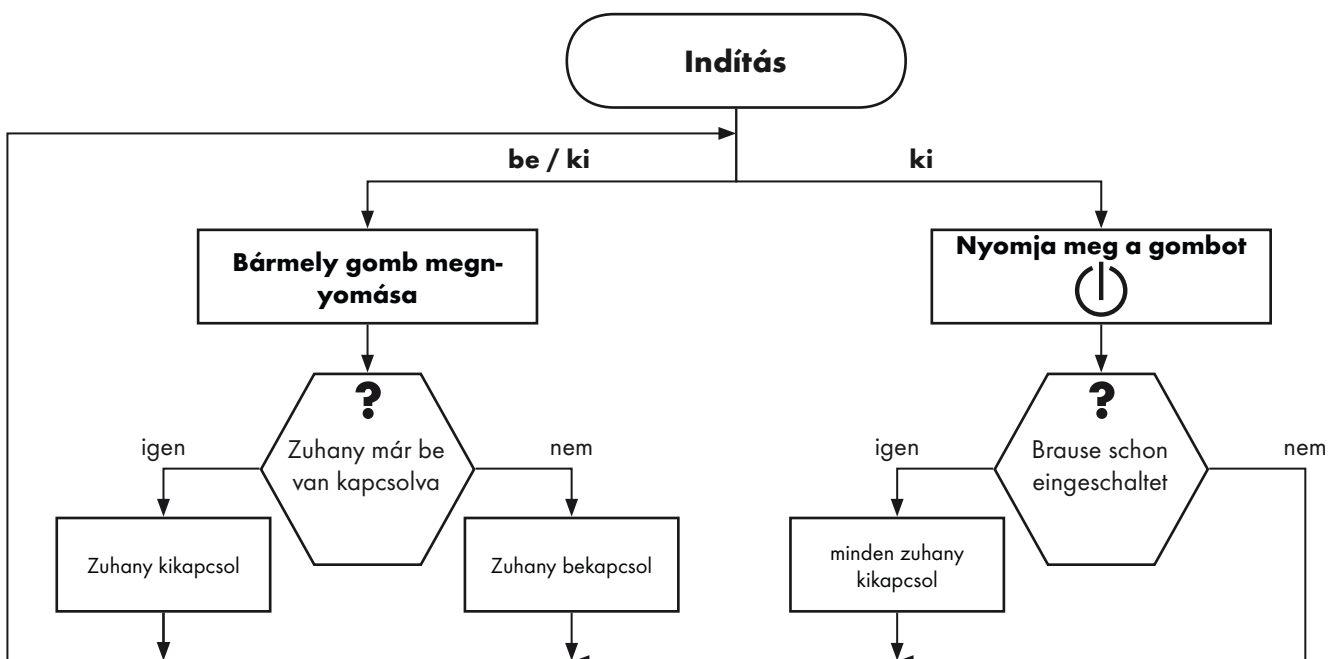

Szerelés lásd a oldalon 303

Magyar Kezelői szint

Raindance Rainfall
28411000

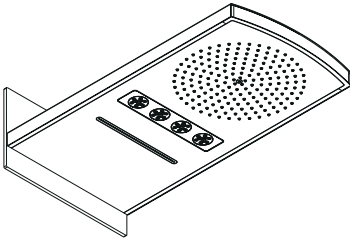

Üzem mód

Megjegyzés:
minden zuhanynak ki kell
kapcsolva lenni !

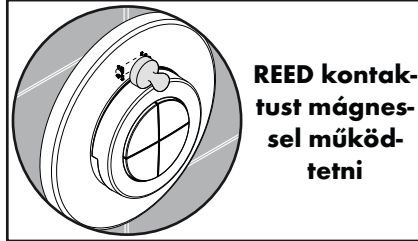

Megjegyzés:
Lámpa / kódoló dugasz
kialszik !

Szervíz mód

Megjegyzés:
Lámpa / kódoló dugasz 4x
villog !

Megjegyzés:
Lámpa / kódoló dugasz 2x
villog !

< 15 mp

> 15 mp

 **vagy**
gombra kétszer kattintani

 **gombra kétszer kattintani**

Maximális menetidő mód

Megjegyzés:
Lámpa / kódoló dugasz
villog 1mp. Időközönként !

Zuhany mód





Megjegyzés:
Lámpa / kódoló dugasz
villog 2mp. Időközönként !

< 15 mp

> 15 mp

< 15 mp

> 15 mp



 vagy gombot megnyomni	 Nyomja meg a gombot	 Nyomja meg a gombot	 Nyomja meg a gombot
---	---	---	---

Menetidő:
Zuhany: 30 s
Lámpa: 30 min

Standard:
Menetidő:
Zuhany: 60 s
Lámpa: 30 min

Menetidő:
Zuhany: 180 s
Lámpa: 30 min

Menetidő:
Zuhany + lámpa:
végtelen

 vagy gombot megnyomni	 Nyomja meg a gombot
---	---

Standard
max. 2 zuhanyt
lehet beállítani

Komfort 1:
minden zuhanyt
egyszerre be
lehet kapcsolni

Magyar Kezelői szint

Raindance Rainmaker
28403000 / 28404000

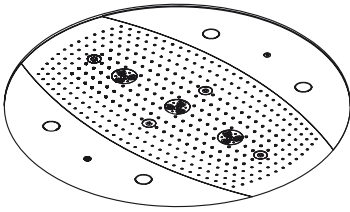

Üzem mód

Megjegyzés:
minden zuhanynak ki kell
kapcsolva lenni

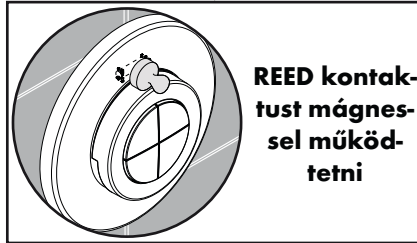

Megjegyzés:
Lámpa / kódoló dugasz
kialszik

Szervíz mód

Megjegyzés:
Lámpa / kódoló dugasz 4x
villog

Megjegyzés:
Lámpa / kódoló dugasz 2x
villog

< 15 mp

> 15 mp

vagy
gombra kétszer kattintani

**gombra kétszer
kattintani**

**Maximális menetidő
mód**

Megjegyzés:
Lámpa / kódoló dugasz
villog 1 mp. Időközönként

Zuhany mód

Megjegyzés:
Lámpa / kódoló dugasz
villog 2 mp. Időközönként

< 15 mp

> 15 mp

< 15 mp

> 15 mp

vagy gombot megnyomni	Nyomja meg a gombot	Nyomja meg a gombot	Nyomja meg a gombot
------------------------------------	------------------------------------	------------------------------------	------------------------------------

Menetidő: Zuhany: 30 s Lámpa: 30 min	Standard: Menetidő: Zuhany: 60 s Lámpa: 30 min	Menetidő: Zuhany: 180 s Lámpa: 30 min	Menetidő: Zuhany + lám- pa: végtelen
---	---	--	---

vagy gombot megnyomni	Nyomja meg a gombot	Nyomja meg a gombot
------------------------------------	------------------------------------	------------------------------------

Standard max. 2 zuhanyt lehet beállítani	Komfort 1: minden zuhanyt egyszerre be lehet kapcsolni	Komfort 2: Nagyobb vízmennyiség, csak a Rain- maker esetén szükséges
---	--	--

Magyar Szakértői szint

Raindance Rainfall
28411000

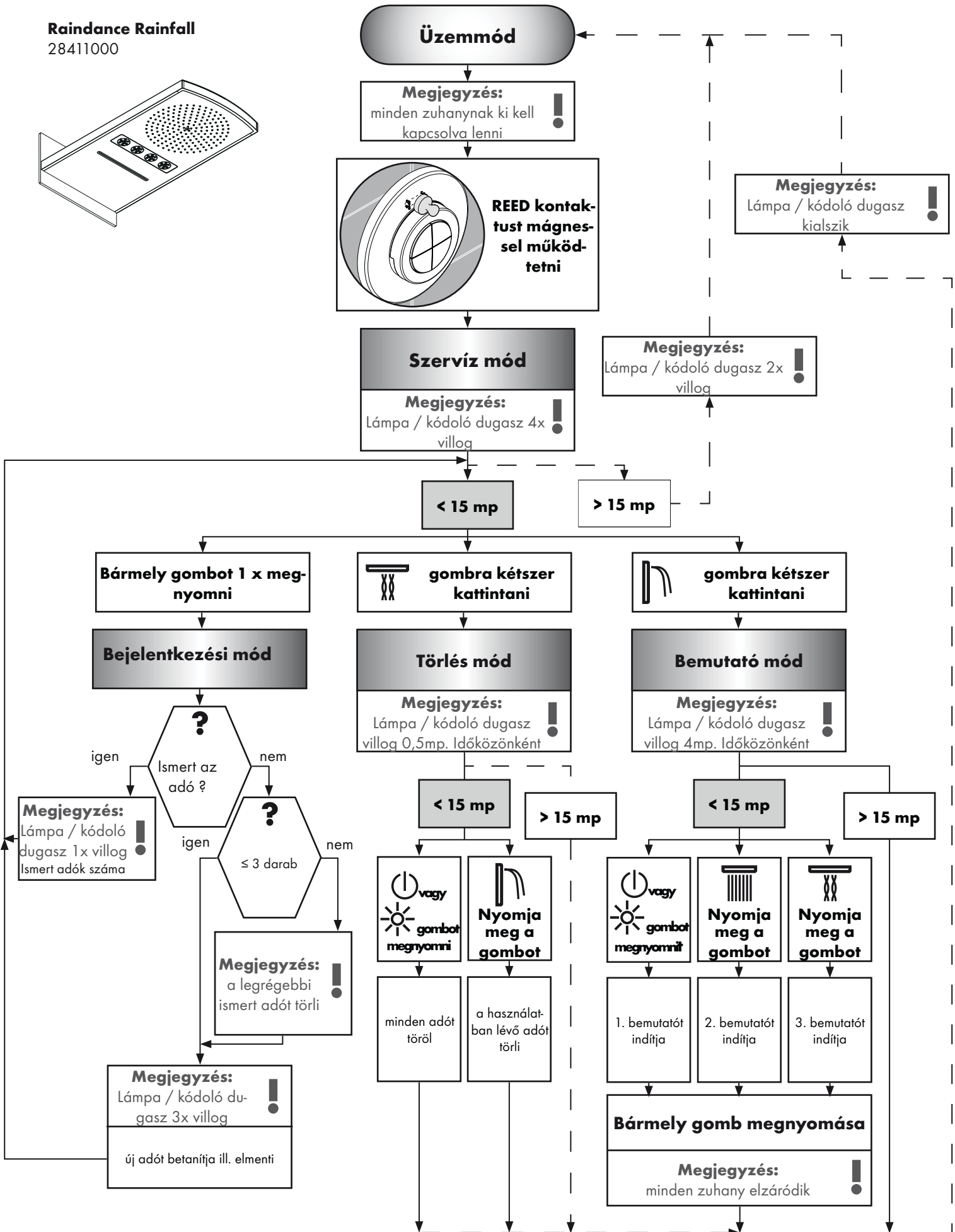
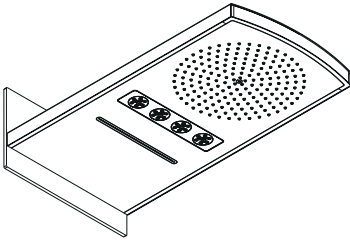

Magyar Szakértői szint

Raindance Rainmaker
28403000 / 28404000

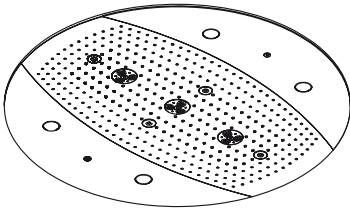

Üzem mód

Megjegyzés:
minden zuhanyynak ki kell kapcsolva lenni !

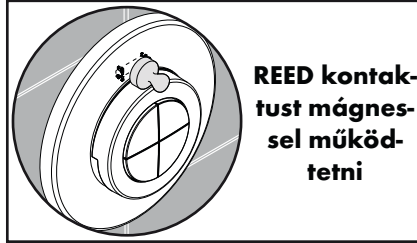

Szervíz mód

Megjegyzés:
Lámpa / kódoló dugasz 4x villog

Megjegyzés:
Lámpa / kódoló dugasz kialszik !

Megjegyzés:
Lámpa / kódoló dugasz 2x villog !

< 15 mp

> 15 mp

Bármely gombot 1 x megnyomni

Bejelentkezési mód

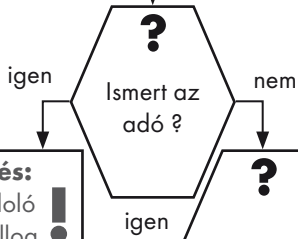

Megjegyzés:
Lámpa / kódoló dugasz 1x villog !
Ismert adók száma

Megjegyzés:
a legrégebbi ismert adót törli !

Megjegyzés:
Lámpa / kódoló dugasz 3x villog !
új adót betanítja ill. elmenti

gombra kétszer kattintani

Törlés mód

Megjegyzés:
Lámpa / kódoló dugasz villog 0,5mp. Időközönként !

< 15 mp

> 15 mp



gombra kétszer kattintani

Bemutató mód

Megjegyzés:
Lámpa / kódoló dugasz villog 4mp. Időközönként !

< 15 mp

> 15 mp

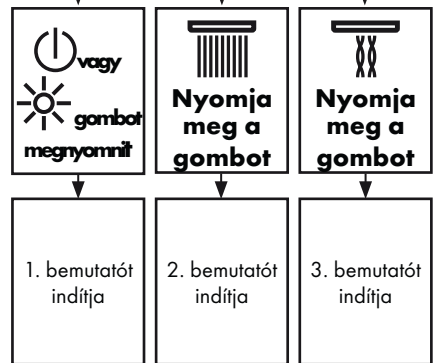

Bármely gomb megnyomása

Megjegyzés:
minden zuhany elzáródik !

Standardit ja direktiivit:

Tuotteen käyttö on taattu seuraavien direktiivien mukaisesti:

- EN 15200
- EN 60335-2-105



Turvallisuusohjeet:

- Suihkujärjestelmää saa käyttää ainoastaan kylpy-, hygienia- ja puhdistustarkoituksiin.
- Lapset eivät saa käyttää suihkujärjestelmää ilman valvontaa.
- Lapset ja ruumiillisesti, henkisesti ja/tai aistillisesti rajoittuneet aikuiset eivät saa käyttää suihkujärjestelmää ilman valvontaa. Alkoholin tai huumeiden vaikutuksessa olevat henkilöt eivät saa käyttää suihkujärjestelmää.
- Suihkuveden kontaktia herkempien ruumiinosien (esim. silmien) kanssa on vältettävä. Suihkun ja vartalon välissä on oltava riittävä väli.
- Suuret paine-erot kylmä- ja kuumavesiliitäntöjen välillä on tasettava.



Sähköliitännät:

- Hyväksytyyn sähköammattilaisen on suoritettava sähköasennus- ja tarkastustyöt VDE 0100 osa 701 ja IEC 60364-7-701 mukaisesti.
- Sähköliitännän tarvitaan vain yksi pistorasia. Sähkönsyöttö tulee ulkopuolisesta muuntajasta.
- Välittömässä läheisyydessä ei saa olla helposti syttyviä materiaaleja.
- Ympäristön lämpötila ei saa olla yli 50 °C.
- Koko virransyöttö tulee 230V/N/PE/50Hz vaihtovirtaliitännästä.
- Varmistus on tehtävä vikavirta-suojalaitetta (RCD/FI), jonka vikavirta-asetus on ≤ 30 mA, käyttäen.
- Jos tarvitaan potentiaalintasausa, se on suoritettava rakennuksen puolella.
- Sähköasennuksessa on noudatettava voimassa olevia, asiaa koskevia VDE-, EVU- ja paikallisia määräyksiä.
- On varmistettava, että tuotteen voi irrottaa sähköverkosta. Joko käyttäen pistoketta, johon pääsee käsiksi, tai standardin EN 60335-1, kohdan 24.3 mukaista kaikkinaapaista katkaisijaa.



Asennus: (katso sivu 303)

- Huomio! Kaluste on asennettava, huuhdeltava ja tarkastettava voimassa olevien määräysten mukaisesti. (Asennus normin EN 1717 mukaisesti) Katso asennusohje:
Raindance Rainfall 28411000
Raindance Rainmaker 28403000 / 28404000 / 28417000 / 28418000
- Kaikki työt saa suorittaa vain jännitteettömässä tilassa.
- Peruskappaleen 15941180 voi asentaa vain pystysuoraan! Asennus säätörengasta (A) käyttäen on mahdollista vain etu- ja keskialueella!
- Kaikkiin komponentteihin tulee päästä käsiksi.

Tekniset tiedot:

Käyttöpaine::	maks. 1 MPa
Suosittelut käyttöpaine:	0,1 - 0,5 MPa
Koestuspaine::	1,6 MPa
(1 MPa = 10 bar = 147 PSI)	
Kuuman veden lämpötila::	maks. 80 °C
Kuuman veden suosituslämpötila:	65 °C
Liitäntämitat:	G 3/4
Liittimet Sisääntulo:	Sekaviemäriveresi
Vapaa läpivirtaus 0,3 MPa paineella:	
1 Kuluttaja:	35 l/min
2 Kuluttaja:	45 l/min



Varusteet: (katso sivu 144)



Mitat: (katso sivu 292)



Asennusesimerkkejä Raindance Rainfall: (katso sivu 295)



Asennusesimerkkejä Raindance Rainmaker: (katso sivu 299)



Käyttö: (katso sivu 146)

- Jos 230 V verkkojännite putoaa pois päältä, suihkulaitteisto ei voi ottaa käyttöön.
- Tuotetta ei ole tarkoitettu käytettäväksi yhdessä höyrykyllyn kanssa!



Puhdistus Likasihti: (katso sivu 309)

Varaosat (katso sivu 311)

Suomi Tekniset tiedot

Häiriö	Syy	Toimenpide
Ei toimintoa	- ei jännitettä - Perussarjan muuntaja epäkunnossa - Vastaanotin huonossa paikassa / epäkunnossa - Lähetintä ei opetettu / lähetin epäkunnossa	- Varmista tehonsaanti - Muuntaja vaihdetaan - Vastaanottajan paikka vaihdetaan tai vastaanot- taja vaihdetaan - Lähetin opetetaan / vaihdetaan
Käyttätilaa ei voi konfiguroida	- Kielikosketin ei sopivassa paikassa renkaan takana - Kielikosketin viallinen	- Kielikosketin laitetaan renkaaseen - Liitäntäjohdon magneettiventtiili vaihdetaan
Ei valotoimintoa	- Rainmaker-muuntajaa ei liitetty / muuntaja epä- kunnossa - Valoreleen tulojohdot viallisia / rikki	- Muuntajan tehonsaanti varmistetaan / muuntaja vaihdetaan - Liitokset ja valorele tarkistetaan / vaihdetaan
Käyttölaitteet kytkeytyvät pois automaattisesti	- Toiminta-aika tallennettu ohjelmatilaan	- Huoltoilman jälkikäyntiaika pidennetään / kytke- tään pois
Hana epätiivis	- Magneettiventtiili likainen / rikki	- Magneettiventtiilin kalvot puhdistetaan / vaih- detaan
Liian pieni läpivirtaus	- Tulopuolen likasuodatin likainen	- Puhdista / vaihda likasihti

Tunnukset

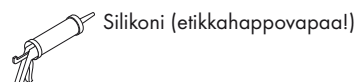
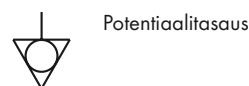
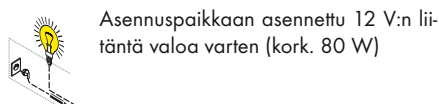
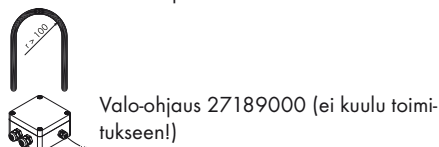
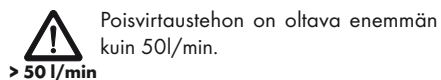
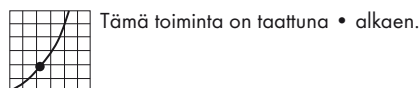
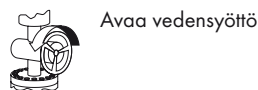
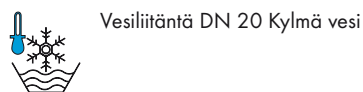
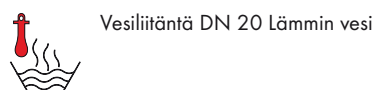

Asennus katso sivu 303

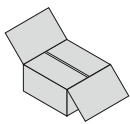

Suomi Varusteet

Muuntaja:

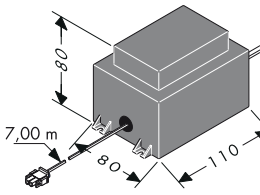

Ulkoisen muuntajan teho on 50 VA. Muuntaja on asennettava kuivaan paikkaan (suoja-alue 3). Muuntajan voi asentaa yhdessä vastaanottimen kanssa muovikoteloon EN/IEC 60335-1:n mukaisesti. ((mitat n. 250 x 160 x 92 mm), ei kuulu toimitukseen.) Mukana toimitettu kaapeli mahdollistaa muuntajan asentamisen 7,00 m etäisyydelle vastaanottimesta. Tällöin on käytettävä suojusputkea EN35 (ei kuulu toimitukseen) Suojusputki on kiinnitettävä vähintään 500 mm välein ja taivutussäteen tulee olla yli 100 mm.

Muuntajan n. 7,00 m pituista sekundäärijohtoa ei saa lyhentää. Tarpeeton johtomäärä on sijoitettava turvamuuntajan läheisyyteen. Vahingoittunutta liitäntäjohtoa ei saa korvata toisella. Muuntajaa

ei saa enää käyttää.

Vahingoittunutta liitäntäjohtoa ei saa korvata toisella. Verkko-liitäntäjohdon ollessa viallinen sähköalan ammattilaisen täytyy vaihtaa johto sekä muuntaja.

Valorele:

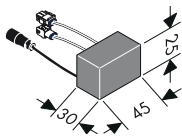

(vain integroidun valon kanssa toimivissa versioissa)

Valorelettä saa kuormittaa maks. 12 V AC / 80 W. Käyttö 230 V -verkossa ei ole sallittua.

Valo-ohjaus:

27189000

(ei kuulu toimitukseen)

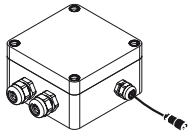

(iControl mobile 15944000)

Valo-ohjaus on liitettävä ulkoisia valolähteitä käytettäessä.

Valo-ohjaukseen täytyy aina päästä käsiksi.

Ohjelmointipistoke:

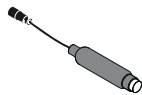

(Raindance Rainfall 28411000 / Raindance Rainmaker 28403000)

Ohjelmointipistoke pitää liittää ilman valoa toimivaan malliin.

Kun huolto-moodi aktivoidaan ilman valoa toimivassa mallissa, ohjelmointipistokkeen valodiodi ilmaisee optiset vastaussignaalit.

Koodauspistokkeeseen täytyy aina päästä käsiksi.

Liitäntäjohto Magneettiventtiililohko / Liitäntäjohto valo:



Magneettiventtiililohkon 7,50 m pituista johtoa ja 10,00 m pituista valojohtoa ei saa lyhentää. Tarpeeton johtomäärä on sijoitettava vastaanottimen läheisyyteen.

Magneettiventtiililohkon johdon ja valojohton saa asentaa vain mukana toimitettuun suoja-putkeen (EN 20).

Suojusputki on kiinnitettävä vähintään 500 mm välein ja taivutussäteen tulee olla yli 100 mm.

Huomio: Magneettiventtiililohkon johdon ja valojohton suoja-putkiin ei saa asentaa sähköjohtoja, joiden jännite on yli 12V.

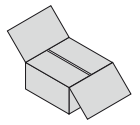

Vastaanotin:

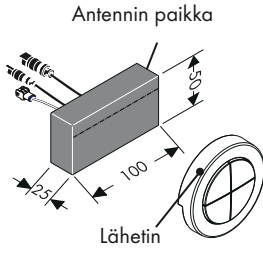

Vastaanotin tulee asentaa samaan tilaan suihkulaiteiston kanssa.

Jos tämä ei ole mahdollista, vastaanottimen voi asentaa suihkutilan viereiseen tilaan.

Vastaanotinta ei saa asentaa metallikoteloon, koska tällöin lähettimen radiosignaalit eivät pääse vastaanottimeen. Lisäksi on huomioitava, että vastaanottimen asennuspaikan läheisyydessä on mahdollisimman vähän radioaaltojen kulkua estäviä metalliosia.

Vastaanottimen antenni on suunnattava läh-

timeen radiosignaalien optimaalista vastaanottamista varten.

Lähetin:



Vastaanotin on jo toimitettaessa oppinut/tallentanut lähettimen. Lähetin ja siihen kuuluva vastaanotin voidaan tunnistaa saman sarjanumerin perusteella.

Lisä- tai myöhemmin hankitut lähetimet on opittava tunnistamaan. Maks. 4 lähetintä voidaan oppia ja/tai tallentaa. (katso sivu 150/151 Kirjautumistila).

Lähettimen radiotaajuus on 868,3 MHz.

Huomautus: Vastaanottimen ja lähettimen kantama on n. 10,00 m. Kantama riippuu siitä, mitenkä voimakkaasti radiosignaalit vaimenevat vastaanottimen ja lähettimen välillä.

Huomautus: Lähetintä käytetään turvallisuussyistä vain suihkujärjestelmän näköetäisyydellä. Muuten vedentulon voi käynnistää erehdyksessä.

Huomautus: Oikea toimintatapa vaihdettaessa rikkinäinen lähetin uuteen lähettimeen.

1. Pyyhi muistista pois kaikki opitut lähetimet. (Kirjautumistila ⇒ Pyyhi muistista -moodi.).
2. Opettele uudelleen kaikki muut lähetimet paitsi rikkinäinen lähetin. (Service-moodi ⇒ Kirjautumistila).

Materiaali	Vaimennus
Puu, kipsi, lasi (päällystämätön, ilman metallia)	0 - 10 %
Tiili, prespaanilevy	5 - 35 %
Raudoitettu betoni	10 - 90 %
Metalli, alumiinikerros	90 - 100 %

Magneetti:



Huoltotilan aktivoimiseksi magneetin täytyy painaa kielikosketinta (renkaan takana). (katso sivu 148/149, Service-moodi).

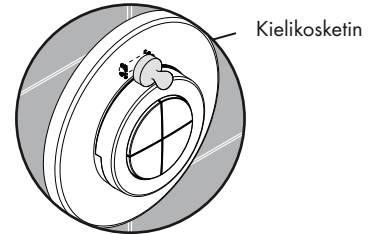

Raindance Rainfall

28411000

iControl mobile

15940180 / 15942000

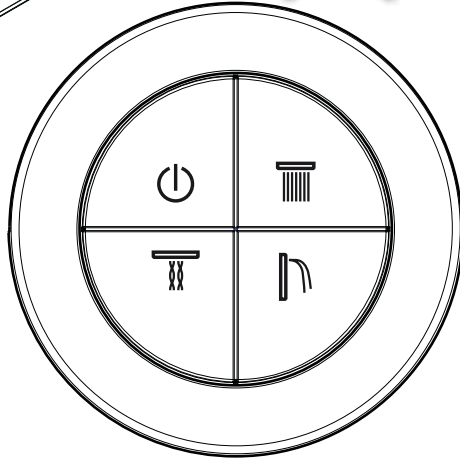
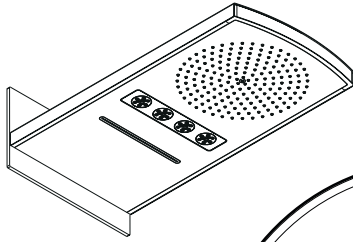

Raindance Rainfall

28411000

iControl mobile

15941180 / 15944000

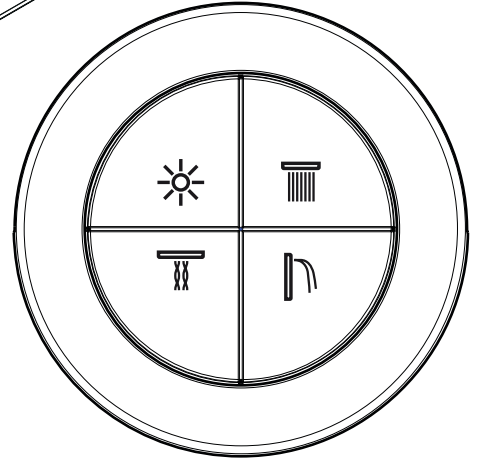
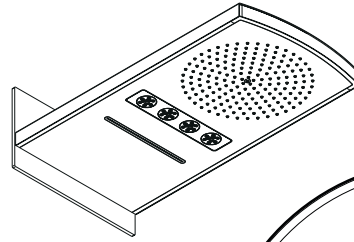

Raindance Rainmaker

28403000

iControl mobile

15940180 / 15943000

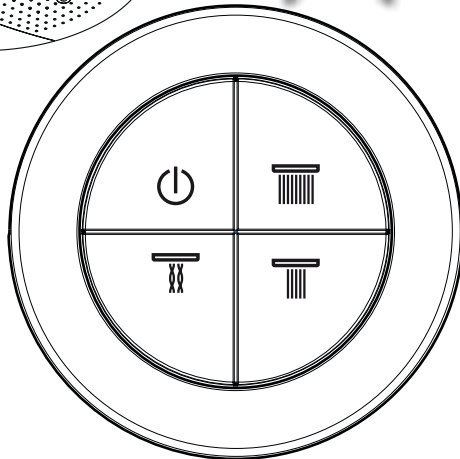
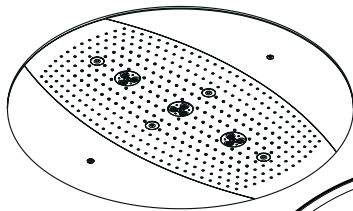

Raindance Rainmaker

28404000

iControl mobile

15941180 / 15945000

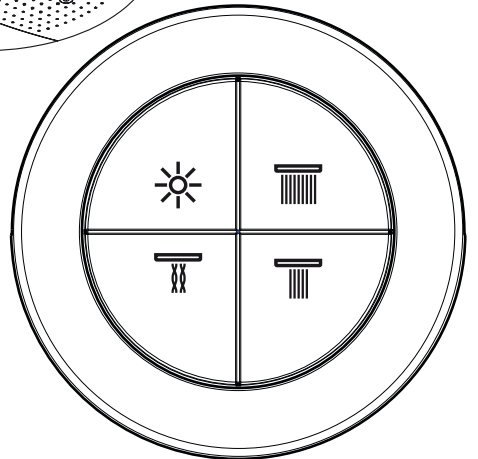
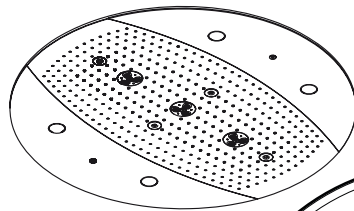

kaikki pois



Rain



Whirl



Rainflow



valo



Rain AIR XXL



Rain AIR

Asennus katso sivu 303

Suihkujen ja valon päälle- ja poiskytkentä:

(Vakiotoiminta valolla)

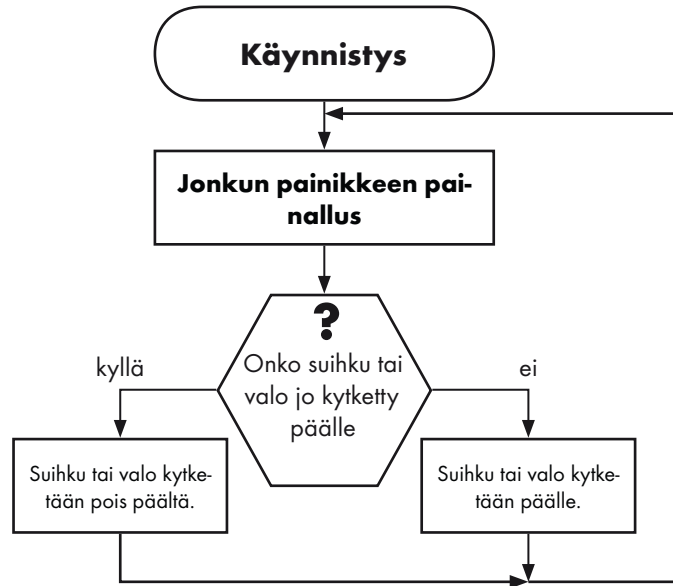

Suihkujen päälle- ja poiskytkentä:

(Vakiotoiminta ilman valoa)

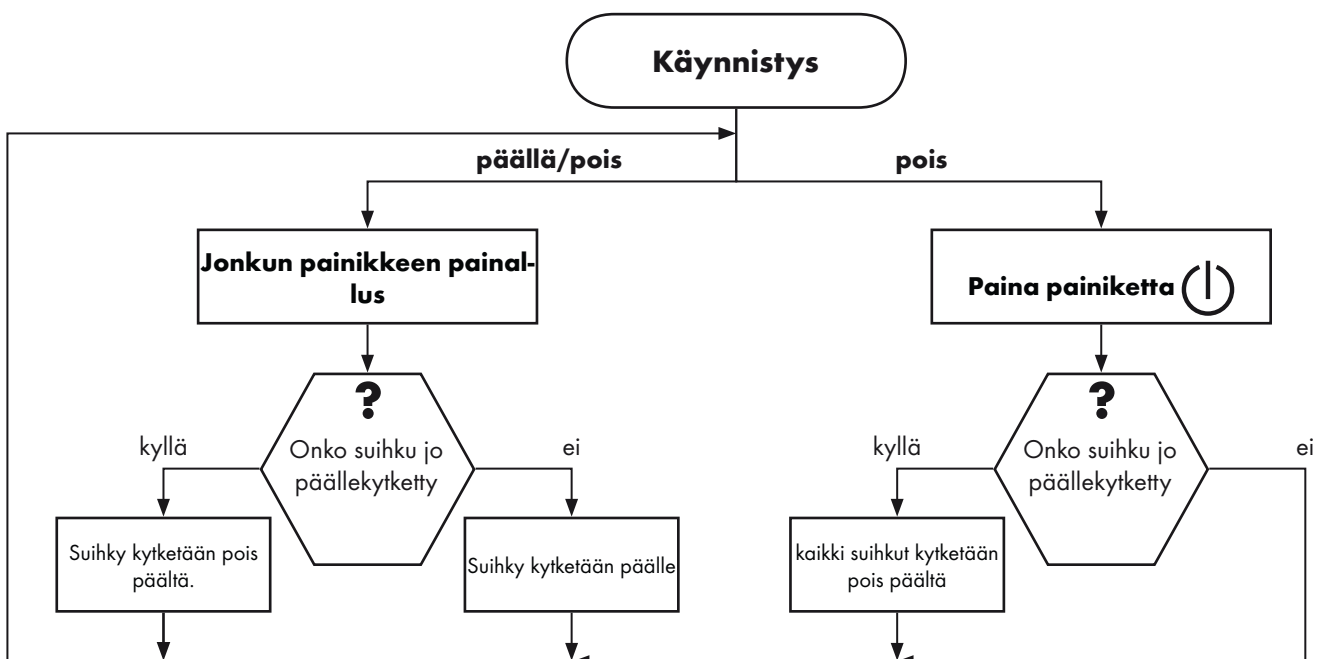

Suomi Käyttäjätaso

Raindance Rainfall
28411000

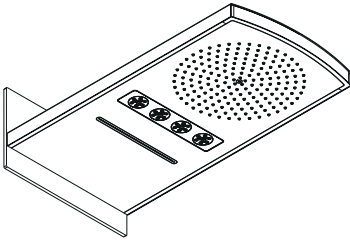

Käyttömoodi

Huomautus:
Kaikkien suihkujen tulee olla
päällekytkettynä



Service-moodi

Huomautus:
Valo / ohjelmointipistoke
vilkkuu 4 x

Huomautus:
Valo / ohjelmointipistoke
sammuu

Huomautus:
Valo / ohjelmointipistoke
vilkkuu 2 x

< 15 sek.

> 15 sek.

Paina  **tai** 
painiketta 2 x

Paina  **painiketta 2x**

**Maksimitoiminta-aika-
moodi**

Huomautus:
Valo / ohjelmointipistoke
vilkkuu 1 sek. Välein

Suihku-moodi



Huomautus:
Valo / ohjelmointipistoke
vilkkuu 2 sek. Välein

< 15 sek.

> 15 sek.

< 15 sek.

> 15 sek.

Paina  **tai** 
painiketta

Paina  **pai-
niketta**

Paina  **pai-
niketta**

Paina  **pai-
niketta**

Paina  **tai** 
painiketta

Paina  **pai-
niketta**

Toiminta-ajat:
Suihkut: 30 s
valo: 30 min

Standart:
Suihkut: 60 s
valo: 30 min

**Toiminta-
ajat:**
Suihkut: 180 s
valo: 30 min

Toiminta-ajat:
Suihkut ja valo:
jatkuvasti

Standart
päälle voidaan
kytkeä maks. 2
suihkua

Komfort 1:
kaikki suihkut voi
kytkeä päälle
samanaikaisesti

Suomi Käyttäjätaso

Raindance Rainmaker
28403000 / 28404000

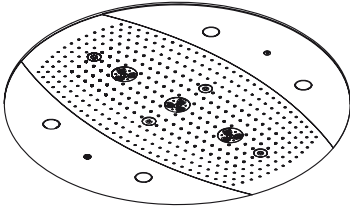

Käyttömoodi

Huomautus:
Kaikkien suihkujen tulee olla
päällekytkettynä



Service-moodi

Huomautus:
Valo / ohjelmointipistoke
vilkkuu 4 x

Huomautus:
Valo / ohjelmointipistoke
sammuu

Huomautus:
Valo / ohjelmointipistoke
vilkkuu 2 x

< 15 sek.

> 15 sek.

Paina  **tai** 
painiketta 2 x

Paina painiketta 2x

**Maksimitoiminta-aika-
moodi**

Huomautus:
Valo / ohjelmointipistoke
vilkkuu 1 sek. Välein

Suihku-moodi



Huomautus:
Valo / ohjelmointipistoke
vilkkuu 2 sek. Välein

< 15 sek.

> 15 sek.

< 15 sek.

> 15 sek.

Paina  **tai** 
painiketta

Paina painiketta

Paina painiketta

Paina painiketta

Paina  **tai** 
painiketta

Paina painiketta

Paina painiketta

Toiminta-ajat:
Suihkut: 30 s
valo: 30 min

Standart:
Toiminta-ajat:
Suihkut: 60 s
valo: 30 min

**Toiminta-
ajat:**
Suihkut: 180 s
valo: 30 min

Toiminta-ajat:
Suihkut ja valo:
jatkuvasti

Standart
päälle voidaan
kytkeä maks. 2
suihkua

Komfort 1:
kaikki suihkut voi
kytkeä päälle
samanaikaisesti

Komfort 2:
Suurempi vesi-
määrä, tarpeen
vain Rainmaker:
issa

Suomi Asiatuntijataso

Raindance Rainfall
28411000

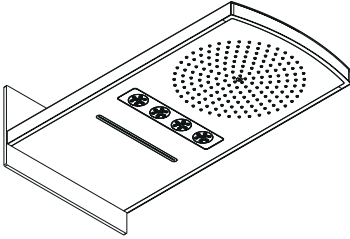

Käyttömoodi

Huomautus:
Kaikkien suihkujen tulee olla
päällekytkettynä



Service-moodi
Huomautus:
Valo / ohjelmointipistoke
vilkkuu 4 x

Huomautus:
Valo / ohjelmointipistoke
vilkkuu 2 x

Huomautus:
Valo / ohjelmointipistoke
sammuu

< 15 sek.

> 15 sek.

**Paina jotakin painiketta
1x**

Paina painiketta 2x

Paina painiketta 2x

Kirjautumistila

Pyyhi muistista -moodi.
Huomautus:
Valo / ohjelmointipistoke
vilkkuu 0,5 sek. Välein

Esittely-moodi
Huomautus:
Valo / ohjelmointipistoke
vilkkuu 4 sek. Välein

kyllä
ei
?
Onko lähetin
tunnettu

kyllä
ei
?
Tunnettujen lähettimien
lukumäärä? ≤
3 kappaletta

Huomautus:
Valo / ohjel-
mointipistoke
vilkkuu 1 x

Huomautus:
vanhin tunnettu
lähetin poiste-
taan muistista

Huomautus:
Valo / ohjelmointipisto-
ke vilkkuu 3 x
uusi lähetin opitaan ja tallenne-
taan

< 15 sek.

> 15 sek.

< 15 sek.

> 15 sek.

Paina **tai** **painiketta**

kaikki lähetti-
met pyyhitään
muistista

Paina **pai-
niketta**

käytössä oleva
lähetin pyyhi-
tään muistista

Paina **tai** **pai-
niketta**

Esitys 1 käyn-
nistetään

Paina **pai-
niketta**

Esitys 2 käyn-
nistetään

Paina **pai-
niketta**

Esitys 3 käyn-
nistetään

Jonkun painikkeen painallus
Huomautus:
kaikki suihkut sulkeutuvat

Suomi Asiatuntijataso

Raindance Rainmaker
28403000 / 28404000

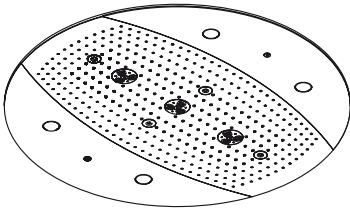

Käyttömoodi

Huomautus:
Kaikkien suihkujen tulee olla
päällekytkettynä



**Käytä REED-
kytkintä
magneetin
avulla**

Service-moodi
Huomautus:
Valo / ohjelmointipistoke
vilkkuu 4 x

Huomautus:
Valo / ohjelmointipistoke
vilkkuu 2 x

Huomautus:
Valo / ohjelmointipistoke
sammuu

< 15 sek.

> 15 sek.

**Paina jotakin painiketta
1x**

Paina painiketta 2x

Paina painiketta 2x

Kirjautumistila

Pyyhi muistista -moodi.
Huomautus:
Valo / ohjelmointipistoke
vilkkuu 0,5 sek. Välein

Esittely-moodi
Huomautus:
Valo / ohjelmointipistoke
vilkkuu 4 sek. Välein

?
Onko lähetin
tunnettu

kyllä

ei

?
Tunnettujen lähettimien
lukumäärä ≤
3 kappaletta

kyllä

ei

Huomautus:
Valo / ohjel-
mointipistoke
vilkkuu 1 x

Huomautus:
vanhin tunnettu
lähetin poiste-
taan muistista

Huomautus:
Valo / ohjelmointipisto-
ke vilkkuu 3 x
uusi lähetin opitaan ja tallenne-
taan

< 15 sek.

> 15 sek.

< 15 sek.

> 15 sek.

Paina **tai** **painiketta**

kaikki lähetti-
met pyyhitään
muistista

Paina **pai-
niketta**

käytössä oleva
lähetin pyyhi-
tään muistista

Paina **tai** **pai-
niketta**

Esitys 1 käyn-
nistetään

Paina **pai-
niketta**

Esitys 2 käyn-
nistetään

Paina **pai-
niketta**

Esitys 3 käyn-
nistetään

Jonkun painikkeen painallus
Huomautus:
kaikki suihkut sulkeutuvat

Normer och riktlinjer:

Följande riktlinjer gäller för användningen av produkten:

- EN 15200
- EN 60335-2-105



Säkerhetsanvisningar:

- Produkten får bara användas till kroppshygien med bad och dusch.
- Barn får inte använda duschsystemet ensamma.
- Barn samt vuxna med fysiska, psykiska eller sensoriska funktionshinder får inte använda duschsystemet ensamma. Personer som är påverkade av alkohol- eller droger får inte använda duschsystemet.
- Undvik att rikta duschstrålarna mot känsliga kroppsdelar (t. ex. ögonen). Det måste finnas ett tillräckligt stort avstånd mellan duschen och kroppen.
- Stora tryckskillnader mellan anslutningarna för varmt och kallt vatten måste utjämnas.



Elektrisk anslutning:

- Installations- och kontrollarbeten ska utföras av behörig elektroinstallatör, enligt VDE 0100 del 701 o. IEC 60364-7-701.
- Det behövs bara ett eluttag för elanslutningen. Strömförsörjningen löper över en extern transformator.
- Det får inte finnas lättantändligt material i direkt närhet.
- Den omgivande temperaturen får inte överstiga 50 °C.
- Huvudströmförsörjningen löper över en 230V/N/PE/50Hz växelströmsanslutning.
- Säkringarna måste ske via en felströms-skyddsanordning (RCD/FI)
- med en differensström på ≤ 30 mA.
- Om en potentialutjämning behövs ska detta ordnas på användningsplatsen.
- Vid elinstallationen ska gällande föreskrifter från VDE [branchorganisation Verband der Elektrotechnik, Elektronik und Informationstechnik e.V. Bestimmungen], land- och EVU [elbolag- Elektrizitätsversorgungsunternehmen] i aktuell utgåva följas.
- Det måste finnas möjlighet att skilja produkten från elnätet. Aningen med en fritt åtkomlig stickkontakt eller med en allpolig strömbrytare enligt EN 60335-1 avs. 24.3.



Montering: (se sidan 303)

- OBS! Armaturen måste installeras, genomspolas och testas enligt gällande föreskrifter. (Installation enligt EN 1717)
Se monteringsbeskrivning:
Raindance Rainfall 28411000
Raindance Rainmaker 28403000 / 28404000 / 28417000 / 28418000
- Samtliga arbeten får bara utföras när strömmen är avstängd.
- Basenheten 15941180 kan bara monteras lodrätt!
Montering med justeringsring (A) endast möjlig i det främre och mellersta området!
- Alla komponenter måste förbli tillgängliga.

Tekniska data:

Driftstryck::	max. 1 MPa
Rek. driftstryck:	0,1 - 0,5 MPa
Tryck vid provtryckning::	1,6 MPa
(1 MPa = 10 bar = 147 PSI)	
Varmvattentemperatur::	max. 80 ° C
Rek. varmvattentemp.:	65 ° C
Anslutningsmått:	G 3/4
Anslutningar Inflöde:	Blandvatten
Fri genomströmning vid 0,3 MPa:	
1 Förbrukare:	35 l/min
2 Förbrukare:	45 l/min



Tillbehör: (se sidan 154)



Måtten: (se sidan 292)



Monteringsexempel Raindance Rainfall: (se sidan 295)



Monteringsexempel Raindance Rainmaker: (se sidan 299)



Hantering: (se sidan 156)

- Vid ett strömavbrott i 230 V nätspänningen kan duschenheten inte användas.
- Produkten är inte avsedd att användas tillsammans med ett ångbad!































Rengöring Filter: (se sidan 309)

Atsarginés dalys (se sidan 311)

Svenska Teknisk information

Störning	Orsak	Åtgärd
Ingen funktion	- Ingen spänningsförsörjning - Transformator till grundset defekt - Mottagare olämpligt placerad / defekt - Sändare inte inlagd / defekt	- Säkerställ spänningsförsörjning - Byt transformator - Ändra mottagarposition eller byt ut mottagare - Lägg in / byt ut sändare
Det går inte att ställa in driftsläge	- Reed-kontakt inte på rätt plats bakom rosetten - Reed-kontakt felaktig	- Placera Reed-kontakt vid rosetten - Byt anslutningsledning till magnetventil
Inget ljus	- Transformator Rainmaker inte ansluten / felaktig - Inkommande ledningar ljusrelän felaktiga / defekta	- Säkerställ spänningsförsörjning till transformator / byt ut transformator - Kontrollera / byt ut kopplingar och ljusrelän
Förbrukare stänger av sig självständigt	- Arbetsintervall sparad i programläge	- Förläng / stäng av fördröjningstiden i service-läget
Otät blandare	- Magnetventil smutsig/defekt	- Rengör / byt ut magnetventilmembran
För litet genomflöde	- Smutsfilter på ingångssidan smutsigt	- Rengör / byt ut smutsfilter

Symboler

	Vattenanslutning DN 20 Varmvatten		Transformator		Potentialutjämning
	Vattenanslutning DN 20 Kallvatten		Mottagare		Allt avstängt.
	Slå på vatten		Kodningskontakt		Ljus
	Stäng av vattnet		230V		Rain
	Från • garanteras funktionen.		12V		Whirl
	Avloppet måste klara mer än 50 l/min. > 50 l/min		Ihålligt rör		Rainflow
	Avlopp		Ljusstyrning 27189000 (ingår ej i leveransen!)		Rain AIR XXL
	Raindrain		Ljusrelä Rainmaker		Rain AIR
	Mitten av duschkaret		Transformator Rainmaker		Silikon (fri från ättiksyra!)
			12 V-anslutning för ljus (max. 80 W) ska installeras på användningsplatsen		

Montering se sidan 303

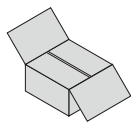

Svenska Tillbehör

Transformator:

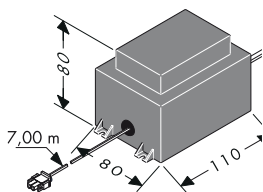

Effekten hos den externa transformatorn uppgår till 50 VA. Transformatorn måste installeras i den torra delen (skyddszon 3). Transformatorn kan monteras i ett plasthus tillsammans med mottagaren, enligt EN/IEC 60335-1. (mått ca 250 x 160 x 92 mm, medföljer inte leveransen.) Den medföljande kabeln gör det möjligt att installera transformatorn upp till 7,00 m bort från mottagaren. Till detta måste det finnas ett tomt kabelrör EN35 (medföljer inte leveransen). Det tomma kabelröret måste fixeras minst var 500:de mm och svänggradien måste vara större än 100 mm.

Den ca 7,00 m långa sekundärkabeln till transformatorn får inte kortas. Den kabel som inte behövs ska förvaras i närheten av säkerhets-transformatorn.

En skadad anslutningskabel får inte bytas ut. Transformatorn får då inte användas mer.

En skadad anslutningskabel får inte bytas ut. När en nätkabel är defekt måste både kabeln och transformatorn bytas ut av en elfackman.

Ljusrelä:

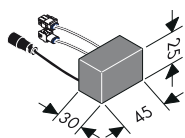

(gäller endast modeller med integrerat ljus)

Ljusrelät får maximalt belastas med 12 V AC / 80 W.

Det är inte tillåtet att använda det i 230 V nätet.

Ljusstyrning:

27189000

(medföljer ej leveransen)

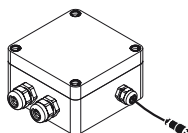

(iControl mobile 15944000)

Ljusstyrningen måste anslutas på varianterna med extern ljuskälla.

Ljusstyrningen måste alltid vara tillgänglig.

Kodningskontakt:

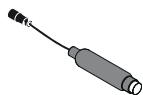

(Raindance Rainfall 28411000 / Raindance Rainmaker 28403000)

Kodningskontakten måste anslutas på modellerna utan ljus.

Om serviceläget är aktiverat på modellerna utan utan ljus visar kodningskontaktens lysdiod de optiska svarssignalerna.

Kodningskontakten måste alltid vara tillgänglig

Anslutningskabel Magnetventilblock / Anslutningskabel Ljus:



Den 7,50 m långa kabeln till magnetventilblocket samt den 10,00 m långa ljuskabeln får inte kortas. Den kabelmängd som inte behövs ska förvaras i närheten av mottagaren.

Kabeln till magnetventilblocket och ljuskabeln får bara dras i det medföljande tomma kabelröret (EN 20).

Det tomma kabelröret måste fixeras minst var 500:de mm och svänggradien måste vara större än 100 mm.

OBS: I de tomma kabelrören till magnetventilblock och ljuskablarna får inga elkablar med spänning högre än 12 V dras in.

Montering se sidan 303

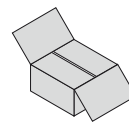

Mottagare:

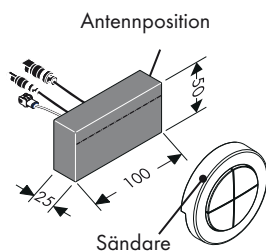

Mottagaren bör helst monteras i samma utrymme som duschenheten.

Om detta inte är möjligt kan mottagaren monteras i ett utrymme som gränsar till duschenheten.

Mottagaren får inte monteras i ett metallhus eftersom sändarens signaler då skulle skämmas av. Det är även viktigt att det finns så få avskärmande metalleder som möjligt på det ställe där mottagaren monteras.

Mottagarens antenn bör vara riktad mot sändaren om signalerna ska registreras på ett optimalt sätt.

Sändare:



Sändaren är redan inställd på mottagaren vid leveransen. Identiska serienummer gör att sändaren kan paras ihop med mottagaren.

Extra sändare, eller sändare som skaffas i efterhand, måste ställas in. Högst fyra sändare kan ställas in resp. sparas. (se sidan 160/161 Inloggningsläge).

Sändarens radiofrekvens är 868,3 MHz.

Hänvisning: Mottagare och sändare har en räckvidd på ca 10,00 m. Räckvidden styrs av i vilken omfattning signalerna mellan sändare och mottagare dämpas.

Hänvisning: Av säkerhetsskäl ska sändaren bara användas där man kan se den från duschsystemet. I annat fall kan vatten oavsiktligt slås på.

Hänvisning: Gör så här när en defekt sändare ska bytas ut mot en ny:

1. Radera alla sändare. (Inloggningsläge ⇒ Raderingsläge).
2. Lägg in alla sändare, utom den defekta, på nytt. (Serviceläge ⇒ Inloggningsläge).

Material	Dämpning
Trä, gips, glas (utan beläggning, utan metall)	0 - 10 %
Tegelsten, spånskivor	5 - 35 %
Betong med järnarmering	10 - 90 %
Metall, aluminiumlaminering	90 - 100 %

Magnet:



När serviceläget ska aktiveras måste magneten öppna REED-kontakten (bakom rosetten). (se sidan 158/159, Serviceläge).

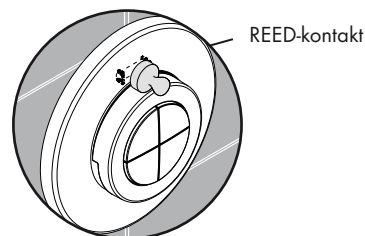

Raindance Rainfall

28411000

iControl mobile

15940180 / 15942000

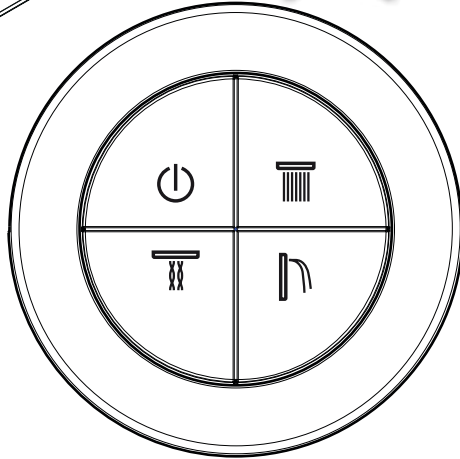
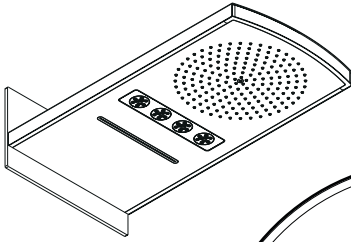

Raindance Rainfall

28411000

iControl mobile

15941180 / 15944000

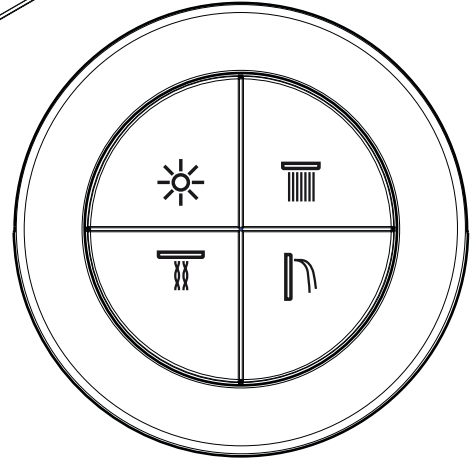
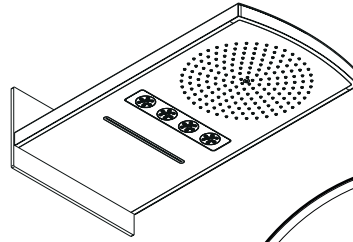

Raindance Rainmaker

28403000

iControl mobile

15940180 / 15943000

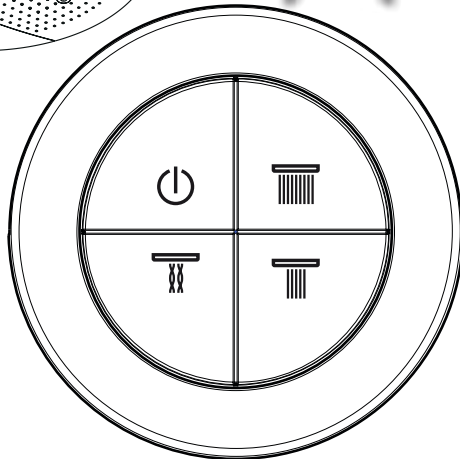
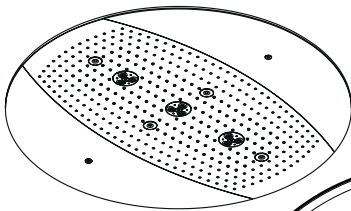

Raindance Rainmaker

28404000

iControl mobile

15941180 / 15945000

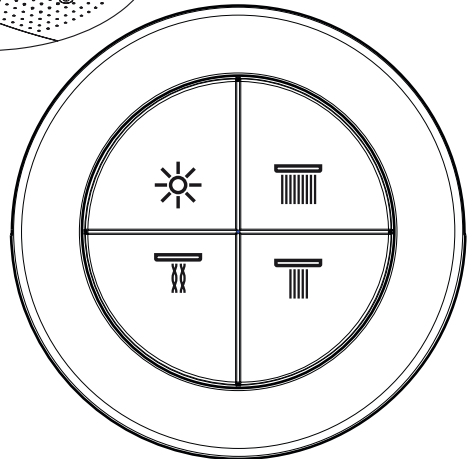
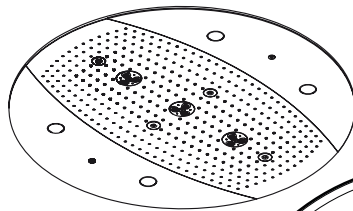

Allt avstängt.



Rain



Whirl



Rainflow



Ljus



Rain AIR XXL



Rain AIR

Montering se sidan 303

Starta och stänga av duschmunstycke samt slå på och av ljus:

(Standardfunktion med ljus)

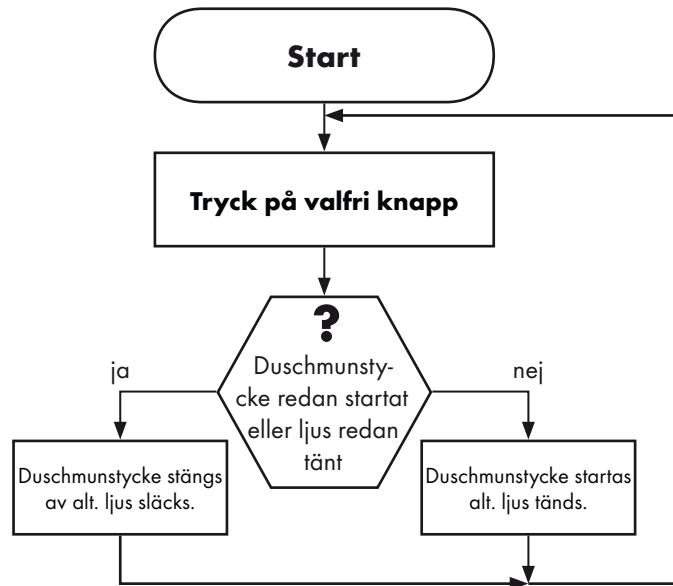

Starta och stänga av duschmunstycken:

(Standardfunktion utan ljus)

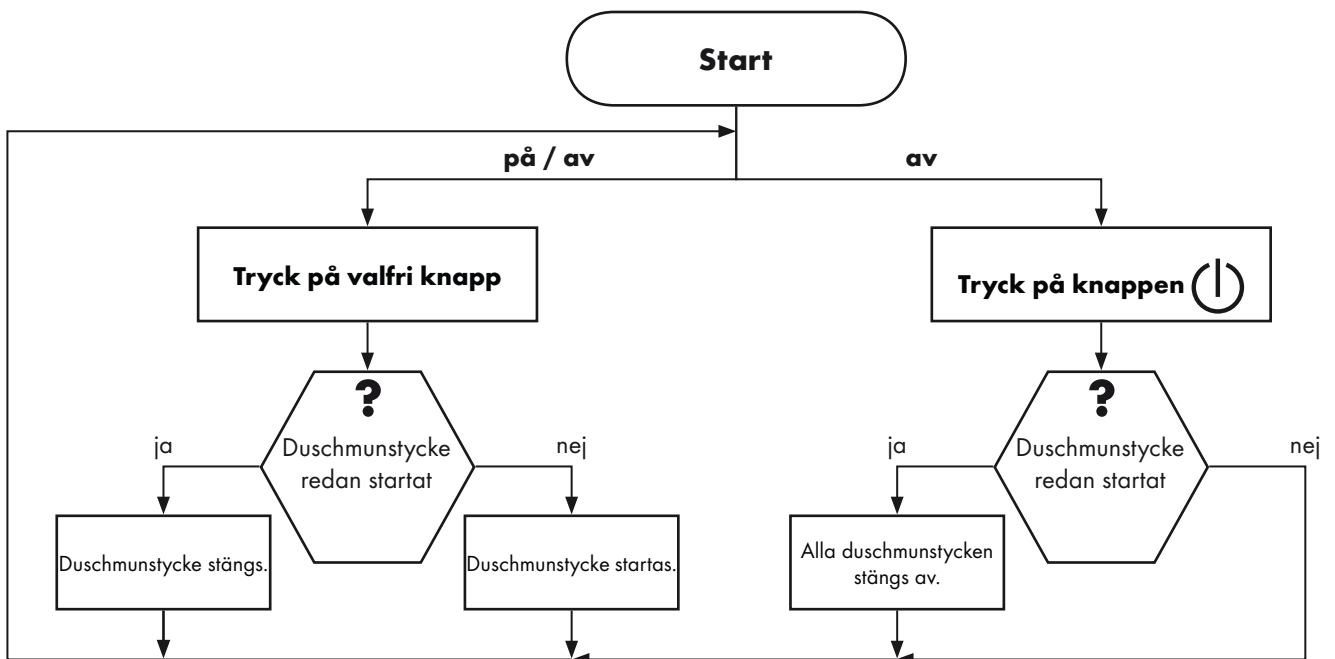

Svenska Användarnivå

Raindance Rainfall
28411000

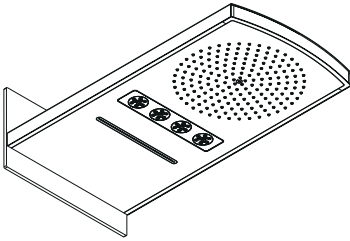

Användningsläge

Hänvisning:
Alla duschmunstycken
måste vara avstängda.



Service läge

Hänvisning:
Ljus / kodningskontakt
blinker fyra gånger

Hänvisning:
Ljus / kodningskontakt
blinker 2 gånger

Hänvisning:
Ljus slocknar / kodnings-
kontakt stängs av.

< 15 sek.

> 15 sek.

Tryck två gånger på
knappen  eller 

 Tryck två gånger
på knappen.

Maximaltidsläge

Hänvisning:
Ljus / kodningskontakt
blinker i en sek.-intervaller.

Duschläge

Hänvisning:
Ljus / kodningskontakt
blinker i 2 sek.-intervaller.

< 15 sek.

> 15 sek.

< 15 sek.

> 15 sek.

Tryck på
knapp 
eller 

 Tryck på
knappen

 Tryck på
knappen

 Tryck på
knappen

Tryck på
knapp 
eller 

 Tryck på
knappen

Intervaller:
Duschmunstycken: 30 s
Ljus: 30 min

Standard:
Intervaller:
Duschmunstycken: 60 s
Ljus: 30 min

Intervaller:
Duschmunstycken: 180 s
Ljus: 30 min

Intervaller:
Duschmunstycken + ljus:
oändligt

Standard
Max. två
munstycken kan
startas.

Komfort 1:
Alla duschmunstycken kan
startas samtidigt.

Svenska Användarnivå

Raindance Rainmaker
28403000 / 28404000

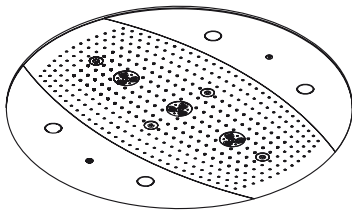

Användningsläge

Hänvisning:
Alla duschmunstycken
måste vara avstängda.



Service läge

Hänvisning:
Ljus / kodningskontakt
blinker fyra gånger

Hänvisning:
Ljus / kodningskontakt
blinker 2 gånger

Hänvisning:
Ljus slocknar / kodnings-
kontakt stängs av.

< 15 sek.

> 15 sek.

Tryck två gånger på
knappen  eller 

 Tryck två gånger
på knappen.

Maximaltidsläge
Hänvisning:
Ljus / kodningskontakt
blinker i en sek.-intervaller.

Duschläge
Hänvisning:
Ljus / kodningskontakt
blinker i 2 sek.-intervaller.

< 15 sek.

> 15 sek.

< 15 sek.

> 15 sek.

Tryck på
knapp 
eller 

 Tryck på
knappen

 Tryck på
knappen

 Tryck på
knappen

Tryck på
knapp 
eller 

 Tryck på
knappen

 Tryck på
knappen

Intervaller:
Duschmunstycken: 30 s
Ljus: 30 min

Standard:
Intervaller:
Duschmunstycken: 60 s
Ljus: 30 min

Intervaller:
Duschmunstycken: 180 s
Ljus: 30 min

Intervaller:
Duschmunstycken + ljus:
oändligt

Standard
Max. två
munstycken kan
startas.

Komfort 1:
Alla duschmunstycken kan
startas samtidigt.

Komfort 2:
Större vattenmängd,
behövs bar till
Rainmaker

Svenska Expertnivå

Raindance Rainfall
28411000

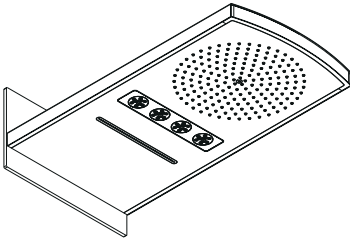

Användningsläge

Hänvisning:
Alla duschmunstycken
måste vara avstängda.



Serviceläge

Hänvisning:
Ljus / kodningskontakt
blinker fyra gånger

Hänvisning:
Ljus / kodningskontakt
blinker 2 gånger

Hänvisning:
Ljus slocknar / kodnings-
kontakt stängs av.

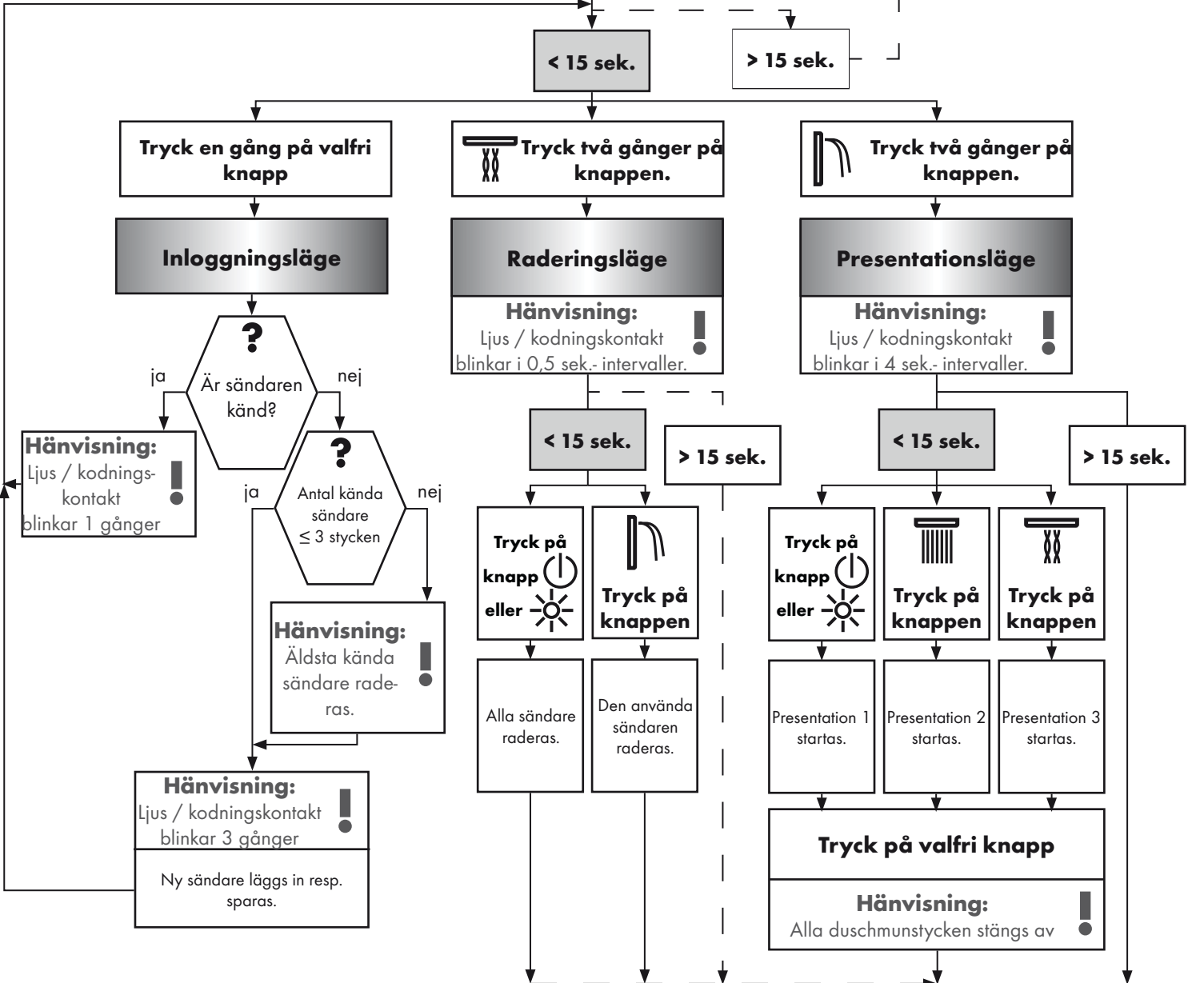

Svenska Expertnivå

Raindance Rainmaker
28403000 / 28404000

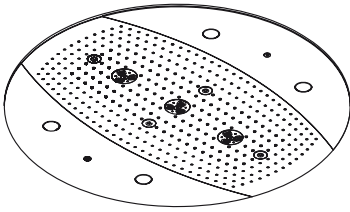

Användningsläge

Hänvisning:
Alla duschmunstycken
måste vara avstängda.



Serviceläge

Hänvisning:
Ljus / kodningskontakt
blinker fyra gånger

Hänvisning:
Ljus / kodningskontakt
blinker 2 gånger

Hänvisning:
Ljus slocknar / kodnings-
kontakt stängs av.

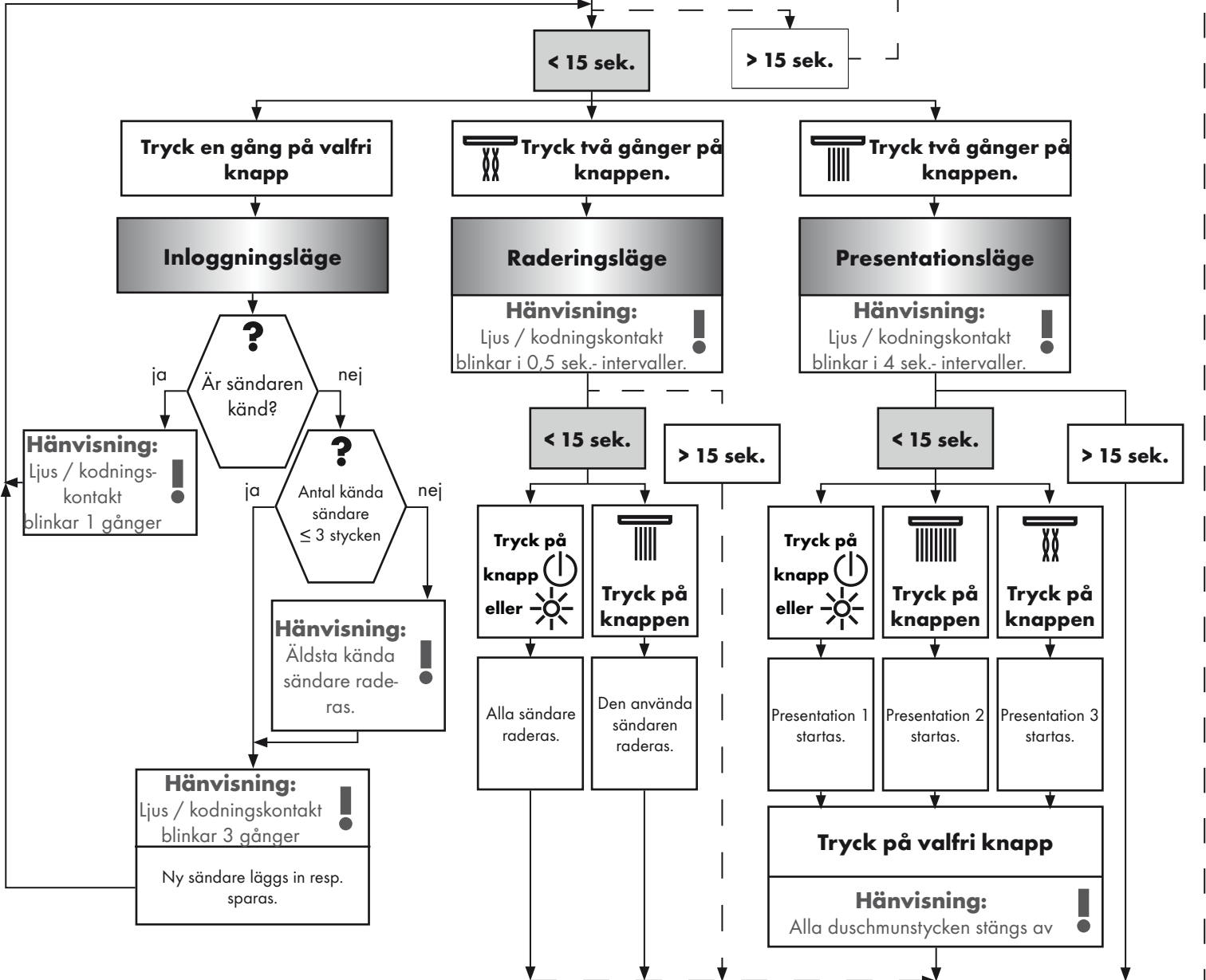

Normos ir direktyvos:

Gaminio naudojimas grindžiamas tokiomis direktyvomis

- EN 15200
- EN 60335-2-105



Saugumo technikos nurodymai:

- Gaminys turi būti naudojamas tik maudymuisi, kūno higienai ir švarai palaikyti.
- Vaikai neturi naudotis dušo sistema be suaugusiųjų priežiūros.
- Dušo sistema uždrausta naudotis vaikams, taip pat suaugusiems su fizine, dvasine negale ir (arba) sensorikos sutrikimais. Dušo sistema taip pat uždrausta naudotis asmenims, apsvaigusiems nuo alkoholio arba narkotikų.
- Būtina vengti dušo vandens srovės kontakto su jautriomis kūno vietomis (pvz., akimis). Todėl būtina laikytis tinkamo atstumo nuo dušo.
- Turi būti išlyginti šalto ir karšto slėgio nelygumai.



Elektros prijungimas:

- Instaliavimo ir tikrinimo darbus gali atlikti tik kvalifikuoti elektrikai pagal VDE 0100, 701 d. ir IEC 60364-7-701 standartų reikalavimus
- Elektrai prijungti reikalingas tik vienas kištukinis lizdas. Elektra tiekama per išorinį transformatorių.
- Netoli prietaiso negali būti jokių lengvai užsidegančių medžiagų.
- Aplinkos temperatūra negali viršyti 50 °C.
- Bendras elektros tiekimas vyksta per 230V/N/PE/50Hz kintamos srovės prievadą
- Apsauginis įrenginys (RCD / FI) apsaugo nuo nebalanso srovės, kai srovių skirtumas ≤ 30 mA .
- Jei reikia suvienodinti potencialus, tai reikia atlikti montavimo vietoje.
- Montuodami elektros įrangą, laikykitės galiojančių Vokietijos elektrotechnikos asociacijos (VDE), žemės ir - energijos tiekimo įmonės reikalavimų.
- Turi būti užtikrintas gaminio atjungimas nuo elektros tinklo. Tam naudojamas lengvai prieinamas kištukas arba daugiapolis jungiklis (EN 60335-1, 24.3 sk.)



Montavimas: (žr. psl. 303)

- Dėmesio! Maišytuvas privalo būti montuojamas ir išbandomas pagal veikiančias normas ir šią instrukciją. (Montavimas pagal EN 1717)
Žr. montavimo instrukciją:
Raindance Rainfall 28411000
Raindance Rainmaker 28403000 / 28404000 / 28417000 / 28418000
- Atlikdami bet kokius darbus, būtinai atjunkite maitinimo įtampą.
- Pagrindinė dalis 15941180 gali būti įstatyta tik vertikaliai! Reguliuojamą žiedą (A) montuojant galima naudoti tik priekinėje ir vidurinėje dalyje!
- Visos įrenginio dalys turi būti prieinamos.

Techniniai duomenys:

Darbinis slėgis::	ne daugiau kaip 1 MPa
Rekomenduojamas slėgis:	0,1 - 0,5 MPa
Bandomasis slėgis:	1,6 MPa
(1 MPa = 10 barų = 147 PSI)	
Karšto vandens temperatūra::	ne daugiau kaip 80 ° C
Rekomenduojama karšto vandens temperatūra:	65 ° C
Atstumas tarp centrų:	G 3/4
Prijungimas įvadas:	Nuotekos
Laisvas vandens pralaidumas esant 0,3 MPa slėgiui:	
1 Vartotojas:	35 l/min
2 Vartotojas:	45 l/min



Priedai: (žr. psl. 164)



Išmatavimai: (žr. psl. 292)



Montavimo pavyzdžiai Raindance Rainfall: (žr. psl. 295)



Montavimo pavyzdžiai Raindance Rainmaker: (žr. psl. 299)



Eksplotacija: (žr. psl. 166)

- Sutrikus 230 V tinklo įtampai, dušo įrenginiu naudotis negalima.
- Gaminis netinkamas naudoti garo pirtyje!































Valymas filtru: (žr. psl. 309)

Atsarginės dalys (žr. psl. 311)

Lietuviškai Techninė informacija

Gedimas	Priežastis	Priemonė
Jokios funkcijos	<ul style="list-style-type: none"> - netiekiami įtampa - Pažeista pagrindinio rinkinio jungė - Netinkama imtuvo padėtis arba jis pažeistas - Nesureguliuotas arba pažeistas siųstuvai 	<ul style="list-style-type: none"> - Įtampos tiekimo užtikrinimas - Pakeiskite transformatorių - Pakeiskite imtuvo padėtį arba jį patį - Sureguliuokite arba pakeiskite siųstuvą
Darbo režimas nekonfigūruojamas	<ul style="list-style-type: none"> - Vamzdelio kontaktas netinkamoje vietoje už papuošimo elemento - Neteisingas vamzdelio kontaktas 	<ul style="list-style-type: none"> - Vamzdelio kontaktą pritvirtinkite prie puošimo elemento - Pakeiskite magnetinio vožtuvo prijungimo kabelį
Nėra apšvietimo funkcijos	<ul style="list-style-type: none"> - Neįstatyta arba neteisinga „lietučio“ jungė - Neteisingas arba pažeistas foto relės įvadas 	<ul style="list-style-type: none"> - Užtikrinkite transformatoriaus įtampos tiekimą arba pakeiskite transformatorių - Patikrinkite arba pakeiskite sujungimus ir foto relę
Vartotojas išjungia pats	<ul style="list-style-type: none"> - Veikimo laikas nustatytas programos režime 	<ul style="list-style-type: none"> - Apatarnavimo režimu pailginkite arba išjunkite delso periodą
Nesandari jungtis	<ul style="list-style-type: none"> - Užterštas arba pažeistas magnetinis vožtuvas 	<ul style="list-style-type: none"> - Išvalykite arba pakeiskite magnetinio vožtuvo membraną
Per mažas srautas	<ul style="list-style-type: none"> - Užteršta tinklinė nešvarumų gaudyklė iš padavimo pusės 	<ul style="list-style-type: none"> - Išvalykite arba pakeiskite filtrą.

Ženkliai

	Vandens prijungimas DN 20 Šiltas vanduo		Transformatorius		Potencialų išlyginimas
	Vandens prijungimas DN 20 Šaltas vanduo		Imtuvai		Viskas išjungta
	Įjunkite vandens tiekimą		Tik į tam tikrą lizdą tinkantis kištukas		Šviesa
	Išjungti vandens tiekimą		230V		Rain
	Nuo • funkcionavimas garantuotas		12V		Whirl
	Nutekėjimo našumas turi būti ne mažesnis 50 l/min		Tuščias vamzdelis		Rainflow
	Nutekėjimas		Šviesos reguliavimas 27189000 (nėra pridėdama!)		Rain AIR XXL
	Raindrain		Šviesos relė Rainmaker		Rain AIR
	Dušo padėklo centras		Transformatorius Rainmaker		Silikonas (be acto rūgšties!)
			Užsakovo įmontuotas apšvietimo (maks. 80 W) 12 V įvadas		

Montavimas žr. psl. 303

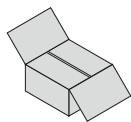

Lietuviškai Priedai

Transformatorius:

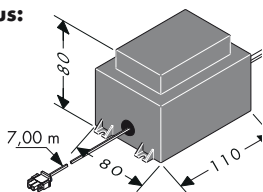

Išorinio transformatoriaus galia siekia 50 VA. Transformatorių įrenkite sausoje srityje (3 saugos zonoje). Transformatorių kartu su imtuvu galima įmontuoti į plastikinį korpusą, atsižvelgiant į EN / IEC 60335-1 reikalavimus. (apytikriai matmenys: 250 x 160 x 92 mm, neįeina į komplektaciją.) Komplektacijoje pristatomas kabelis leidžia įrengti transformatorių už 7,00 m nuo imtuvo. Tam tinklui turi būti numatytas tuščias vamzdis EN35 (neįeina į komplektaciją). Tuščią vamzdį būtina tvirtinti kas 500 mm, o išlinkimo spindulys turi būti didesnis nei 100 mm.

Maždaug 7,00 m ilgio transformatoriaus antrinio kabelio trumpinti negalima. Nepanaudotas kabelio ilgis yra laikomas šalia apsauginio

transformatoriaus. Pažeisto prijungimo kabelio negalima keisti. Tuo atveju transformatoriumi daugiau nebegalima naudotis.

Pažeisto prijungimo kabelio negalima keisti. Jeigu elektros tinklo jungties laidas turi defektą, jį ir transformatorių turi pakeisti kvalifikuotas elektrikas.

Šviesos relė:

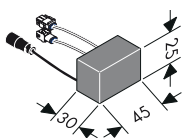

(tik jeigu yra integruotas apšvietimas)

Šviesos relė gali pakelti maksimalią 12 V AC / 80 W apkrovą.

Neleidžiama naudotis 230 V tinklo įtampa.

Šviesos reguliavimas:

27189000

(nėra pridama)

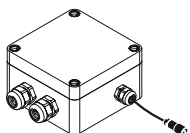

(iControl mobile 15944000)

Apšvietimo valdymas turi būti prijungiamas, jeigu naudojamas išorinis šviesos šaltinis. Apšvietimo valdymas turi būti visuomet prieinamas.

Tik į tam tikrą lizdą tinkantis kištukas:

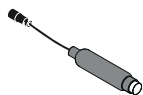

(Raindance Rainfall 28411000 /
Raindance Rainmaker 28403000)

Naudojant variantus be šviesos turi būti prijungtas tik į tam tikrą lizdą tinkantis kištukas.

Kai, naudojant variantus be šviesos, aktyvuojamas aptarnavimo režimas, tinkančio tik į tam tikrą lizdą kištuko šviesos diodas rodo optinius grįžtančius signalus.

Programuojamas kištukas turi būti nuolat prieinamas

Jungiamasis kabelis Magnetiniai vožtuvai / Jungiamasis kabelis Šviesa:



7,50 m ilgio magnetinių vožtuvų kabelio bei 10 m ilgio elektros kabelio negalima trumpinti. Nepanaudotas kabelio ilgis turi būti laikomas šalia imtuvo.

Magnetinių vožtuvų kabelį ir optinį kabelį galima nutiesti tik pristatomame tuščiam vamzdyje (EN 20).

Tuščią vamzdį būtina tvirtinti kas 500 mm, o išlinkimo spindulys turi būti didesnis nei 100 mm.

Dėmesio: Tuščiuose vamzdžiuose, skirtuose magnetinių vožtuvų kabeliams ir elektros laidams, negalima kloti elektros laidų, kuriais teka didesnė bei 12V įtampa.

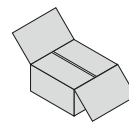

Imtuvas:

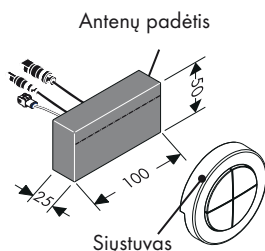

Imtuvą rekomenduojama montuoti toje pačioje patalpoje kaip ir dušo įrenginį. Jei tokios galimybės nėra, imtuvą galima sumontuoti ir kitoje patalpoje, kuri ribojasi su dušo įrenginiu. Imtuvo negalima įmontuoti į metalinį korpusą, kadangi taip slopinami siųstuvo radijo signalai. Be to, būtina atkreipti dėmesį ir į tai, kad netoli imtuvo sumontavimo vietos būtų kuo mažiau metalinių daiktų, kurie slopina radijo signalus.

Siekiant kaip galima geriau atpažinti radijo signalus, imtuvo anteną reikia nukreipti į siųstuvo pusę.

Siųstuvas:



Pristatant prekes, siųstuvas jau suderintas su imtuvu ir jį atpažįsta. Suteikti identiški serijų numeriai leidžia suporuoti siųstavą su imtuvu. Papildomi ar vėliau įsigyti siųstuvai turi būti užprogramuojami. Užprogramuoti ar įtraukti į atmintį galima daugiausiai 4 siųstuvus. (žr. psl. 170/171 Pranešimo režimas). Siųstuvo radijo bangų dažnis siekia 868,3 MHz

Nuoroda: Imtuvo ir siųstuvo veikimo zona siekia apie 10,00 m. Veikimo zona priklauso nuo to, kaip stipriai yra slopinami radijo signalai tarp siųstuvo ir imtuvo.

Nuoroda: Saugumo sumetimais siųstuvas naudojamas tik dušo sistemos matymo zonoje. Be to, tai turėtų apsaugoti nuo netyčinio vandens įjungimo.

Nuoroda: Teisingi veiksmai keičiant sugedusį siųstavą kitu nauju siųstavu.

1. ištrinti visus siųstuvus (Pranešimo režimas ⇒ Ištrinimas).
2. Visus siųstuvus, išskyrus sugedusį, užprogramuoti iš naujo. (Priežiūros mas ⇒ Pranešimo režimas).

Medžiaga	Slopinimas
Medis, gipsas, stiklas (nesluoksniuotas, be metalo)	0 - 10 %
Degintos plytos, presuotų drožlių plokštės	5 - 35 %
Betonas su geležine armatūra	10 - 90 %
Metalas, aliuminio folijos laminatas	90 - 100 %

Magnetas:



Techninio aptarnavimo režimui suaktyvinti turi būti įjungtas REED-kontakto magnetas (už lizdo) (žr. psl. 168/169, Priežiūros mas).

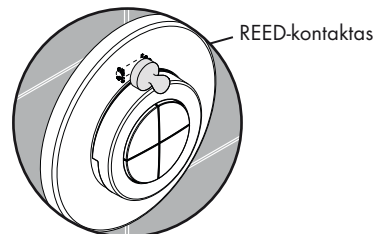

Raindance Rainfall

28411000

iControl mobile

15940180 / 15942000

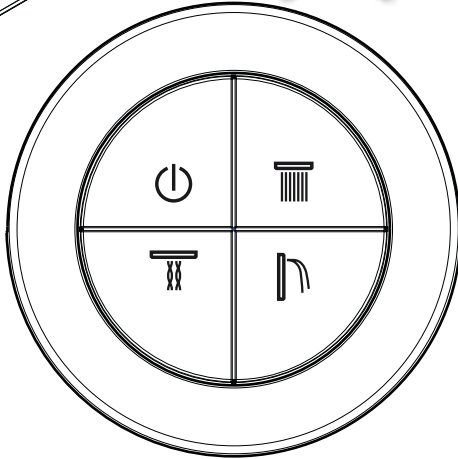
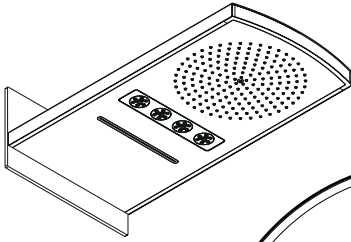

Raindance Rainfall

28411000

iControl mobile

15941180 / 15944000

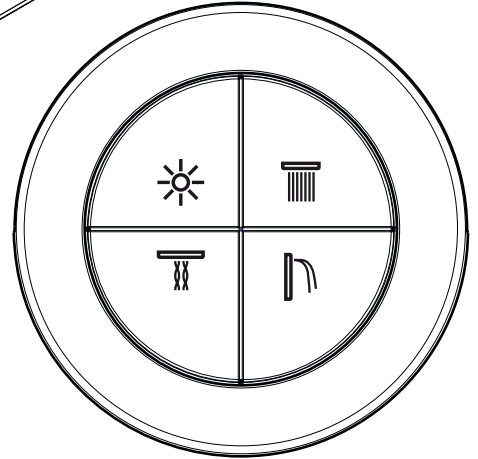
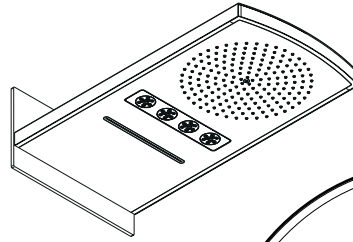

Raindance Rainmaker

28403000

iControl mobile

15940180 / 15943000

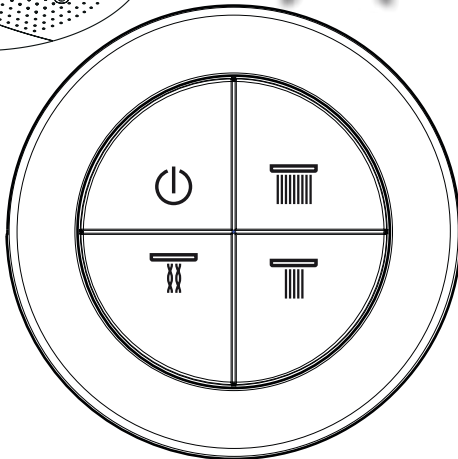
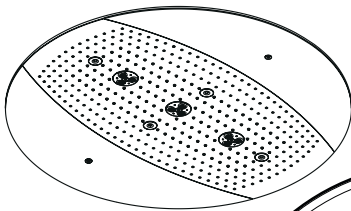

Raindance Rainmaker

28404000

iControl mobile

15941180 / 15945000

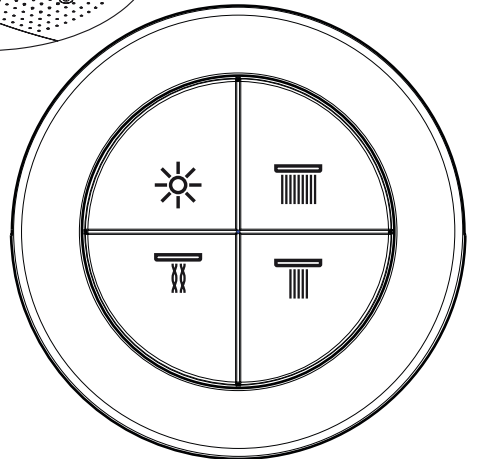
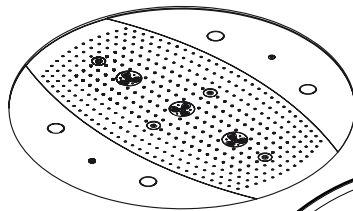

Viskas išjungta



Rain



Whirl



Rainflow



Šviesa



Rain AIR XXL



Rain AIR

Dušas ir šviesa: įjungimas ir išjungimas:

(Standartinė funkcija su šviesa)

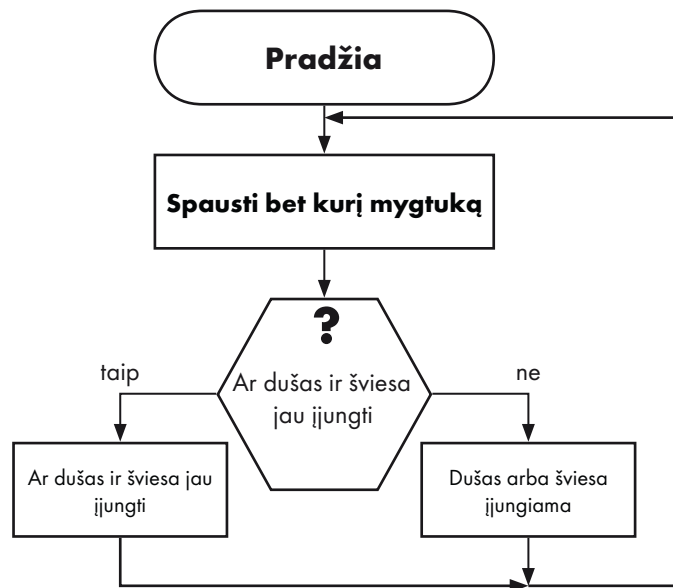

Dušas: įjungimas ir išjungimas::

(Standartinė funkcija be šviesos)

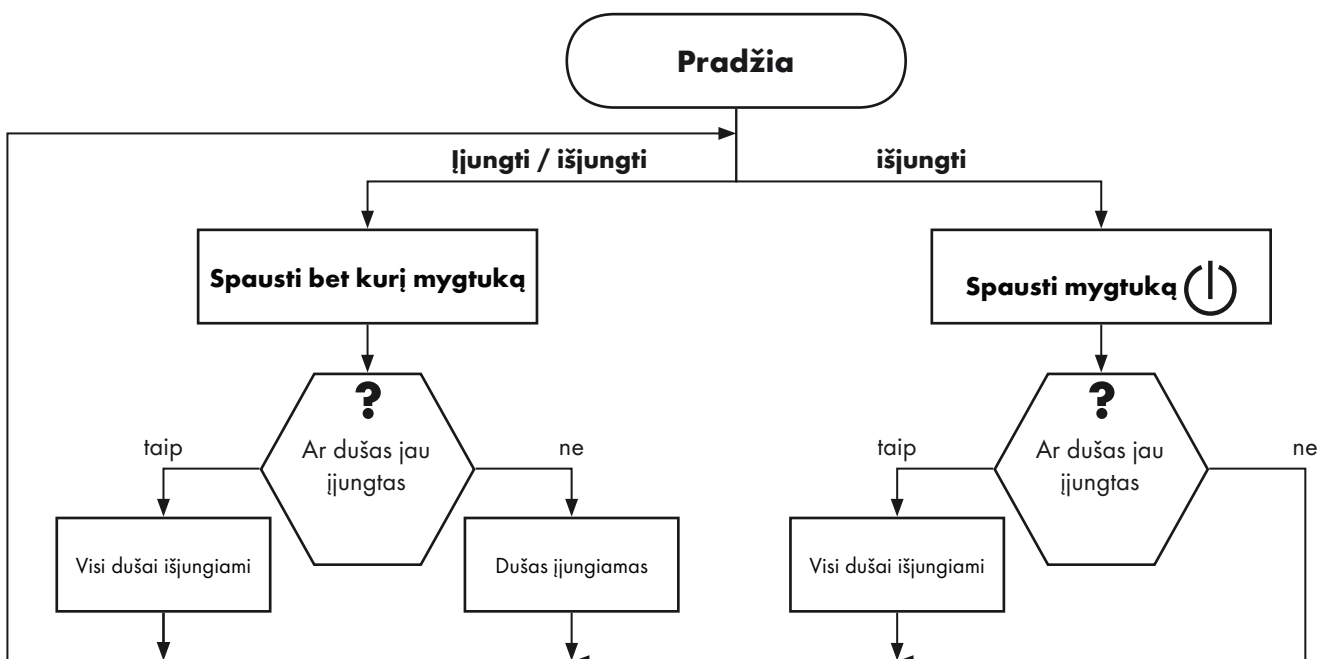

Lietuviškai Vartotojo lygmuo

Raindance Rainfall
28411000

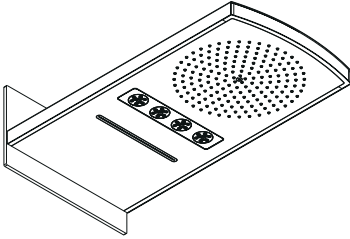

Darbinis režimas

Nuoroda:
Visi dušai turi būti išjungti



Priežiūros mas

Nuoroda:
Šviesos kištukas ir tinkantis tik į tam tikrą lizdą kištukas blykčioja 4 x

Nuoroda:
Šviesos kištukas ir tinkantis tik į tam tikrą lizdą kištukas blykčioja 2 x

Nuoroda:
Šviesos kištukas ir kištukas, tinkantis tik į tam tikrą lizdą, užgesa

< 15 s.

> 15 s.

Du kartus paspausti mygtuką (power icon) arba (sun icon)

Du kartus paspausti mygtuką (showerhead icon)

Maksimali režimo trukmė

Nuoroda:
Šviesos kištukas ir tinkantis tik į tam tikrą lizdą kištukas blykčioja kas s.

Dušo režimas

Nuoroda:
Šviesos kištukas ir tinkantis tik į tam tikrą lizdą kištukas blykčioja 2 s.

< 15 s.

> 15 s.

< 15 s.

> 15 s.

Paspausti mygtuką (power icon) arba (sun icon)

Spausti mygtuką (showerhead icon)

Spausti mygtuką (showerhead icon)

Spausti mygtuką (showerhead icon)

Paspausti mygtuką (power icon) arba (sun icon)

Spausti mygtuką (showerhead icon)

Trukmė
Dušas: 30 s
Šviesa: 30 min

Standartas:
Trukmė
Dušas: 60 s
Šviesa: 30 min

Trukmė:
Dušas: 180 s
Šviesa: 30 min

Trukmė
Dušas + šviesa neribotai

Standartas
Galima įjungti daugiausiai 2 dušus



Komfortas 1:
Vienu metu galima įjungti visus dušus

Lietuviškai Vartotojo lygmuo

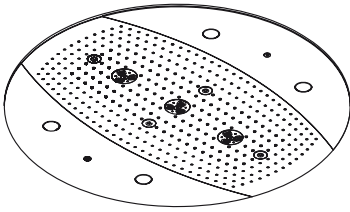

Raindance Rainmaker
28403000 / 28404000





Darbinis režimas



Nuoroda: 
Visi dušai turi būti išjungti 



Nuoroda: 
Šviesos kištukas ir kištukas, tinkantis tik į tam tikrą lizdą, užgęsta 



Priežiūrosmas

Nuoroda: 
Šviesos kištukas ir tinkantis tik į tam tikrą lizdą kištukas blykčioja 4 x 

Nuoroda: 
Šviesos kištukas ir tinkantis tik į tam tikrą lizdą kištukas blykčioja 2 x 



< 15 s.

> 15 s.



Du kartus paspausti mygtuką  arba 

Du kartus paspausti mygtuką 

Maksimali režimo trukmė

Nuoroda: 
Šviesos kištukas ir tinkantis tik į tam tikrą lizdą kištukas blykčioja kas s. 

Dušo režimas





Nuoroda: 
Šviesos kištukas ir tinkantis tik į tam tikrą lizdą kištukas blykčioja 2 s. 

< 15 s.





> 15 s.

< 15 s.

> 15 s.

Paspausti mygtuką  arba 	Spausti mygtuką 	Spausti mygtuką 	Spausti mygtuką 
--	---	---	---

Trukmė Dušas: 30 s Šviesa: 30 min	Standartas: Trukmė Dušas: 60 s Šviesa: 30 min	Trukmė: Dušas: 180 s Šviesa: 30 min	Trukmė Dušas + šviesa neribotai
--	--	--	---

Paspausti mygtuką  arba 	Spausti mygtuką 	Spausti mygtuką 
--	---	---

Standartas Galima įjungti daugiausiai 2 dušus	Komfortas 1: Vienu metu galima įjungti visus dušus	Komfortas 2: Didesni vandens kiekiai, reikalingi tik „lietaus“ funkcijai
---	--	--

Lietuviškai Eksperto lygmuo

Raindance Rainfall
28411000

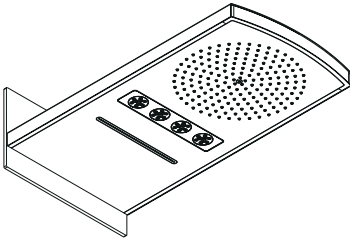

Darbinis režimas

Nuoroda:
Visi dušai turi būti išjungti



Priežiūros mas
Nuoroda:
Šviesos kištukas ir tinkantis tik į tam tikrą lizdą kištukas blykčioja 4 x

Nuoroda:
Šviesos kištukas ir tinkantis tik į tam tikrą lizdą kištukas blykčioja 2 x

Nuoroda:
Šviesos kištukas ir kištukas, tinkantis tik į tam tikrą lizdą, užgesa

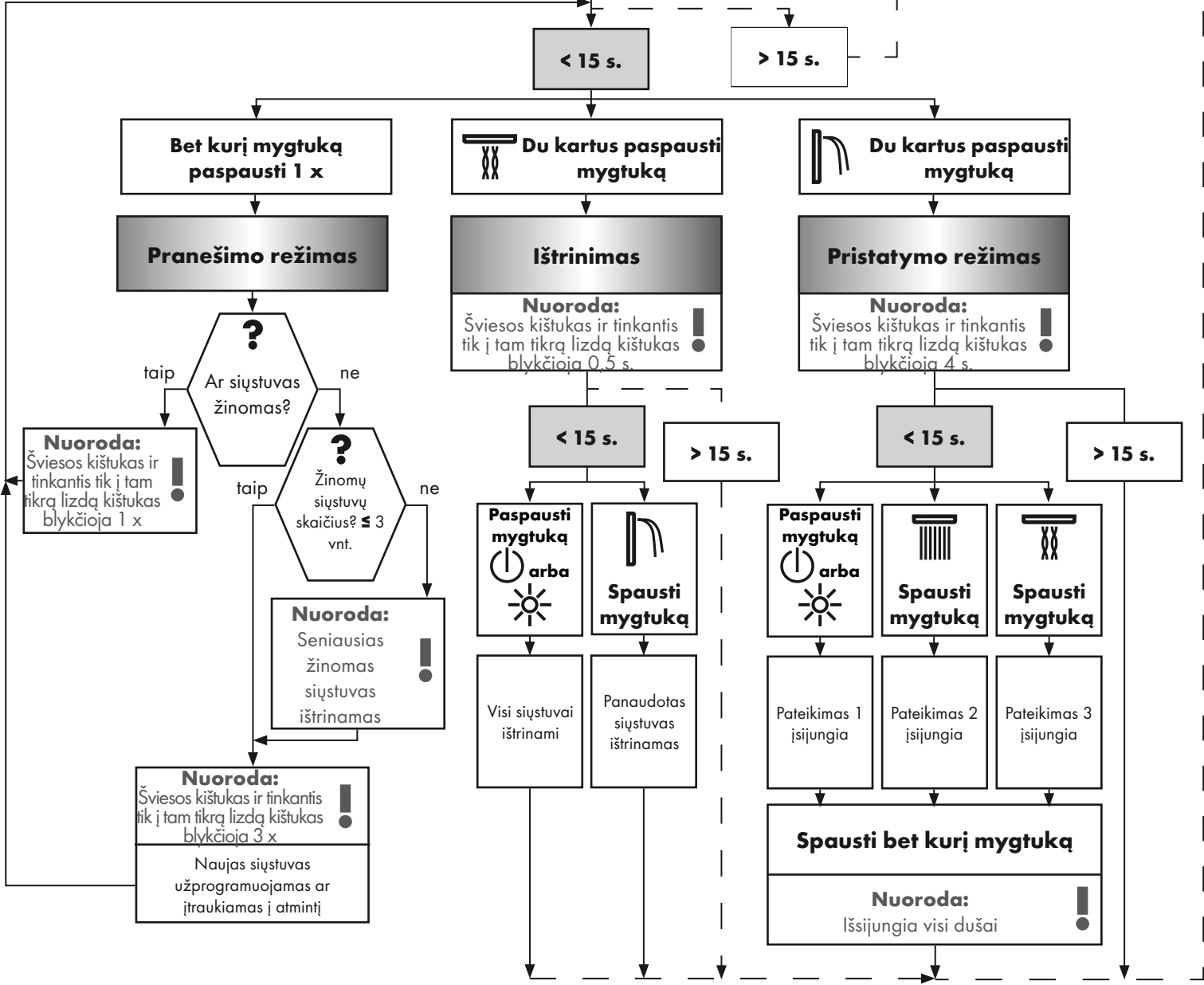

Lietuviškai Eksperto lygmuo

Raindance Rainmaker
28403000 / 28404000

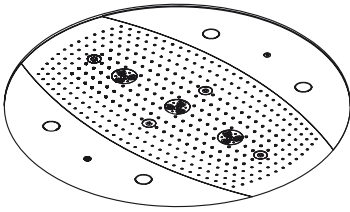

Darbinis režimas

Nuoroda:
Visi dušai turi būti išjungti



Priežiūrosmas
Nuoroda:
Šviesos kištukas ir tinkantis tik į tam tikrą lizdą kištukas blykčioja 4 x

Nuoroda:
Šviesos kištukas ir tinkantis tik į tam tikrą lizdą kištukas blykčioja 2 x

Nuoroda:
Šviesos kištukas ir kištukas, tinkantis tik į tam tikrą lizdą, užgesa

< 15 s.

> 15 s.

Bet kurį mygtuką paspausti 1 x

Pranešimo režimas

Ar siųstuvai žinomas?

taip

ne

Nuoroda:
Šviesos kištukas ir tinkantis tik į tam tikrą lizdą kištukas blykčioja 1 x

Žinomų siųstuvų skaičius? ≤ 3 vnt.

taip

ne

Nuoroda:
Seniausias žinomas siųstuvai ištrinamas

Nuoroda:
Šviesos kištukas ir tinkantis tik į tam tikrą lizdą kištukas blykčioja 3 x
Naujas siųstuvai užprogramuojamas ar įtraukiamas į atmintį

Du kartus paspausti mygtuką

Ištrinimas
Nuoroda:
Šviesos kištukas ir tinkantis tik į tam tikrą lizdą kištukas blykčioja 0,5 s.

< 15 s.

> 15 s.

Paspausti mygtuką
arba

Spausti mygtuką

Visi siųstuvai ištrinami

Panaudotas siųstuvai ištrinamas

Du kartus paspausti mygtuką

Pristatymo režimas
Nuoroda:
Šviesos kištukas ir tinkantis tik į tam tikrą lizdą kištukas blykčioja 4 s.

< 15 s.

> 15 s.

Paspausti mygtuką
arba

Spausti mygtuką

Spausti mygtuką

Pateikimas 1 įsijungia

Pateikimas 2 įsijungia

Pateikimas 3 įsijungia

Spausti bet kurį mygtuką
Nuoroda:
Išsijungia visi dušai

Norme i direktive:

Primjenu proizvoda jamče sljedeće direktive:

- EN 15200
- EN 60335-2-105



Sigurnosne upute:

- Proizvod se smije primjenjivati samo za kupanje, tuširanje i osobnu higijenu.
- Djeca ne smiju koristiti sustav tuša bez nadzora.
- Djeca, kao i tjelesno, mentalno i/ili senzorno hendikepirane odrasle osobe ne smiju se koristiti sustavom tuša bez nadzora. Osobe koje su pod utjecajem alkohola ili droga ne smiju se koristiti sustavom tuša.
- Mora se izbjegavati kontakt mlaza iz tuša s osjetljivim dijelovima tijela (npr. očima). Tijelo korisnika mora biti dovoljno udaljeno od tuša.
- Velika razlika u pritisku između vruće i hladne vode mora biti izbalansirana.



Električni priključak:

- Električne instalacijske i ispitne radove smiju obavljati samo certificirani električari uz uvažavanje odredaba VDE 0100 dio 701 i IEC 60364-7-701.
- Za priključivanje u struju potrebna je samo jedna utičnica. Napajanje strujom se provodi preko vanjskog transformatora.
- U neposrednoj se blizini ne smiju nalaziti lako zapaljivi materijali.
- Okolna temperatura ne smije prekoračiti 50 °C.
- Cjelokupno napajanje strujom provodi se preko 230V/N/PE/50Hz priključka izmjenične struje.
- Vod se mora osigurati nadstrujnom zaštitnom sklopkom (RCD/FI) s nazivnom diferencijalnom strujom ≤ 30 mA.
- Ako je potrebno izjednačenje potencijala, mora ga osigurati klijent.
- Prilikom provedbe električnih instalacijskih radova treba se pridržavati odgovarajućih, trenutno važećih propisa strukovne udruge elektrotehničara (u Njemačkoj: VDE), državnih propisa te propisa lokalnog poduzeća za distribuciju električne energije.
- Mora se omogućiti odvajanje proizvoda sa strujne mreže. To se može postići ili lako dostupnim utikačem ili višepolnom sklopkom sukladno EN 60335-1 st. 24.3.



Sastavljanje: (pogledaj stranicu 303)

- Pažnja! Cijevi moraju biti postavljene, isprane i testirane prema važećim normama. (Instalacija prema standardu EN 1717)
Vidi upute za montažu:
Raindance Rainfall 28411000
Raindance Rainmaker 28403000 / 28404000 / 28417000 / 28418000
- Radovi bilo koje vrste smiju se obavljati samo u beznaponskom stanju.
- Moguća je samo okomita ugradnja tijela 15941180!
Montaža s prstenom za namještanje (A) moguća je samo u prednjem i središnjem području!
- Sve komponente moraju biti lako dostupne.

Tehnički podaci:

Najveći dopušteni tlak:	tlak 1 MPa
Preporučeni tlak:	0,1 - 0,5 MPa
Probni tlak:	1,6 MPa
(1 MPa = 10 bar = 147 PSI)	
Temperatura vruće vode:	tlak 80 ° C
Preporučena temperatura vruće vode:	65 ° C
Razmak od sredine:	G 3/4
Spojevi ulaz:	Miješana voda
Slobodan protok na 0,3 MPa:	
1 Trošilo:	35 l/min
2 Trošilo:	45 l/min



Pribor: (pogledaj stranicu 174)



Mjere: (pogledaj stranicu 292)



Primjeri instalacija Raindance Rainfall: (pogledaj stranicu 295)



Primjeri instalacija Raindance Rainmaker: (pogledaj stranicu 299)



Upotreba: (pogledaj stranicu 176)

- Tuš se ne može koristiti ako dođe do ispada 230 V mrežnog napona.
- Proizvod nije predviđen za primjenu u parnim kupaonicama!





























Čišćenje Rešetkasti filter: (pogledaj stranicu 309)

Rezervni dijelovi (pogledaj stranicu 311)

Hrvatski Tehničke informacije

Greška	Uzrok	Otklanjanje
Bez ikakvih funkcija	<ul style="list-style-type: none"> - Nema opskrbe napona - Transformator osnovne garnitura je u kvaru - Prijemnik nepovoljno pozicioniran / u kvaru - Predajnik nije prilagođen ili je u kvaru 	<ul style="list-style-type: none"> - Osigurajte opskrbu napona - Zamijenite transformator - Premjestite prijemnik ili ga zamijenite - Prilagodite ili zamijenite predajnik
Radni se modus se ne može konfigurirati	<ul style="list-style-type: none"> - Reed kontakt nije na odgovarajućem položaju iza rozete - Reed kontakt neispravan 	<ul style="list-style-type: none"> - Postavite Reed kontakt na rozetu - Zamijenite priključni vod magnetskog ventila
Nema funkcije svjetla	<ul style="list-style-type: none"> - Transformator Rainmaker nije priključen ili je neispravan - Dovodi optičkog releja neispravni / u kvaru 	<ul style="list-style-type: none"> - Osigurajte opskrbu napona transformatora / zamijenite transformator - Provjerite / zamijenite spojeve i optičke releje
Trošila se samostalno isključuju	<ul style="list-style-type: none"> - Vrijeme protoka pohranjeno u programskom modusu 	<ul style="list-style-type: none"> - Produžite / isključite zaustavno vrijeme u servisnom modusu
Armatura ne brtvi	<ul style="list-style-type: none"> - Magnetski ventil je prljav / neispravan 	<ul style="list-style-type: none"> - Očistite / zamijenite membranu magnetskog ventila
Protok je premali	<ul style="list-style-type: none"> - Filtar za skupljanje nečistoće na ulaznoj strani je zaprljan 	<ul style="list-style-type: none"> - Očistite/zamijenite filtara za skupljanje nečistoće

Simbolima

	priključak na dovod vode DN 20 topla voda		transformator		Izjednačenje potencijala
	priključak na dovod vode DN 20 hladna voda		Prijemnik		sve isključeno
	Otvorite dotok vode		kodni utikač		svjetlo
	Zatvorite vodu		230V		Rain
	Zajamčena funkcija od • naviše		12V		Whirl
	Protok vode mora biti veći od 50 l/min.		Prazna cijev		Rainflow
	Odvod		Kontroler osvjetljenja 27189000 (Nije sadržano u isporuci!)		Rain AIR XXL
	Sredina tuš-kada		Svjetlosni relej Rainmaker		Rain AIR
			transformator Rainmaker		Silikon (ne sadrži kiseline)
			Postojeći priključak od 12 V za svjetlo (maks. 80 W)		

Sastavljanje pogledaj stranicu 303

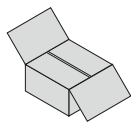

Hrvatski Pribor

Transformator:

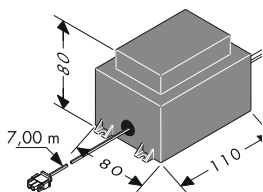

Snaga vanjskog transformatora iznosi 50 VA. Transformator se mora instalirati u suhoj zoni (zaštitna zona 3). Transformator se zajedno s prijemnikom može ugraditi u plastično kućište, pri čemu se mora uvažiti odredba EN/IEC 60335-1.. (dimenzija ca. 250 x 160 x 92 mm, nije sadržana u isporuci.) Isporučeni kabel omogućava instalaciju transformatora na udaljenosti do 7,00 m od prijemnika. U tu se svrhu mora predvidjeti jedna prazna cijev EN35 (nije sadržana u isporuci). Prazna cijev se mora fiksirati na rastojanjima ne većim od 500 mm, a polumjer savijanja mora biti veći od 100 mm.

Sekundarni vod transformatora dugačak oko 7,00 m se ne smije kratiti. Nepotrebna dužina se

treba ostaviti u blizini sigurnosnog transformatora. Oštećeni priključni vod se ne smije zamjenjivati. U tom se slučaju transformator ne smije više uključivati.

Oštećeni priključni vod se ne smije zamjenjivati. Ako je priključni vod za napajanje neispravan, kvalificirani električar mora zamijeniti cjelokupni vod zajedno s transformatorom.

Svjetlosni relej:

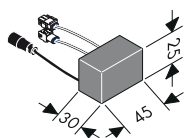

(samo kod varijanti s ugrađenim svjetlom)

Opterećenje releja smije iznositi maksimalno 12 V AC / 80 W.

Nije dozvoljeno priključenje na mrežni napon od 230 V.

Kontroler osvjetljenja: 27189000

(Nije sadržano u isporuci!)

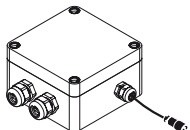

(iControl mobile 15944000)

Kontroler osvjetljenja se mora priključiti kod varijanti s vanjskim izvorom svjetla.

Kontroler osvjetljenja mora u svako doba biti dostupan.

Kodni utikač:

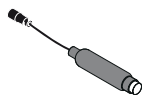

(Raindance Rainfall 28411000 / Raindance Rainmaker 28403000)

Kod varijanti bez svjetla mora se priključiti kodni utikač.

Ako je kod varijanti bez svjetla aktivan servisni modus, LED indikator na kodnom utikaču svijetli.

Kodni utikač mora u svako doba biti dostupan.

Priključni vod blok magnetskih ventila / Priključni vod svjetlo:



Vod bloka magnetskih ventila dugačak 7,50 m, te svjetlosni vod dužine 10,00 m, se ne smiju kratiti. Nepotrebna dužina se treba ostaviti u blizini prijemnika.

Vod bloka magnetskog ventila i svjetlosni vod se smiju položiti samo u isporučenoj praznoj cijevi (EN 20).

Prazna cijev se mora fiksirati na rastojanjima ne većim od 500 mm, a polumjer savijanja mora biti veći od 100 mm.

Pažnja: U praznoj cijevi za vod bloka magnetskih ventila i svjetlosni vod se ne smiju polagati električni vodovi napona većeg od 12 V.

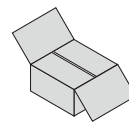

Prijemnik:

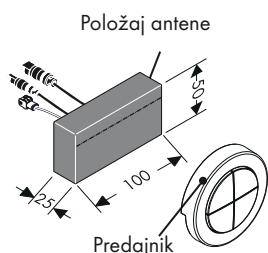

Prijemnik je poželjno montirati u istoj prostoriji u kojoj se nalazi i dio za tuširanje.

Ako to nije moguće, prijemnik se može montirati i u susjednoj prostoriji.

Prijemnik se ne smije ugrađivati u metalno kućište, jer bi ono onemogućilo radiosignal predajnika. Također, mora se obratiti pozornost da se što manje metalnih dijelova, koji ometaju prijem signala, nalazi u blizini mjesta ugradnje prijemnika.

Radi optimalnog prijema radiosignala, antena prijemnika treba biti okrenuta prema predajniku.

Predajnik:



Prijemnik je prigodom isporuke već podešen na prijem signala s odgovarajućeg predajnika. Također, predajnik i prijemnik su, radi lakšeg prepoznavanja, označeni istim serijskim brojem. Ako se želi prijem signala s dodatnih, odnosno naknadno kupljenih predajnika, prijemnik se mora posebno podesiti. Maksimalno je moguće podešavanje prijema, odnosno pamćenje, četiri predajnika. (pogledaj stranicu 180/181 Modus za prijavljivanje).

Predajna frekvencija iznosi 868,3 MHz.

Uputa: Domet predajnika i prijemnika iznosi ca. 10,00 m. Točna vrijednost ovisi o prigušenju signala između predajnika i prijemnika.

Uputa: Iz sigurnosnih razloga predajnik koristite samo u vidnom polju sustava tuša. U suprotnom bi se voda mogla nehotice pustiti.

Uputa: Pravilan postupak pri zamjeni neispravnog predajnika novim:

1. Izbrisati sve predajnike. (Modus za prijavljivanje ⇒ Modus za brisanje).
2. Provesti prepoznavanje svih predajnika, sem neispravnog. (Modus za servisni ⇒ Modus za prijavljivanje).

materijal	prigušenje
drvo, gips, staklo (neobložen, bez metala)	0 - 10 %
opeka, pločasti drveni materijali	5 - 35 %
beton sa željeznom armaturom	10 - 90 %
metal, izolacijska aluminijska folija	90 - 100 %

Magnet:



Za aktivaciju servisnog modusa magnet mora aktivirati REED kontakt (iza rozete). (pogledaj stranicu 178/179 Modus za servisni).

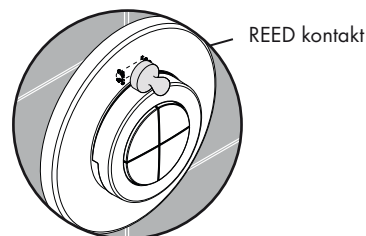

Raindance Rainfall

28411000

iControl mobile

15940180 / 15942000

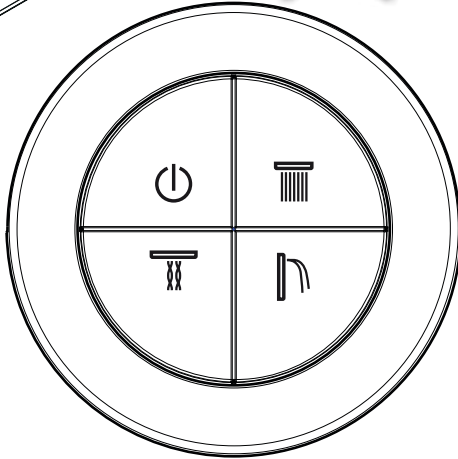
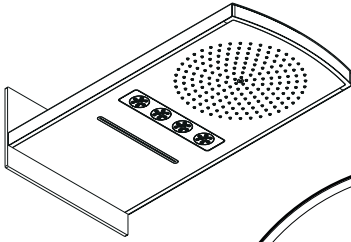

Raindance Rainfall

28411000

iControl mobile

15941180 / 15944000

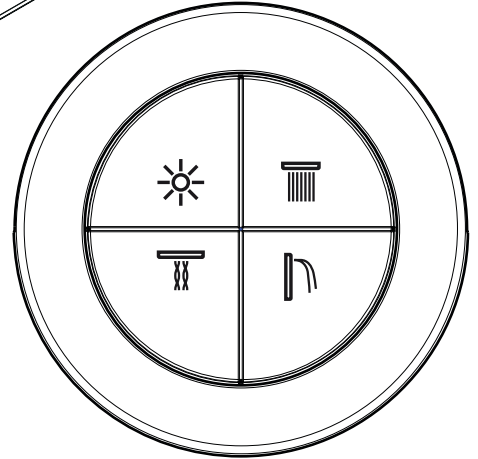
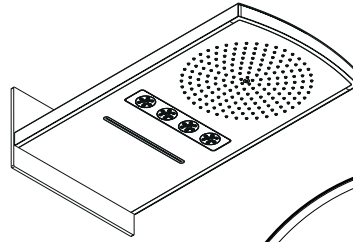

Raindance Rainmaker

28403000

iControl mobile

15940180 / 15943000

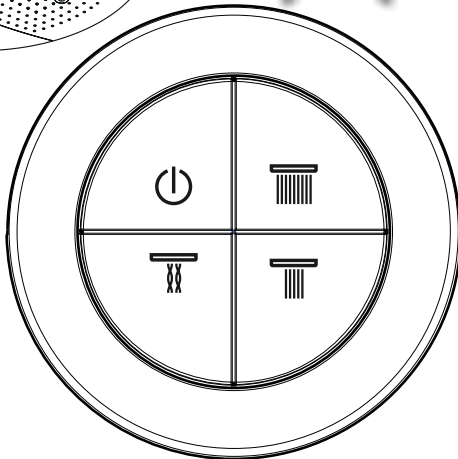
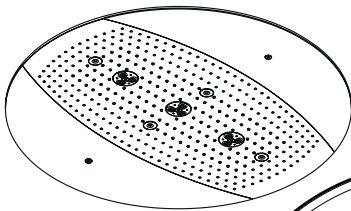

Raindance Rainmaker

28404000

iControl mobile

15941180 / 15945000

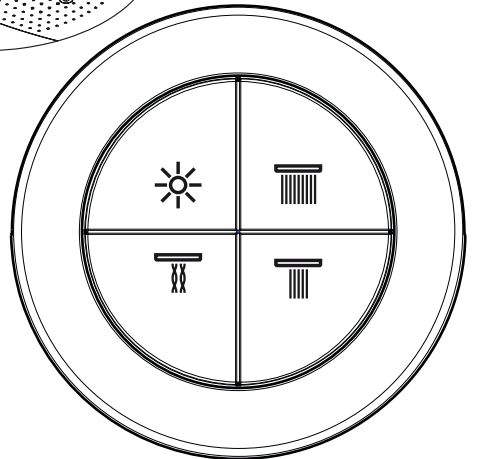
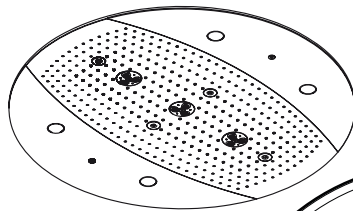

sve isključeno



Rain



Whirl



Rainflow



svjetlo



Rain AIR XXL



Rain AIR

Sastavljanje pogledaj stranicu 303

Uključite i isključite tuševe i svjetlo:

(Standardna funkcija sa svjetlom)

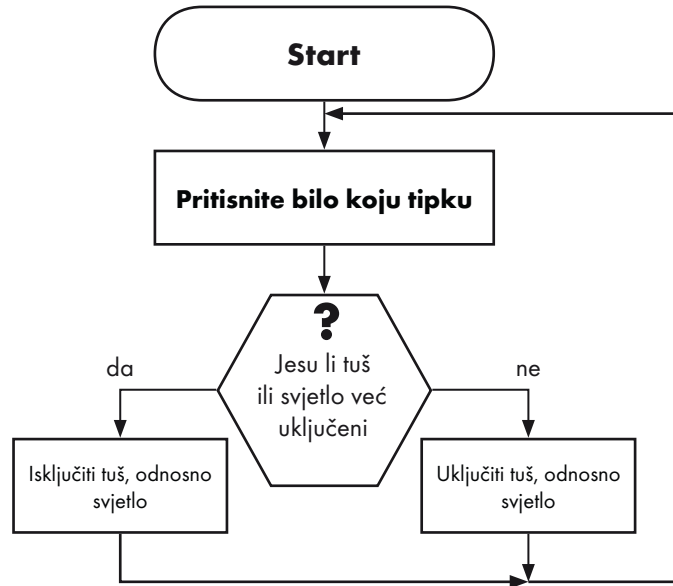

Uključivanje i isključivanje tuševa:

(Standardna funkcija bez svjetla)

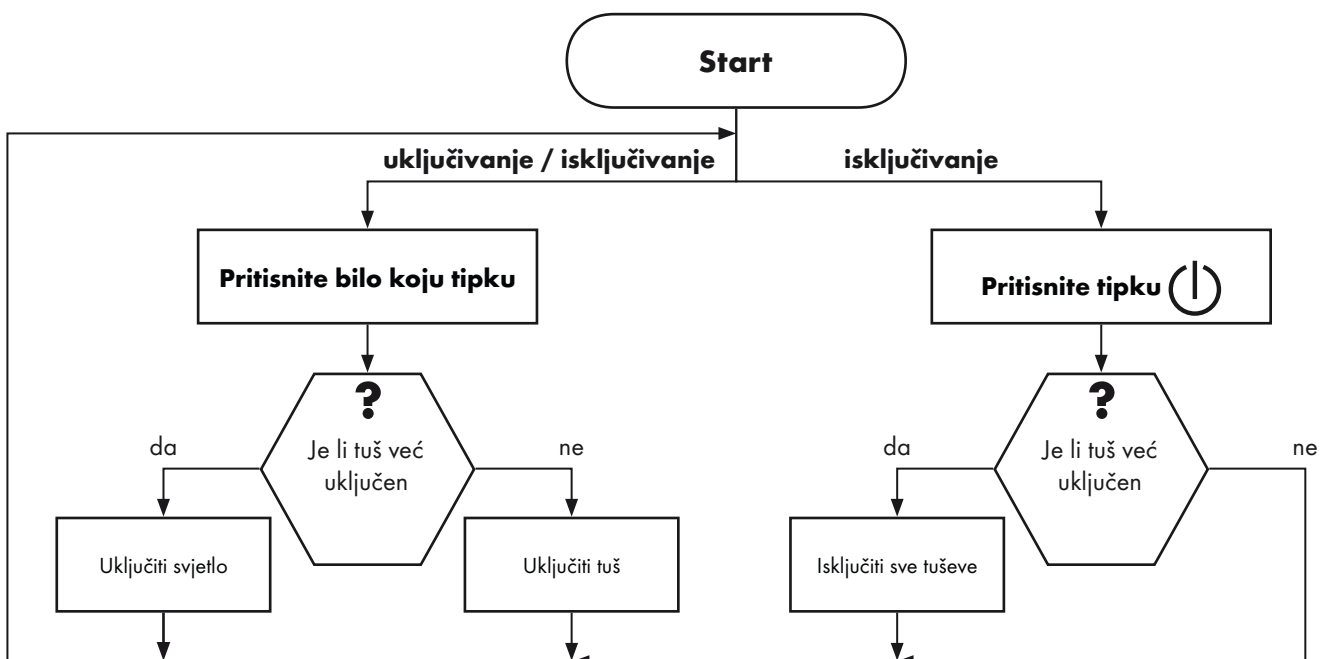

Hrvatski Razina za korisnike

Raindance Rainfall
28411000

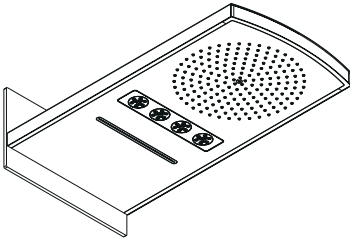

Radni modus

Uputa:
Svi tuševi moraju biti
isključeni



Modus za servisni

Uputa:
svjetlo / kodni utikač
žmiga 4 x

Uputa:
svjetlo / kodni utikač se
gasi

Uputa:
svjetlo / kodni utikač
žmiga 2 x

< 15 s

> 15 s

duplo pritisnite tipku
🔌 ili ☀️

**duplo pritisnite
tipku**

**Modus s maksimalnim
vremenom protoka**

Uputa:
svjetlo / kodni utikač
žmiga 1 put u sekundi

Modus za tuširanje

Uputa:
svjetlo / kodni utikač
žmiga 2 put u sekundi

< 15 s

> 15 s

< 15 s

> 15 s

**pritisnite
tipku**
🔌 ili ☀️

**Pritisnite
tipku**

**Pritisnite
tipku**

**Pritisnite
tipku**

**pritisnite
tipku**
🔌 ili ☀️

**Pritisnite
tipku**

**Vremena
protoka:**
tuševi: 30 s
svjetlo: 30 min

standard:
**Vremena
protoka:**
tuševi: 60 s
svjetlo: 30 min

**Vremena
protoka:**
tuševi: 180 s
svjetlo: 30 min

**Vremena
protoka:**
tuševi + svjetla:
beskonačno

standard

komfor 1:
svi tuševi se
mogu istodobno
uključiti

Hrvatski Razina za korisnike

Raindance Rainmaker
28403000 / 28404000

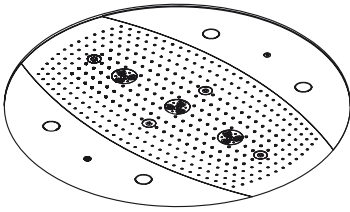

Radni modus

Uputa:
Svi tuševi moraju biti
isključeni



Modus za servisni

Uputa:
svjetlo / kodni utikač
žmiga 4 x

Uputa:
svjetlo / kodni utikač se
gasi

Uputa:
svjetlo / kodni utikač
žmiga 2 x

< 15 s

> 15 s

duplo pritisnite tipku
🔌 ili ☀️

duplo pritisnite tipku
🚿

**Modus s maksimalnim
vremenom protoka**

Uputa:
svjetlo / kodni utikač
žmiga 1 put u sekundi

Modus za tuširanje

Uputa:
svjetlo / kodni utikač
žmiga 2 put u sekundi

< 15 s

> 15 s

< 15 s

> 15 s

pritisnite tipku
🔌 ili ☀️

Pritisnite tipku
🚿

Pritisnite tipku
🚿

Pritisnite tipku
🚿

pritisnite tipku
🔌 ili ☀️

Pritisnite tipku
🚿

Pritisnite tipku
🚿

Vremena protoka:
tuševi: 30 s
svjetlo: 30 min

standard:
Vremena protoka:
tuševi: 60 s
svjetlo: 30 min

Vremena protoka:
tuševi: 180 s
svjetlo: 30 min

Vremena protoka:
tuševi + svjetla:
beskonačno

standard
mogu se uključiti
najviše dva tuša

komfor 1:
svi tuševi se
mogu istodobno
uključiti

komfor 2:
veća količina
vode, potrebna
samo za
rainmaker

Hrvatski Razina za stručnjake

Raindance Rainfall
28411000

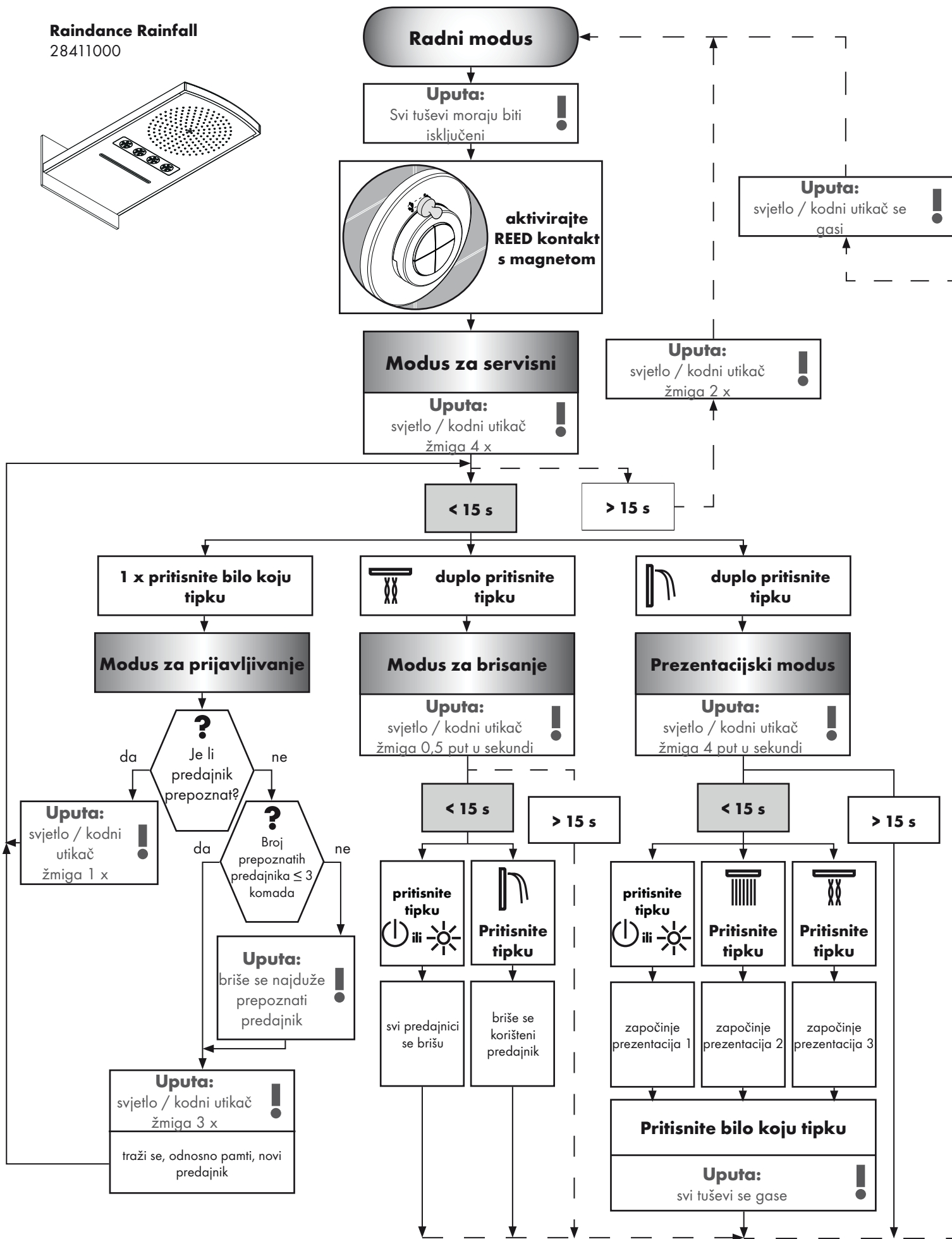
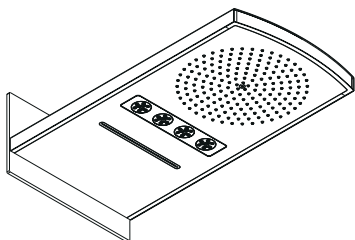

Hrvatski Razina za stručnjake

Raindance Rainmaker
28403000 / 28404000

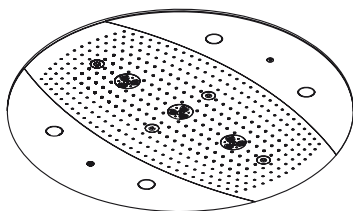

Radni modus

Uputa:
Svi tuševi moraju biti isključeni

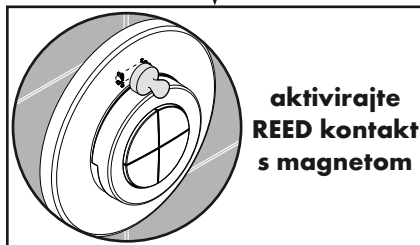

Modus za servisni
Uputa:
svjetlo / kodni utikač žmiga 4 x

Uputa:
svjetlo / kodni utikač žmiga 2 x

Uputa:
svjetlo / kodni utikač se gasi

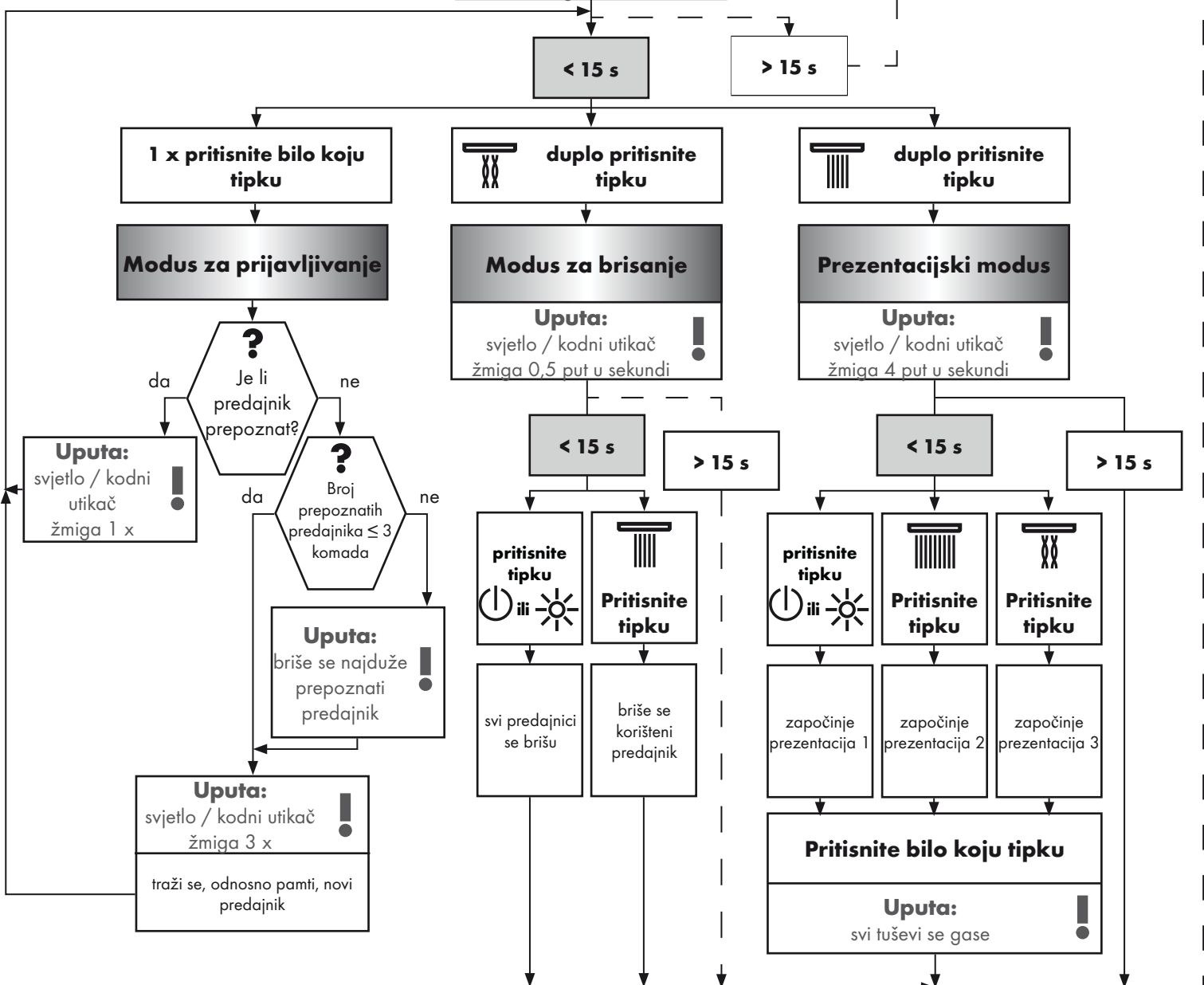

Normlar ve yönergeler:

Ürünün kullanımı aşağıdaki yönergelerle garanti edilmiştir:

- EN 15200
- EN 60335-2-105



Güvenlik uyarıları:

- Duş sistemi yalnızca banyo, hijyen ve beden temizliği amaçları doğrultusunda kullanılabilir.
- Çocukların gözetimsiz olarak duş sistemini kullanmaları yasaktır.
- Bedensel, ruhsal ve/veya sensörük engelli çocuk ve yetişkinler gözetimsiz olarak duş sistemini kullanmamalıdır. Alkol veya uyuşturucu etkisinde olanlar duş sistemini kullanmamalıdır.
- Püskürtme başlıklarının hassas organlara teması (örn. gözler) önlenmelidir. Püskürtücü ile beden arasında yeterli mesafe bırakılmalıdır.
- Sıcak ve soğuk su bağlantıları arasında büyük basınç farklılıkları varsa, bu basınç farklılıklarının dengelenmesi gerekir.



Elektrik bağlantısı:

- Kurulum ve kontrol çalışmaları, VDE 0100 Bölüm 701 ve IEC 60364-7-701'i dikkate almak suretiyle, elektronik konusunda uzman yetkili bir kişi tarafından gerçekleştirilmelidir.
- Elektrik bağlantısı için sadece bir prize ihtiyaç vardır. Güç kaynağı bir harici trafo üzerinden gerçekleştirilmelidir.
- Yakında kolay alev alabilen malzemeler bulunmamalıdır.
- Çevre sıcaklığı 50 °C'nin üzerinde olmamalıdır.
- Tüm güç beslemesi bir 230V/N/PE/50Hz alternatif akım bağlantısı üzerinden gerçekleştirilir.
- Emniyete alma, ≤ 30 mA ölçüm farkı akımı olan bir hatalı akım koruma tertibatı (RCD/FI) üzerinden gerçekleştirilmelidir.
- Bir potansiyel dengelemesi gerekiyorsa, yapı tarafında oluşturulmalıdır.
- Elektrik montajı sırasında güncel sürümdeki ilgili VDE, ülke ve EVU talimatlarına uyulmalıdır.
- Ürünün elektrik şebekesinden ayrılabilmesi garantiye alınmalıdır. Ya rahat erişilebilen bir priz ya da EN 60335-1 Paragraf 24.3 uyarınca tüm kutuplu bir şalter üzerinden.



Montajı: (Bakınız sayfa 303)

- Önemli! Batarya monte edilmeli, geçerli normlardan sonra akis testi yapılmalıdır. (DIN 1717'ye göre montaj) Montaj talimatına bakın: Raindance Rainfall 28411000 Raindance Rainmaker 28403000 / 28404000 / 28417000 / 28418000
- Tüm çalışmalar sadece gerilimsiz durumda yapılmalıdır.
- Taban elemanı 15941180, sadece dikey takılabilir! Ayar halkası (A) ile montaj yalnızca ön ve orta alanda yapılabilir!
- Tüm bileşenler kolay ulaşılabilir durumda kalmalıdır.

Teknik bilgiler:

İşletme basıncı:	azami 1 MPa
Tavsiye edilen işletme basıncı:	0,1 - 0,5 MPa
Kontrol basıncı:	1,6 MPa
(1 MPa = 10 bar = 147 PSI)	
Sıcak su sıcaklığı:	azami 80 ° C
Tavsiye edilen su ısıtı:	65 ° C
Bağlantı ölçüleri:	G 3/4
Bağlantılar Giriş:	Karıştırma suyu
0,3 MPa serbest akış:	
1 Tüketici:	35 l/dak
2 Tüketici:	45 l/dak



Aksesuar: (Bakınız sayfa 184)



Ölçüleri: (Bakınız sayfa 292)



Montaj Örneği Raindance Rainfall: (Bakınız sayfa 295)



Montaj Örneği Raindance Rainmaker: (Bakınız sayfa 299)



Kullanımı: (Bakınız sayfa 186)

- 230 V şebeke geriliminin kesilmesi durumunda duş tertibatı işleme alınmaz.
- Ürün bir buhar banyosu ile bağlantılı olarak kullanım için önerilmemiştir!





























Temizleme Filtre: (Bakınız sayfa 309)

Yedek parçalar (Bakınız sayfa 311)

Türkçe Teknik bilgiler

Arıza	Sebebe	Yardıma
Hiçbir fonksiyon yok	- Gerilim beslemesi yok - Temel setin trafosu arızalı - Alıcı hatalı konumlandırılmış / arızalı - Verici tanıtılmamış / arızalı	- Gerilim beslemesini emniyete alın - Trafosu değiştirin - Alıcının konumunu değiştirin ya da alıcıyı değiştirin - Vericiyi tanıttın / değiştirin
İşletim modu yapılandırılmıyor	- Reed Kontakt rozet arkasındaki uygun konumunda değil - Reed Kontakt hatalı	- Reed Kontakt'ı rozet üzerine konumlandırın - Manyetik valf bağlantı hattını değiştirin
Işık fonksiyonu yok	- Rainmaker trafosu takılı değil / hatalı - Işık rölesi girişleri hatalı / arızalı	- Trafonun gerilim beslemesini emniyete alın / trafosu değiştirin - Bağlantıları ve ışık rölesini kontrol edin / değiştirin
Tüketiciler kendiliğinden kapanıyor	- Çalışma süresi program modunda belirtilmiş	- Servis modunda ilave çalışma süresini uzatın / kapatın
Armatür sızdırıyor	- Manyetik valf kirli / arızalı	- Manyetik valf membranlarını temizleyin / değiştirin
Akış çok az	- Giriş tarafındaki kir toplama eleği kirli	- Filtreyi temizleyin / değiştirin

Semboller

	Su bağlantısı DN 20 Sıcak su		Trafo		Potansiyel dengelemesi
	Su bağlantısı DN 20 Soğuk su		Alıcı		her şey kapalı
	Suyu açın		Kodlama soketi		Aydınlatma
	Suyu kesin		230V		Rain
	•'den itibaren fonksiyon garanti edilmiştir.		12V		Whirl
	Akış kapasitesi 50 l/dak üzerinde olmalıdır. > 50 l/min		Boş boru		Rainflow
	Akış Raindrain		Işık kumandası 27189000 (Teslimat kapsamına dahil değildir!)		Rain AIR XXL
	Duş küvetinin ortası		Aydınlatma röleleri Rainmaker		Rain AIR
			Trafo Rainmaker		Silikon (asetik asit içermeyen)
			Firmada ışık için (maks. 80 W) ön montajı yapılmış 12 V bağlantı		

Montajı Bakınız sayfa 303

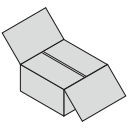

Türkçe Aksesuar

Trafo:

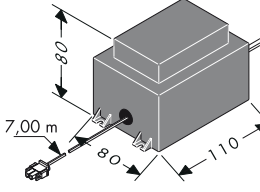

Harici trafonun performansı 50 VA'dır. Trafo kuru bir bölgeye (koruma bölgesi 3) monte edilmelidir. Trafo alıcı ile birlikte EN/IEC 60335-1'i dikkate almak suretiyle bir plastik muhafaza içerisinde takılabilir. (ölçüler yakl. 250 x 160 x 92 mm, teslimat kapsamına dahil değildir.) Birlikte teslim edilen kablo, trafonun alıcıdan 7,00 m uzağa kadar kurulumunu mümkün kılar. Bunun için önceden bir EN35 boş boru (teslimat kapsamına dahil değildir) ayarlanmalıdır. Boş boru en az her 500 mm'de bir sabitlenmeli ve bükme yarı çapı 100 mm'den daha yüksek olmalıdır.

Trafonun yaklaşık 7,00 m uzunluğundaki tali hattı kısaltılmamalıdır. İhtiyaç duyulmayan hat uzunluğu, sigorta transformatörünün yakınına konul-

malıdır. Hasar görmüş bir bağlantı hattı yenisi ile değiştirilmemelidir. Trafo hasarının ardından çalıştırılmamalıdır.

Hasar görmüş bir bağlantı hattı yenisi ile değiştirilmemelidir. Arızalı bir şebeke bağlantısı hattında hat, trafo dahil olmak üzere bir elektrik uzmanı tarafından değiştirilmelidir.

Aydınlatma röleleri:

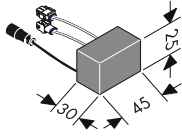

(yalnızca entegre ışıklı seçeneklerde)

Aydınlatma rölesi azami 12 V AC / 8 W ile yüklenmelidir.

230 V ağı üzerindeki bir çalışmaya izin verilmemektedir.

Işık kumandası:

27189000

(Teslimat kapsamına dahil değildir)

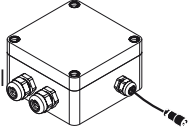

(iControl mobile 15944000)

Işık kumandası harici ışık kaynaklı seçeneklerde bağlanmalıdır. Işık kumandası daima erişilebilir olmalıdır.

Kodlama soketi:

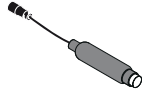

(Raindance Rainfall 28411000 / Raindance Rainmaker 28403000)

Kodlama soketi, aydınlatmasız seçeneklerde bağlanmalıdır.

Aydınlatmasız seçeneklerde servis modu aktif haldeyse, kodlama soketinin aydınlatma diyodu optik geri bildirimleri gösterir.

Kodlama soketi daima erişilebilir olmalıdır.

Bağlantı hattı Manyetik valf bloğu / Bağlantı hattı Aydınlatma:



7,50 m uzunluğundaki manyetik valf bloğu hattı ve 10,00 m uzunluğundaki aydınlatma hattı kısaltılmamalıdır. İhtiyaç duyulmayan hat uzunluğu alıcının yakınına konulmalıdır.

Manyetik valf bloğu hattı ve aydınlatma hattı sadece birlikte teslim edilen boş boru (EN 20) içerisine yerleştirilmelidir.

Boş boru en az her 500 mm'de bir sabitlenmeli ve bükme yarı çapı 100 mm'den daha yüksek olmalıdır.

Önemli: Manyetik valf bloğu hattı ve aydınlatma hattı boş borularına 12 V'tan büyük gerilime sahip elektrikli kablolar konmamalıdır.

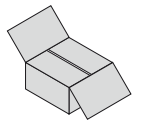

Alıcı:

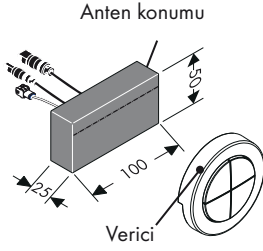

Alıcı, özellikle duş tertibatı ile aynı mekana takılı olmalıdır.

Bu söz konusu değilse, alıcı, duş tertibatına yakın bir mekana da takılabilir.

Alıcının telsiz sinyalleri parazitleneceğinden, alıcının metal muhafaza içerisine takılmaması gerekir. Ayrıca alıcı montaj yerinin yakınında mümkün olduğunca az parazite neden olabilecek metal parçaların bulunmasına dikkat edilmelidir.

Telsiz sinyallerinin mükemmel bir şekilde algılanabilmesi için, alıcı antenin mümkün olduğunca vericiye dönük olması gerekir.

Verici:



Verici teslim anında alıcıya önceden adapte edilmiş haldedir. Verici tamamen aynı seri numaraları sayesinde alıcıya düzenlenebilmektedir.

İlave veya sonradan satın alınmış vericiler adapte edilmelidir. Azami dört alıcı adapte edilebilir veya hafızaya alınabilir. (Bakınız sayfa 190/191 Kayıt olma modu).

Vericinin telsiz frekansı 868,3 MHz'dir.

Bilgi: Alıcı ve verici yakl. 10,00 m'lik kapsama alanına sahiptir. Kapsama alanı alıcı ve verici arasındaki telsiz sinyallerinin ne kadar kısılmış olduklarına bağlıdır.

Bilgi: Güvenlik sebepleriyle vericiyi yalnızca duş sisteminin görünen bölgesinde kullanın. Aksi takdirde yanlışlıkla su açılabilir.

Bilgi: Arızalı bir vericinin yeni bir verici ile değiştirilmesi durumunda yapılması gerekenler:

1. Tüm vericileri silin. (Kayıt olma modu ⇒ Silme modu).
2. Arızalı verici dışındaki tüm vericiler adapte edilmelidir. (Servis modu ⇒ Kayıt olma modu).

Malzeme	Kısılma
Ahşap, alçı, cam (tabakasız, metalsiz)	0 - 10 %
Tuğla, preslenmiş plakalar	5 - 35 %
Betonarme demir	10 - 90 %
Metal, alüminyum kapatma	90 - 100 %

Mıknatıs:



Servis modunu etkinleştirmek için mıknatıs REED kontağına (rozetin arkasında) dokunmalıdır. (Bakınız sayfa 188/189, Servis modu).

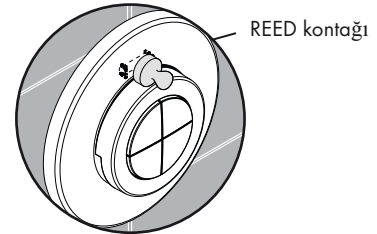

Türkçe Kullanımı

Raindance Rainfall

28411000

iControl mobile

15940180 / 15942000

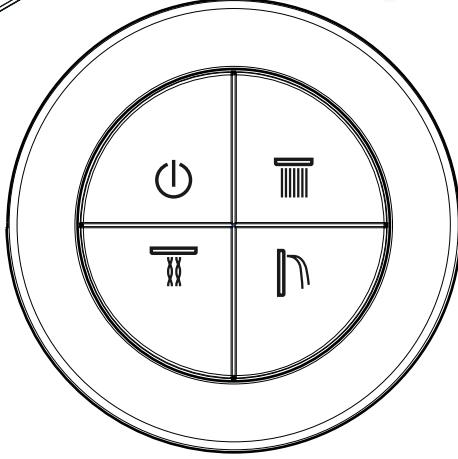
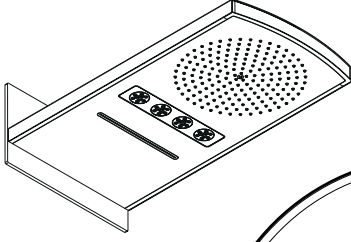

Raindance Rainfall

28411000

iControl mobile

15941180 / 15944000

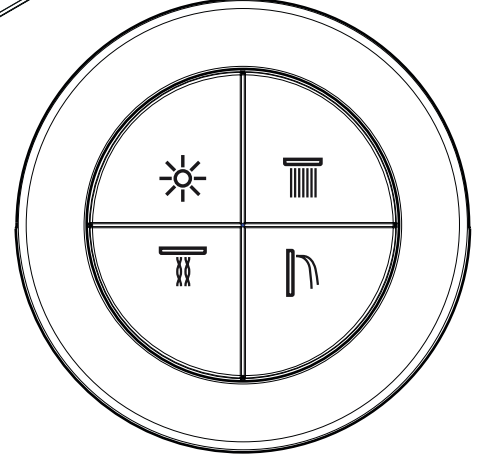
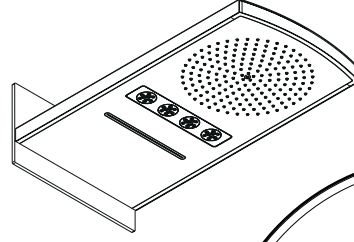

Raindance Rainmaker

28403000

iControl mobile

15940180 / 15943000

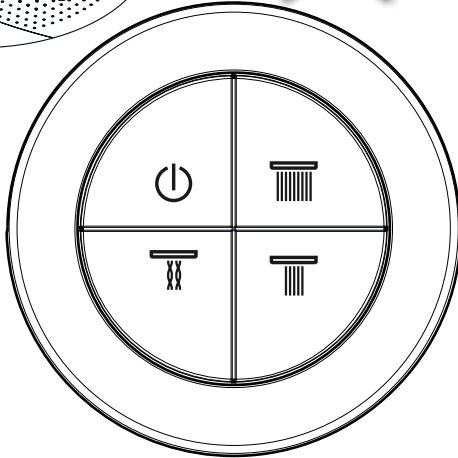
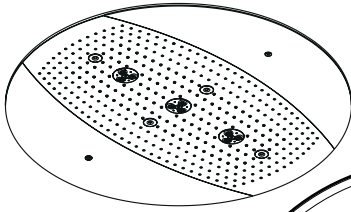

Raindance Rainmaker

28404000

iControl mobile

15941180 / 15945000

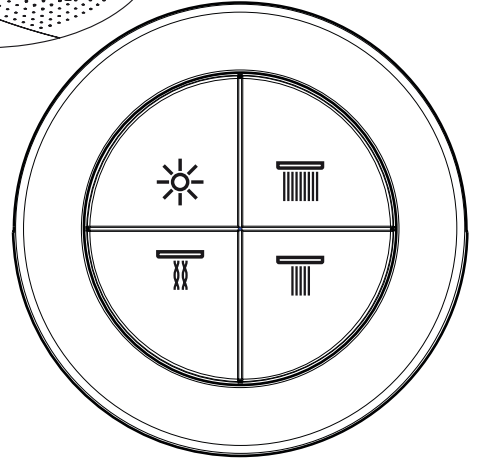
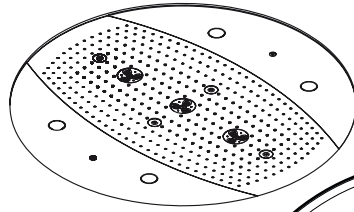

her şey kapalı



Rain



Whirl



Rainflow



Aydınlatma



Rain AIR XXL



Rain AIR

Montajı Bakınız sayfa 303

Köpürme ve aydınlatmayı açma / kapama:
(Standardfunktion mit Licht)

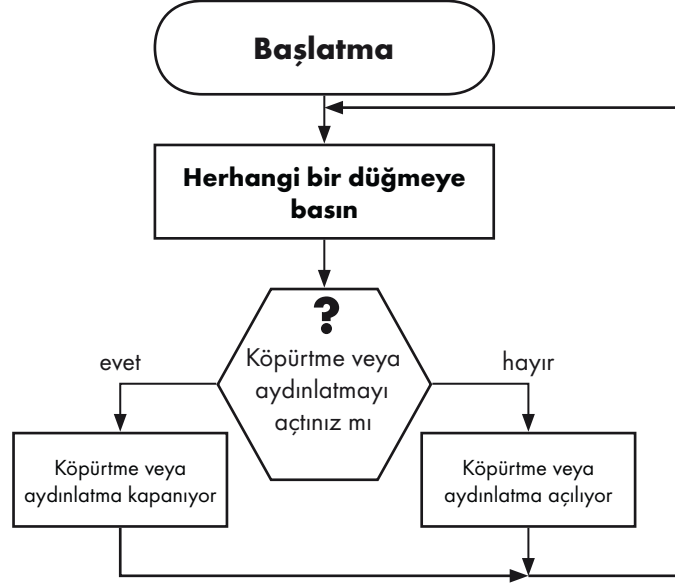

Köpürmeyi açma ve kapama:
(Aydınlatmasız standart fonksiyon)

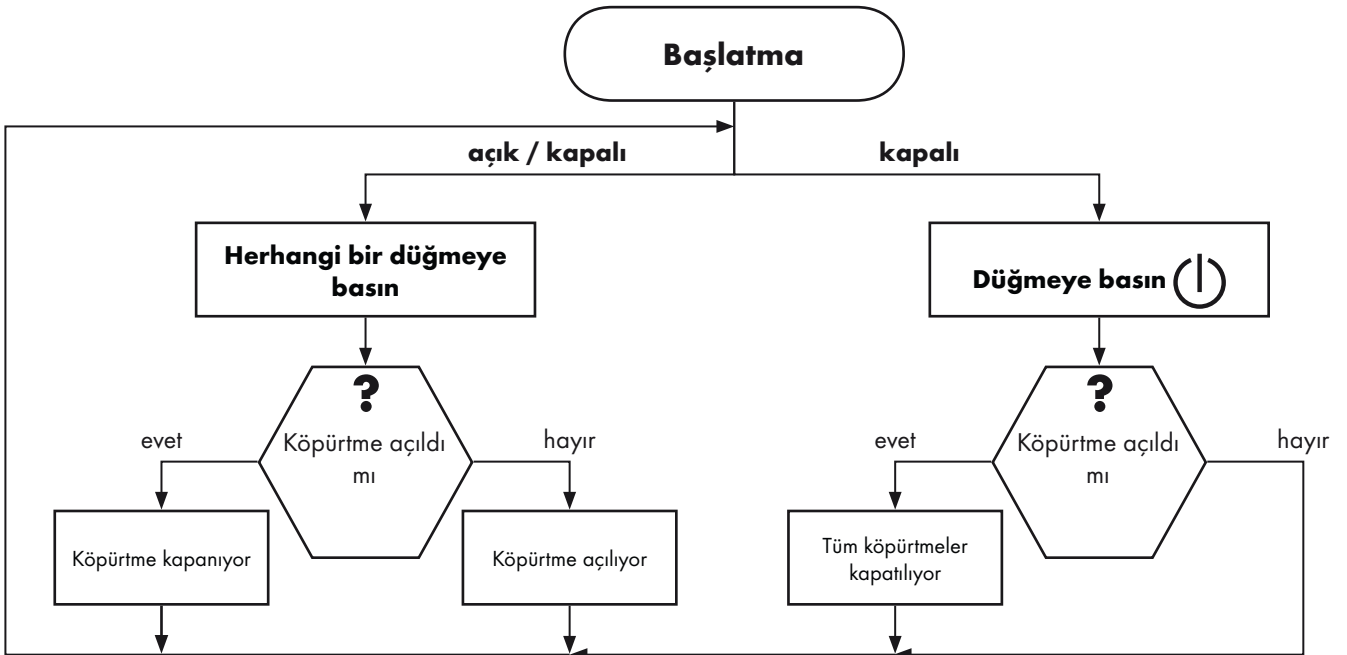

Türkçe Kullanıcı düzeyi

Raindance Rainfall
28411000

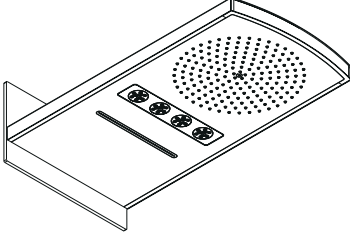

Çalıştırma modu

Bilgi:

Tüm köpürtmeler kapatılmalı

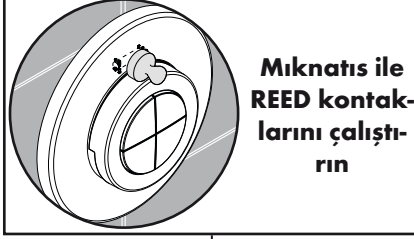

Mıknatıs ile
REED kontak-
larını çalıştı-
rın

Servis modu

Bilgi:

Aydınlatma / kodlama
soketi
4 kez yanıp sönüyor

Bilgi:

Aydınlatma / kodlama
soketi sönüyor

Bilgi:

Aydınlatma / kodlama
soketi 2 kez yanıp sönüyor

< 15 saniye

> 15 saniye

veya
düğmesine iki kez basın

düğmesine iki kez
basın

Azami çalışma süresi modu

Bilgi:

Aydınlatma / kodlama soketi
1 saniye ara ile yanar

Köpürme modu

Bilgi:

Aydınlatma / kodlama soketi
2 saniye ara ile yanar

< 15 saniye

> 15 saniye

< 15 saniye

> 15 saniye



Çalışma süreleri: Köpürme: 30 s Aydınlatma: 30 min	Standart: Çalışma süreleri: Köpürme: 60 s Aydınlatma: 30 min	Çalışma süreleri: Köpürme: 180 s Aydınlatma: 30 min	Çalışma süreleri: Köpürme + Aydınlatma: daimi
--	--	---	---

Standart Azami 2 köpür- me çalıştırılabilir	Konfor 1: Tüm köpürmeler aynı anda çalıştırılabilir
--	---

Türkçe Kullanıcı düzeyi

Raindance Rainmaker
28403000 / 28404000

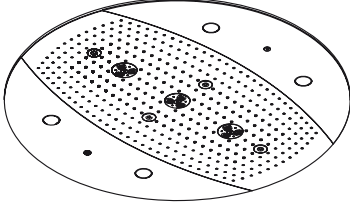

Çalıştırma modu

Bilgi:

Tüm köpürtmeler kapatılmalı

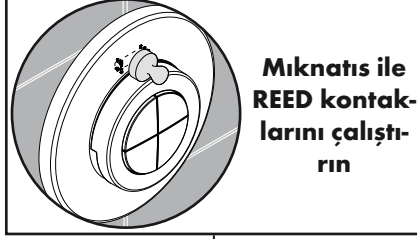

Mıknatıs ile
REED kontak-
larını çalıştı-
rın

Servis modu

Bilgi:

Aydınlatma / kodlama
soketi
4 kez yanıp sönüyor

Bilgi:

Aydınlatma / kodlama
soketi sönüyor

Bilgi:

Aydınlatma / kodlama
soketi 2 kez yanıp sönüyor

< 15 saniye

> 15 saniye

veya
düğmesine iki kez basın

düğmesine iki kez
basın

Azami çalışma süresi modu

Bilgi:

Aydınlatma / kodlama soketi
1 saniye ara ile yanar

Köpürme modu

Bilgi:

Aydınlatma / kodlama soketi
2 saniye ara ile yanar

< 15 saniye

> 15 saniye

< 15 saniye

> 15 saniye



Çalışma süreleri: Köpürme: 30 s Aydınlatma: 30 min	Standart: Çalışma süreleri: Köpürme: 60 s Aydınlatma: 30 min	Çalışma süreleri: Köpürme: 180 s Aydınlatma: 30 min	Çalışma süreleri: Köpürme + Aydınlatma: daimi
--	--	---	---

Standart Azami 2 köpür- me çalıştırılabilir	Konfor 1: Tüm köpürmeler aynı anda çalıştırılabilir	Konfor 2: Büyük çaptaki su miktarı sadece Rainmaker'da gereklidir
--	---	--

Türkçe Gelişmiş düzey

Raindance Rainfall
28411000

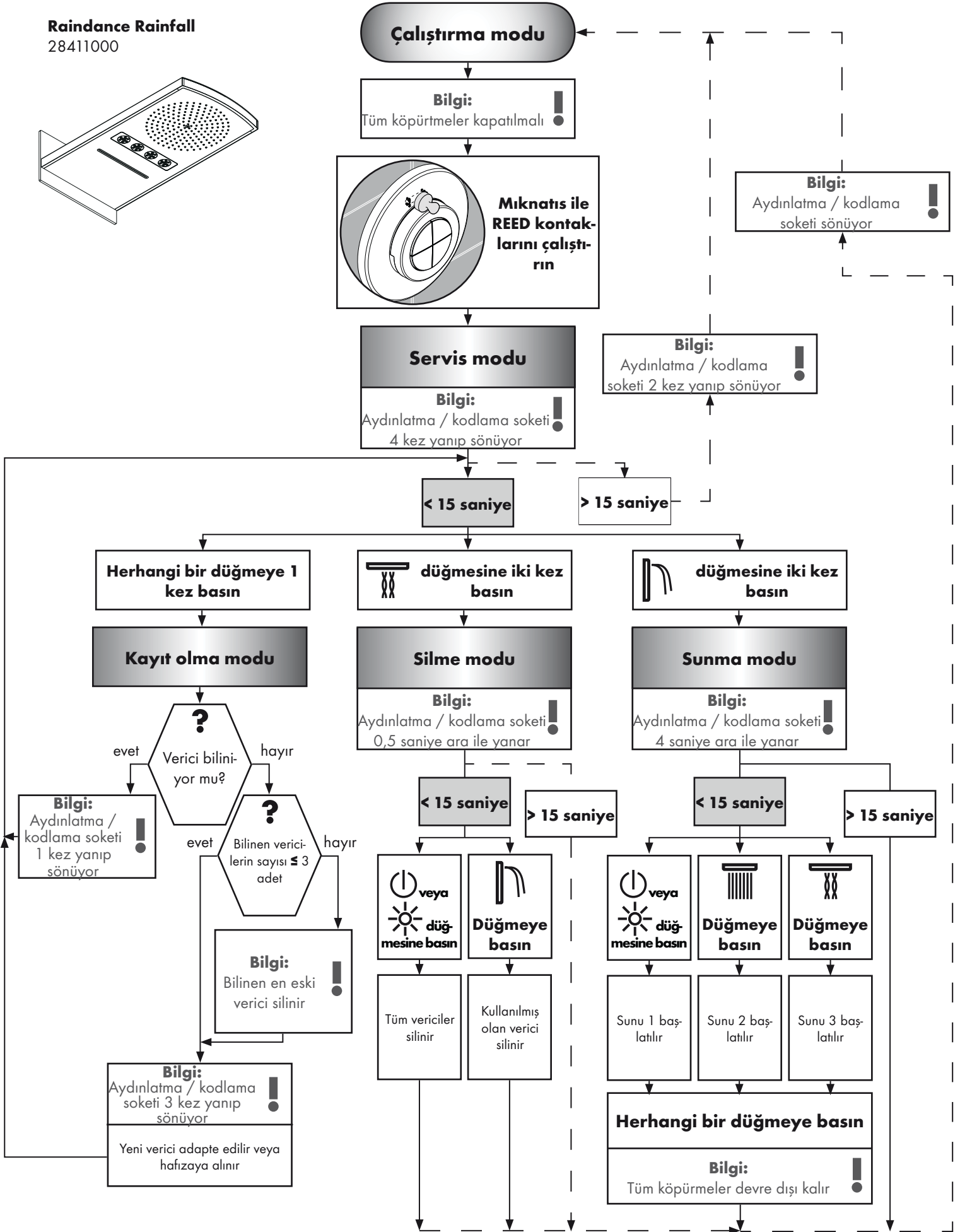
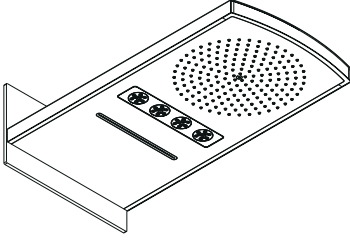

Türkçe Gelişmiş düzey

Raindance Rainmaker
28403000 / 28404000

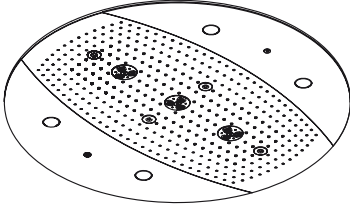

Çalıştırma modu

Bilgi:
Tüm köpürtmeler kapatılmalı

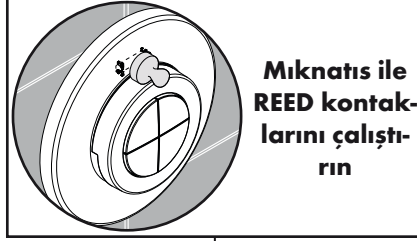

Mıknatıs ile REED kontaklarını çalıştırın

Servis modu

Bilgi:
Aydınlatma / kodlama soketi 4 kez yanıp sönüyor

Bilgi:
Aydınlatma / kodlama soketi 2 kez yanıp sönüyor

Bilgi:
Aydınlatma / kodlama soketi sönüyor

< 15 saniye

> 15 saniye

Herhangi bir düğmeye 1 kez basın

Kayıt olma modu

Verici biliniyor mu?

evet

hayır

Bilgi:
Aydınlatma / kodlama soketi 1 kez yanıp sönüyor

Bilinen vericilerin sayısı ≤ 3 adet

evet

hayır

Bilgi:
Bilinen en eski verici silinir

Bilgi:
Aydınlatma / kodlama soketi 3 kez yanıp sönüyor

Yeni verici adapte edilir veya hafızaya alınır

Silme modu

Bilgi:
Aydınlatma / kodlama soketi 0,5 saniye ara ile yanar

< 15 saniye

> 15 saniye



Tüm vericiler silinir



Kullanılmış olan verici silinir

düğmesine iki kez basın

Sunma modu

Bilgi:
Aydınlatma / kodlama soketi 4 saniye ara ile yanar

< 15 saniye

> 15 saniye



Sunu 1 başlatılır



Sunu 2 başlatılır



Sunu 3 başlatılır

Herhangi bir düğmeye basın

Bilgi:
Tüm köpürtmeler devre dışı kalır

Norme și directive:

Utilizarea produsului este garantată de următoarele directive:

- EN 15200
- EN 60335-2-105



Instrucțiuni de siguranță:

- Sistemul de duș poate fi utilizat doar pentru spălarea, menținerea igienei și curățarea corpului.
- Nu lăsați copii să folosească sistemul de duș nesupravegheați.
- Copiii și adulții cu dizabilități corporale, mintale și senzoriale nu pot utiliza sistemul de duș nesupravegheați. De asemenea este interzisă utilizarea sistemului de duș de către persoane, care se află sub influența alcoolului sau a drogurilor.
- Evitați contactul jetului de apă cu părțile de corp sensibile (de ex. ochii). Țineți dușul la o distanță corespunzătoare de corp.
- Diferențele de presiune mari între alimentarea cu apă rece și apă caldă trebuie echilibrate.



Conexiune electrică:

- Lucrările de instalare și de verificare trebuie efectuate de către electricieni specializați, ținând cont de VDE 0100 Partea 701 și IEC 60364-7-701.
- Pentru conectarea electrică se necesită un singur conector. Alimentarea cu curent electric se realizează printr-un transformator extern.
- În imediata apropiere nu trebuie să se găsească niciun fel de materiale ușor inflamabile.
- Temperatura mediului înconjurător nu trebuie să depășească 50 °C.
- Alimentarea completă cu curent electric se realizează printr-un bransament de curent alternativ de 230V/N/PE/50Hz.
- Instalația trebuie asigurată printr-un dispozitiv de protecție împotriva curentului rezidual (RCD/ FI)
- pentru curent rezidual măsurat de ≤ 30 mA.
- Dacă este nevoie de un stabilizator de tensiune, acesta trebuie asigurat de către client.
- La montarea instalației electrice trebuie respectate prescripțiile VDE (Verband Deutscher Elektrotechniker = Asociația Electro-tehnicienilor din Germania), prescripțiile din țara respectivă și prescripțiile EVU (Elektrizitäts-Versorgungs-Unternehmen = Într
- Trebuie asigurată posibilitatea deconectării produsului de la rețea. Ori printr-un ștecăr ușor accesibil ori printr-un întrerupător capabil să deconecteze toți polii conform EN 60335-1 par. 24.3.



Montare: (vezi pag. 303)

- Atenție! Bateria trebuie montată, clătită și verificată conform normelor în vigoare. (Instalare conform EN 1717)
Vezi instrucțiunile de montare:
Raindance Rainfall 28411000
Raindance Rainmaker 28403000 / 28404000 / 28417000 / 28418000
- Toate lucrările trebuie efectuate doar când sistemul este scos de sub tensiune.
- Corpul de bază 15941180 poate fi instalat doar în poziție orizontală! Montarea cu inelul de reglare (A) este posibilă doar în domeniul din față și din mijloc!
- Toate piesele trebuie să rămână accesibile.

Date tehnice:

Presiune de funcționare::	max. 1 MPa
Presiune de funcționare recomandată:	0,1 - 0,5 MPa
Presiune de verificare::	1,6 MPa
(1 MPa = 10 bar = 147 PSI)	
Temperatura apei calde::	max. 80 °C
Temperatura recomandată a apei calde:	65 °C
Interax racorduri:	G 3/4
Racorduri Alimentare:	Apă amestecată
Debit cu curgere liberă la 0,3 MPa:	
1 Consumator:	35 l/min
2 Consumator:	45 l/min



Accesorii: (vezi pag. 194)



Dimensiuni: (vezi pag. 292)



Exemple de montare Raindance Rainfall: (vezi pag. 295)



Exemple de montare Raindance Rainmaker: (vezi pag. 299)



Utilizare: (vezi pag. 196)

- În cazul întreruperii tensiunii de rețea de 230 V instalația de duș nu poate fi pusă în funcțiune.
- Produsul nu este prevăzut pentru a fi folosit în combinație cu o baie de aburi!



Curățare Sită de impurități: (vezi pag. 309)



























Piese de schimb (vezi pag. 311)

Montare vezi pag. 303

Română Informații tehnice

Deranjament	Cauza	Măsuri de remediere
Fără funcție	<ul style="list-style-type: none"> - Nu există tensiune de alimentare - Transformatorul setului de bază este defect - Receptorul este așezat incorect / defect - Emițătorul nu este setat / defect 	<ul style="list-style-type: none"> - Asigurați alimentarea cu tensiune - Schimbați transformatorul - Schimbați poziția receptorului, respectiv receptorul - Setați / schimbați emițătorul
Modul de operare nu poate fi configurat	<ul style="list-style-type: none"> - Senzorul Reed nu se află într-o poziție corectă în spatele rozetei - Senzorul Reed este defect 	<ul style="list-style-type: none"> - Plasați senzorul Reed la rozetă - Schimbați cablul de conexiune al ventilului magnetic
Fără funcție de lumină	<ul style="list-style-type: none"> - Transformatorul Rainmaker nu este conectat / defect - Conductele releului de lumină stricate / defecte 	<ul style="list-style-type: none"> - Asigurați alimentarea cu tensiune a transformatorului / schimbați transformatorul - Verificați / schimbați conexiunile și releul de lumină
Consumatorii se opresc automat	<ul style="list-style-type: none"> - Timp de funcționare salvat în modul de program 	<ul style="list-style-type: none"> - Prolungați / ștergeți decalajul de timp în modul service
Armătură neetanșă	<ul style="list-style-type: none"> - Ventilul magnetic este murdar / defect 	<ul style="list-style-type: none"> - Curățați / schimbați membranele ventilului magnetic
Debit prea redus	<ul style="list-style-type: none"> - Sita de captare a murdăriei de la partea de intrare este înfundată 	<ul style="list-style-type: none"> - Curățați / schimbați sita de impurități

Simbol

	Racord de apă DN 20 Apă caldă		Transformator		Egalizare de potențial
	Racord de apă DN 20 Apă rece		Receptor		Toate dispozitivele oprite
	Se introduce apa		Ștecher de codificare		Lumină
	Opriți alimentarea cu apă		230V		Rain
	Începând de la • funcționarea este garantată.		12V		Whirl
	Capacitatea de evacuare trebuie să fie mai mare de 50 l/min.		Tub gol		Rainflow
	Deversor		Comanda luminilor 27189000 (nu sunt incluse în setul livrat!)		Rain AIR XXL
	În mijlocul căzii de duș		Releu de lumină Rainmaker		Rain AIR
			Transformator Rainmaker		Silicon (fără acid acetic!)
			Conexiune de 12 V preinstalată pentru lumină (max. 80 W)		

Montare vezi pag. 303

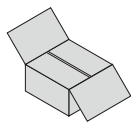

Română Accesorii

Transformator:

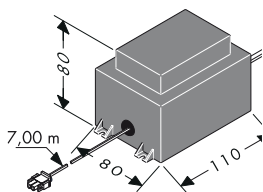

Puterea transformatorului extern trebuie să fie 50 VA. Transformatorul trebuie instalat în mediu uscat (zona de protecție 3). Transformatorul poate fi montat împreună cu receptorul într-o carcasă de plastic, ținând cont de EN/IEC 60335-1. (dimensiuni cca. 250 x 160 x 92 mm, nu este inclus în pachetul de livrare.) Cu ajutorul cablurilor livrate puteți instala transformatorul la o distanță de până la 7,00 m de la receptor. Pentru acesta trebuie prevăzut un tub gol EN35 (nu este inclus în pachetul de livrare). Tubul gol trebuie fixat la cel puțin fiecare 500 m, iar raza de curbură a acestuia trebuie să fie peste 100 mm.

Cablul secundar de o lungime de cca 7,00 m al transformatorului nu trebuie scurtat. Lungimea de

cablu neutilizată trebuie amplasată lângă transformatorul de siguranță. Nu utilizați cabluri de conexiune deteriorate. Transformatorul nu mai poate fi pus în funcțiune.

Nu utilizați cabluri de conexiune deteriorate. În cazul defectării cablului de alimentare, cablul și transformatorul trebuie înlocuite de către un electrician calificat.

Releu de lumină:

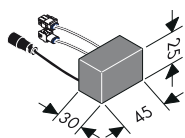

(doar în cazul variantei cu lumină integrată)

Solicitarea maximă a releului de lumină poate fi 12 V AC / 80 W.

Utilizarea acestuia în rețeaua de 230 V nu este permisă.

Comanda luminilor:

27189000

(nu este inclus în setul livrat)

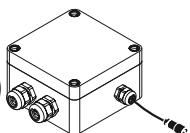

(iControl mobile 15944000)

Comanda luminii trebuie conectată la modelele cu o sursă de lumină exterioară.

Comanda luminii trebuie să fie permanent accesibilă.

Ștecher de codificare:

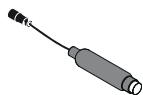

(Raindance Rainfall 28411000 / Raindance Rainmaker 28403000)

Ștecherul de codificare trebuie conectat la modelele fără lumină.

În cazul în care se activează regimul de service la modelele fără lumină, dioda LED de la ștecherul de codificare emite semnalele optice.

Fișa de codare trebuie să rămână accesibilă.

Cablu conectare Blocul de supapă magnetică / Cablu conectare Lumină:



Cablul de la blocul de supapă magnetică de o lungime de 7,50 m, cât și cablul de lumină de o lungime de 10,00 m nu pot fi scurtate. Lungimea de cablu neutilizată trebuie amplasată lângă receptor.

Cablul de la blocul de supapă magnetică și cablul de lumină pot fi amplasate doar în tubul gol livrat (EN 20).

Tubul gol trebuie fixat la cel puțin fiecare 500 m, iar raza de curbură a acestuia trebuie să fie peste 100 mm.

Atenție: În tuburile goale pentru cablul de la blocul de supapă magnetică și cel de lumină nu pot fi amplasate cabluri pentru o tensiune mai mare de 12V.

Montare vezi pag. 303

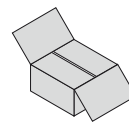

Receptor:

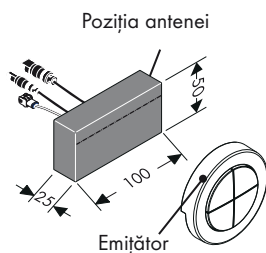

Receptorul trebuie montat de preferință în aceeași încăpere cu instalația de duș.

În cazul în care acest lucru nu este posibil, receptorul poate fi montat într-o altă încăpere din imediata apropiere a instalației de duș.

Receptorul nu poate fi instalat într-o carcasă de metal, deoarece semnalele radio ale emițătorului se vor ecrana de către aceasta. Mai mult, trebuie ținut cont și de faptul, că în apropierea locului de amplasare a receptorului să fie cât mai puține piese

Pentru receptarea optimă a semnalelor radio, antena receptorului trebuie poziționată pe cât posibil în direcția emițătorului.

Emițător:



La livrare emițătorul este deja acordat cu receptorul. Emițătorul poate fi alocat receptorului cu ajutorul numărului de serie identic.

Emițătoarele suplimentare și achiziționate ulterior trebuie de asemenea acordate. Se pot acorda, respectiv salva maxim patru emițătoare. (vezi pag. 200/201 Mod de autentificare).

Frecvența radio a emițătorului este 868,3 MHz.

Observație: Emițătorul și receptorul au o rază de acțiune de cca. 10,00 m. Raza de acțiune depinde și de gradul de atenuare a semnalelor radio dintre emițător și receptor.

Observație: Din motive de securitate utilizați emițătorul doar în aria de acoperire a sistemului de duș. În caz contrar este posibil să porniți din greșeală apa.

Observație: Procedura de operare corectă la înlocuirea unui emițător defect cu unul nou:

1. Ștergeți toate emițătoarele. (Mod de autentificare ⇒ Mod de ștergere).
2. Acordați din nou toate emițătoarele, în afara celui defect. (Mod de service ⇒ Mod de autentificare).

Material	Atenuare
Lemn, gips, sticlă (neacoperit, fără meta)	0 - 10 %
Cărămidă, lemn presat stratificat	5 - 35 %
Beton armat cu fier	10 - 90 %
Metal, materiale cașerate cu aluminiu	90 - 100 %

Magnet:



Pentru activarea modului de service magnetul trebuie să acționeze contactul REED (din spatele rozetei). (vezi pag. 198/199 Mod de service).

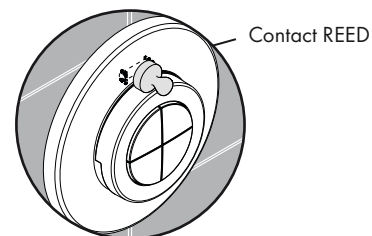

Raindance Rainfall

28411000

iControl mobile

15940180 / 15942000

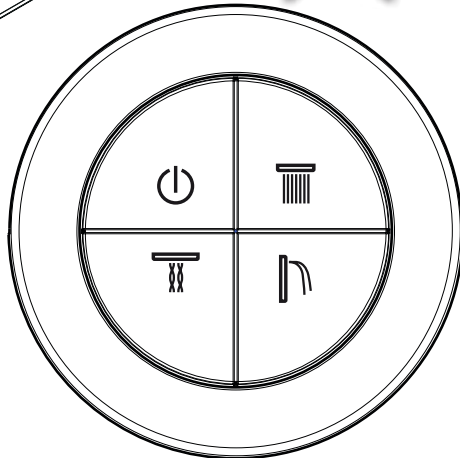
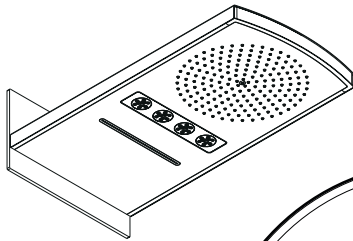

Raindance Rainfall

28411000

iControl mobile

15941180 / 15944000

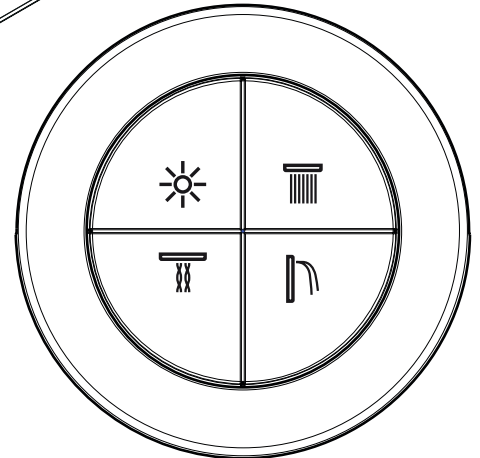
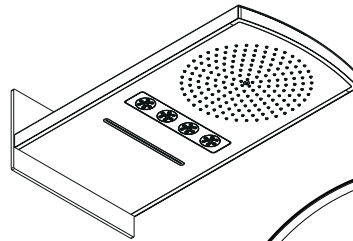

Raindance Rainmaker

28403000

iControl mobile

15940180 / 15943000

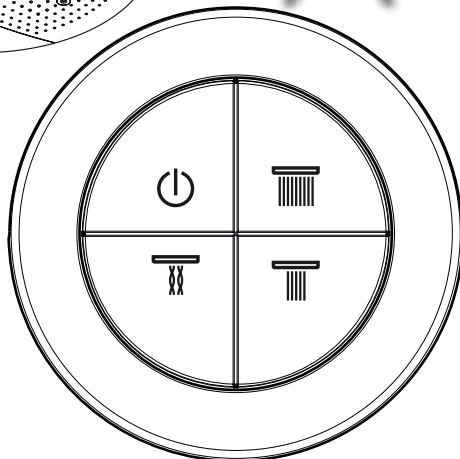
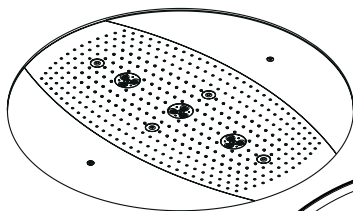

Raindance Rainmaker

28404000

iControl mobile

15941180 / 15945000

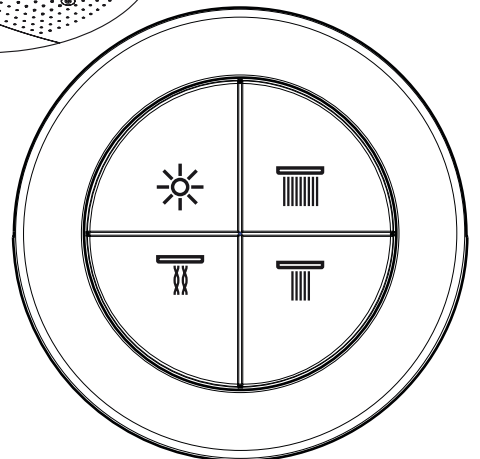
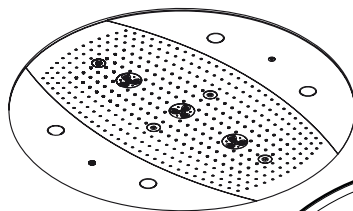

Toate dispozitivele oprite



Rain



Whirl



Rainflow



Lumină



Rain AIR XXL



Rain AIR

Montare vezi pag. 303

Pornire și oprire duș și lumină:

(Funcționare standard cu lumină)

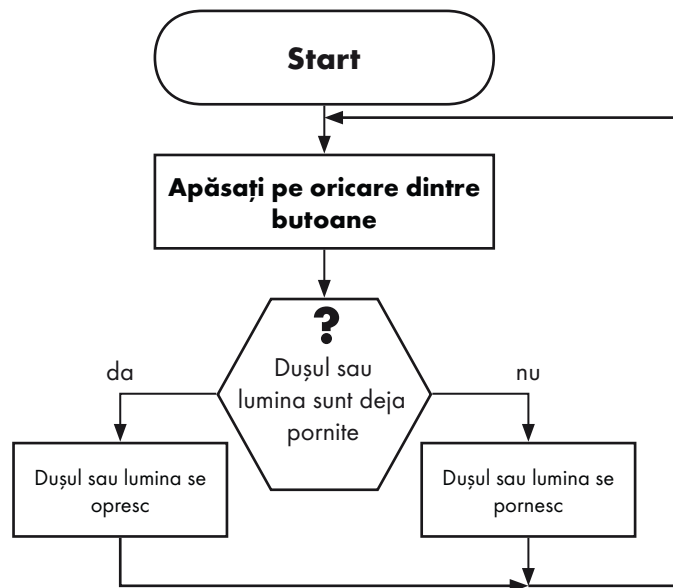

Pornire și oprire duș:

(Funcționare standard fără lumină)

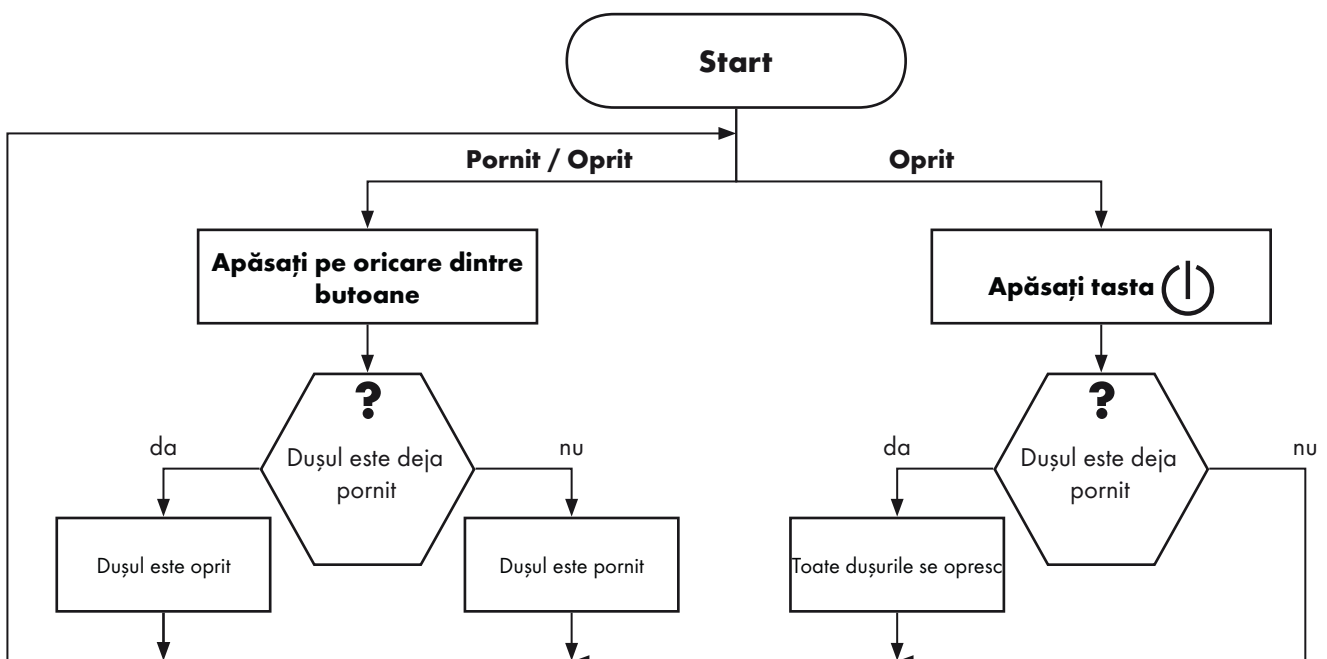

Română
Domeniu utilizatori

Raindance Rainfall
28411000

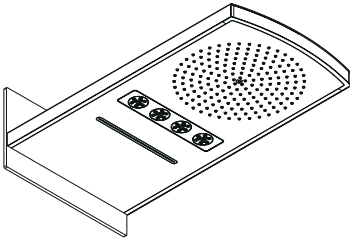

Mod de funcționare

Observație:
Toate dușurile trebuie să fie oprite

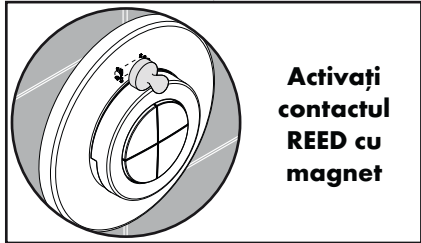

Mod de service

Observație:
Lumina / Ștecherul de codificare pâlpâie de 4 ori

Observație:
Lumina / Ștecherul de codificare se stinge

Observație:
Lumina / Ștecherul de codificare pâlpâie de 2 ori

< 15 sec.

> 15 sec.

Apăsați de două ori butonul sau

Apăsați de două ori butonul

Mod de funcționare perioadă maximă

Observație:
Lumina / Ștecherul de codificare pâlpâie la fiecare 1 sec.

Mod de duș

Observație:
Lumina / Ștecherul de codificare pâlpâie la fiecare 2 sec.

< 15 sec.

> 15 sec.

< 15 sec.

> 15 sec.

Apăsați butonul sau

Apăsați tasta

Apăsați tasta

Apăsați tasta

Apăsați tasta

Apăsați tasta

Timpi de funcționare:
Duș: 30 s
Lumină: 30 min

Standard:
Timpi de funcționare:
Duș: 60 s
Lumină: 30 min

Timpi de funcționare::
Duș: 180 s
Lumină: 30 min

Timpi de funcționare:
Duș + Lumină:
Nedeterminat

Standard
Pot fi pornite max. 2 dușuri

Confort 1:
Pot fi pornite simultan toate dușurile

Română
Domeniu utilizatori

Raindance Rainmaker
28403000 / 28404000

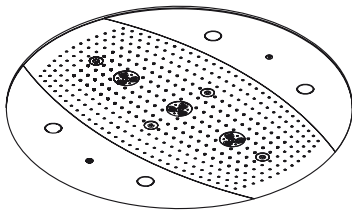

Mod de funcționare

Observație:
Toate dușurile trebuie să fie oprite

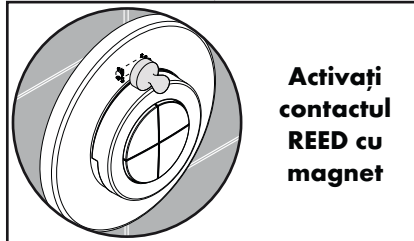

Observație:
Lumina / Ștecherul de codificare se stinge



Mod de service

Observație:
Lumina / Ștecherul de codificare pâlpâie de 4 ori

Observație:
Lumina / Ștecherul de codificare pâlpâie de 2 ori

< 15 sec.

> 15 sec.

Apăsați de două ori butonul  sau 

Apăsați de două ori butonul 

Mod de funcționare perioadă maximă

Observație:
Lumina / Ștecherul de codificare pâlpâie la fiecare 1 sec.

Mod de duș





Observație:
Lumina / Ștecherul de codificare pâlpâie la fiecare 2 sec.

< 15 sec.

> 15 sec.

< 15 sec.

> 15 sec.

Apăsați butonul  sau 	Apăsați tasta 	Apăsați tasta 	Apăsați tasta 
---	---	---	---

Apăsați tasta 	Apăsați tasta 	Apăsați tasta 
---	---	---

Timpi de funcționare: Duș: 30 s Lumină: 30 min	Standard: Timpi de funcționare: Duș: 60 s Lumină: 30 min	Timpi de funcționare:: Duș: 180 s Lumină: 30 min	Timpi de funcționare: Duș + Lumină: Nedeterminat
---	---	---	---

Standard Pot fi pornite max. 2 dușuri	Confort 1: Pot fi pornite simultan toate dușurile	Confort 2: O cantitate mai mare de apă este necesară numai în cazul Rainmaker
---	---	---

Română

Domeniu specialiști

Raindance Rainfall
28411000

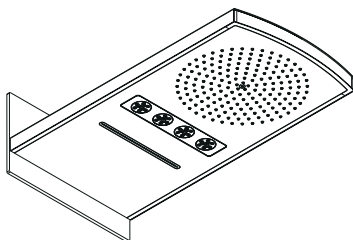

Mod de funcționare

Observație:
Toate dușurile trebuie să fie oprite

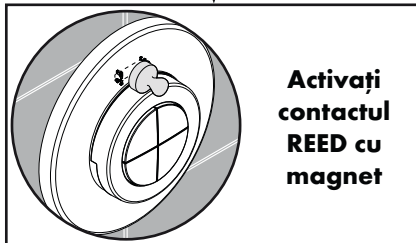

Activați contactul REED cu magnet

Mod de service

Observație:
Lumina / Ștecherul de codificare pâlpâie de 4 ori

Observație:
Lumina / Ștecherul de codificare pâlpâie de 2 ori

Observație:
Lumina / Ștecherul de codificare se stinge

< 15 sec.

> 15 sec.

Apăsați o dată oricare dintre butoane

Apăsați de două ori butonul

Apăsați de două ori butonul

Mod de autentificare

Mod de ștergere

Mod de prezentare

?
Emitătorul este recunoscut

da

nu

Observație:
Lumina / Ștecherul de codificare pâlpâie la fiecare 0,5 sec.

Observație:
Lumina / Ștecherul de codificare pâlpâie la fiecare 4 sec.

Observație:
Lumina / Ștecherul de codificare pâlpâie de 1 ori

?
Numărul emițătoarelor recunoscute. ≤ 3 piese

da

nu

Observație:
Primul emițător recunoscut se va șterge

< 15 sec.

> 15 sec.

< 15 sec.

> 15 sec.

Apăsați butonul
sau

Apăsați tasta

Apăsați butonul
sau

Apăsați tasta

Apăsați tasta

Se vor șterge toate emițătoarele

Se va șterge emițătorul utilizat

Se pornește prezentarea 1

Se pornește prezentarea 2

Se pornește prezentarea 3

Observație:
Lumina / Ștecherul de codificare pâlpâie de 3 ori
Emițătorul nou se va acorda și se va salva

Apăsați pe oricare dintre butoane

Observație:
Toate dușurile se opresc

Română

Domeniu specialiști

Raindance Rainmaker
28403000 / 28404000

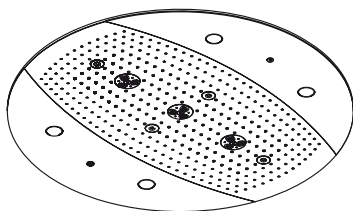

Mod de funcționare

Observație:
Toate dușurile trebuie să fie oprite

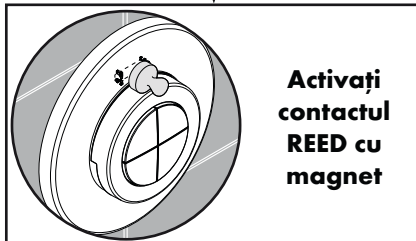

Activați contactul REED cu magnet

Mod de service

Observație:
Lumina / Ștecherul de codificare pâlpâie de 4 ori

Observație:
Lumina / Ștecherul de codificare pâlpâie de 2 ori

Observație:
Lumina / Ștecherul de codificare se stinge

< 15 sec.

> 15 sec.

Apăsați o dată oricare dintre butoane

Apăsați de două ori butonul

Apăsați de două ori butonul

Mod de autentificare

Mod de ștergere

Mod de prezentare

?
Emițătorul este recunoscut

da

nu

Observație:
Lumina / Ștecherul de codificare pâlpâie la fiecare 0,5 sec.

Observație:
Lumina / Ștecherul de codificare pâlpâie la fiecare 4 sec.

Observație:
Lumina / Ștecherul de codificare pâlpâie de 1 ori

?
Numărul emițătoarelor recunoscute. ≤ 3 piese

da

nu

Observație:
Primul emițător recunoscut se va șterge

< 15 sec.

> 15 sec.

< 15 sec.

> 15 sec.

Apăsați butonul
sau

Apăsați tasta

Apăsați butonul
sau

Apăsați tasta

Apăsați tasta

Se vor șterge toate emițătoarele

Se va șterge emițătorul utilizat

Se pornește prezentarea 1

Se pornește prezentarea 2

Se pornește prezentarea 3

Observație:
Lumina / Ștecherul de codificare pâlpâie de 3 ori
Emițătorul nou se va acorda și se va salva

Apăsați pe oricare dintre butoane

Observație:
Toate dușurile se opresc

Πρότυπα και οδηγίες:

Η εφαρμογή του προϊόντος πρέπει να ακολουθεί τις εξής οδηγίες:

- EN 15200
- EN 60335-2-105



Υποδείξεις ασφαλείας:

- Το προϊόν επιτρέπεται να χρησιμοποιείται μόνο σαν μέσο λουτρού, υγιεινής και καθαρισμού του σώματος.
- Τα παιδιά δεν επιτρέπεται να χρησιμοποιούν το σύστημα του ντους χωρίς επίβλεψη.
- Παιδιά ή ενήλικες με μειωμένες σωματικές, διανοητικές και/ή αισθητήριες ανεπάρκειες δεν επιτρέπεται να χρησιμοποιούν το σύστημα ντους χωρίς επιτήρηση. Άτομα υπό την επήρεια οινοπνεύματος ή ναρκωτικών δεν επιτρέπεται να χρησιμοποιούν σε καμία περίπτωση το
- Η επαφή δέσμης νερού του ντους με ευαίσθητες περιοχές του σώματος (π.χ. μάτια) πρέπει να αποφεύγεται. Διατηρείτε επαρκή απόσταση ανάμεσα στο ντους και το σώμα.
- Οι διαφορές της πίεσης μεταξύ της σύνδεσης κρύου και ζεστού νερού θα πρέπει να αντισταθμίζονται.



Ηλεκτρική παροχή:

- Οι εργασίες εγκατάστασης και ελέγχου πρέπει να διενεργούνται από έναν εγκεκριμένο ηλεκτρολόγο, λαμβάνοντας υπόψη τις οδηγίες VDE 0100 Μέρος 701 και IEC 60364-7-701.
- Για την ηλεκτρική σύνδεση απαιτείται μόνο μία πρίζα. Η τροφοδοσία ρεύματος γίνεται μέσω ενός εξωτερικού μετασχηματιστή.
- Πολύ κοντά στην εγκατάσταση δεν επιτρέπεται να βρίσκονται εύφλεκτα υλικά.
- Η θερμοκρασία περιβάλλοντος δεν επιτρέπεται να υπερβαίνει τους 50 °C
- Η συνολική τροφοδοσία ρεύματος γίνεται μέσω μίας σύνδεσης εναλλασσόμενου ρεύματος 230V/N/PE/50Hz.
- Η ασφάλιση θα πρέπει να πραγματοποιείται μέσω διάταξης προστασίας ρεύματος διαρροής (RCD/ FI) με παραμένον ρεύμα ≤ 30 mA.
- Εάν είναι απαραίτητη μία εξίσωση δυναμικού, αυτή θα πρέπει να γίνει από τον πελάτη.
- Στην ηλεκτρική εγκατάσταση πρέπει να τηρούνται οι αντίστοιχες προδιαγραφές της εκάστοτε ένωσης ηλεκτρολόγων, της εκάστοτε χώρας και εταιρείας ηλεκτρικού ρεύματος στην εκάστοτε έγκυρη έκδοση
- Το προϊόν πρέπει να μπορεί να απομονώνεται από το δίκτυο. Είτε με μία ελεύθερα προσβάσιμη φίσα είτε με έναν πολυπολικό διακόπτη κατά EN 60335-1 παρ. 24.3.



Συναρμολόγηση: (βλ. Σελίδα 303)

- Προσοχή! Η μπαταρία πρέπει να τοποθετηθεί, να πλυθεί και να ελεγχθεί με βάση τους ισχύοντες κανόνες υδραυλικής τέχνης (Εγκατάσταση σύμφωνα με το πρότυπο EN 1717) Βλέπε Οδηγίες συναρμολόγησης:
Raindance Rainfall 28411000
Raindance Rainmaker 28403000 / 28404000 / 28417000 / 28418000
- Όλες οι εργασίες επιτρέπεται να εκτελούνται μόνο όταν δεν υπάρχει τάση.
- Το κύριο σώμα του κουτιού 15941180 μπορεί να τοποθετηθεί μόνο σε κάθετη θέση!
Συναρμολόγηση με ρυθμιστικό δακτύλιο (A) είναι δυνατή μόνο στην μπροστινή και μεσαία περιοχή!
- Όλα τα εξαρτήματα πρέπει να παραμένουν προσβάσιμα.

Τεχνικά Χαρακτηριστικά:

Λειτουργία πίεσης::	έως 1 MPa
Συνιστώμενη λειτουργία πίεσης:	0,1 - 0,5 MPa
Πίεση ελέγχου:	1,6 MPa
(1 MPa = 10 bar = 147 PSI)	
Θερμοκρασία ζεστού νερού::	έως 80 °C
Συνιστώμενη θερμοκρασία ζεστού νερού:	65 °C
Διαστάσεις σύνδεσης:	G 3/4
Συνδέσεις Είσοδος:	Ανάμικτο νερό
Ελεύθερη ροή στα 0,3 MPa:	
1 Κατανάλωση:	35 l/min
2 Κατανάλωση:	45 l/min



αξισουάρ: (βλ. Σελίδα 204)



Διαστάσεις: (βλ. Σελίδα 292)



Παραδείγματα συναρμολόγησης Raindance Rainfall: (βλ. Σελίδα 295)



Παραδείγματα συναρμολόγησης Raindance Rainmaker: (βλ. Σελίδα 299)



Χειρισμός: (βλ. Σελίδα 206)

- Σε περίπτωση διακοπής της τάσης δικτύου 230 V δεν μπορεί να χρησιμοποιηθεί το σύστημα ντους.
- Το προϊόν δεν είναι κατάλληλο για χρήση σε ατμόλουτρο!



Καθαρισμός Φίλτρο συλλογής ακαθαρσιών: (βλ. Σελίδα 309)

Ανταλλακτικά (βλ. Σελίδα 311)

Ελληνικά Τεχνικές πληροφορίες

Βλάβη	Αιτία	Διόρθωση
Καμία λειτουργία	<ul style="list-style-type: none"> - Καμία τροφοδοσία τάσης - Ο μετασχηματιστής του βασικού σετ είναι χαλασμένος - Ο δέκτης βρίσκεται σε ακατάλληλη θέση / έχει χαλάσει - Ο πομπός δεν πέρασε από διαδικασία εκμάθησης / είναι χαλασμένος 	<ul style="list-style-type: none"> - Εξασφαλίστε την τροφοδοσία τάσης - Αντικαταστήστε τον μετασχηματιστή - Αλλάξτε τη θέση του δέκτη ή αντικαταστήστε τον δέκτη - Ο δέκτης να υποστεί διαδικασία εκμάθησης / να αντικατασταθεί
Η κατάσταση λειτουργίας δεν ρυθμίζεται	<ul style="list-style-type: none"> - Η επαφή Reed δεν βρίσκεται σε κατάλληλη θέση πίσω από τη ροζέτα - Η επαφή Reed είναι λάθος 	<ul style="list-style-type: none"> - Τοποθετήστε την επαφή Reed στη ροζέτα - Αντικαταστήστε τον αγωγό σύνδεσης της μαγνητικής βαλβίδας
Καμία λειτουργία φωτισμού	<ul style="list-style-type: none"> - Ο μετασχηματιστής του Rainmaker δεν έχει τοποθετηθεί σωστά / έχει τοποθετηθεί λάθος - Οι παροχές του ρελέ φωτισμού είναι λανθασμένες / χαλασμένες 	<ul style="list-style-type: none"> - Εξασφαλίστε την τροφοδοσία τάσης του μετασχηματιστή / αντικαταστήστε τον μετασχηματιστή - Ελέγξτε τις συνδέσεις και το ρελέ φωτισμού / αντικαταστήστε
Οι καταναλωτές απενεργοποιούνται αυτόνομα	<ul style="list-style-type: none"> - Έχει ρυθμιστεί χρονικό όριο λειτουργίας στο πρόγραμμα 	<ul style="list-style-type: none"> - Αυξήστε τον χρόνο διαδρομής σε αδράνεια στη λειτουργία service / κλείστε τον
Η μπαταρία δεν είναι στεγανή	<ul style="list-style-type: none"> - Η μαγνητική βαλβίδα είναι ακάθαρτη / χαλασμένη 	<ul style="list-style-type: none"> - Καθαρίστε τις μεμβράνες της μαγνητικής βαλβίδας / αντικαταστήστε τις
Πολύ χαμηλή ροή	<ul style="list-style-type: none"> - Το φίλτρο ακαθαρσιών στην εισαγωγή είναι ακάθαρτο 	<ul style="list-style-type: none"> - Καθαρίστε / αλλάξτε το φίλτρο συλλογής ακαθαρσιών

Σύμβολα

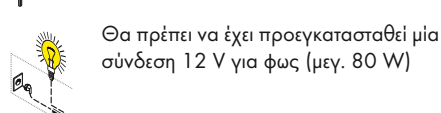
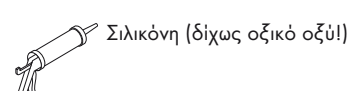
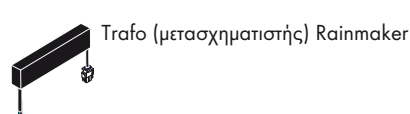
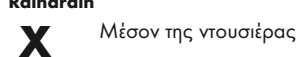
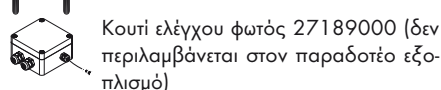
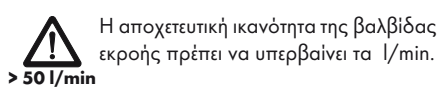
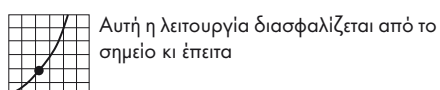
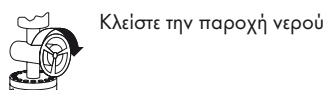
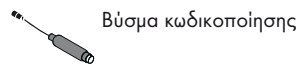
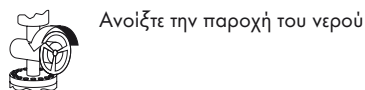
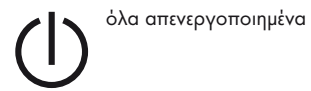
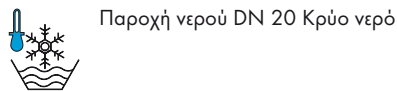
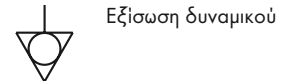
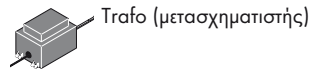
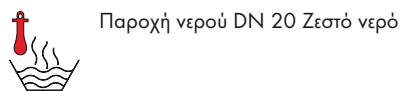

Συναρμολόγηση βλ. Σελίδα 303

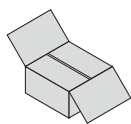

Ελληνικά αξεσουάρ

Trafo (μετασχηματιστής):

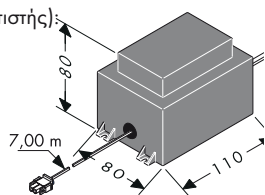

Η ισχύς του εξωτερικού τροφοδοτικού μετασχηματιστή είναι 50 VA. Ο μετασχηματιστής πρέπει να είναι εγκατεστημένος σε στεγνή περιοχή (ζώνη προστασίας 3). Ο τροφοδοτικός μετασχηματιστής μπορεί να τοποθετηθεί μαζί με τον δέκτη σε ένα πλαστικό κέλυφος, λαμβάνοντας υπόψη την οδηγία EN/IEC 60335-1. (διαστάσεις περ. 250 x 160 x 92 mm, δεν περιλαμβάνεται στο παραδοτέο υλικό.) Το παρεχόμενο καλώδιο καθιστά δυνατή την τοποθέτηση του τροφοδοτικού μετασχηματιστή σε απόσταση έως 7 m από τον δέκτη. Για τον σκοπό αυτό πρέπει να προβλεφθεί ένας κενός αγωγός καλωδίων EN35 (δεν περιλαμβάνεται στο παραδοτέο υλικό). Ο κενός αγωγός καλωδίων πρέπει να στερεώνεται τουλάχιστον κάθε 500 mm και η ακτίνα κάμψης

πρέπει να είναι μεγαλύτερη από 100 mm.

Το μήκος του δευτερεύοντα αγωγού του τροφοδοτικού μετασχηματιστή που είναι 7 m περίπου δεν επιτρέπεται να μειωθεί. Το μήκος του αγωγού που δεν θα χρησιμοποιηθεί πρέπει να τοποθετηθεί κοντά στον τροφοδοτικό μετασχηματιστή ασφαλείας. Ένας ελαττωματικός αγωγός σύνδεσης δεν επιτρέπεται να αντικατασταθεί. Σε αυτήν την περίπτωση ο μετασχηματιστής δεν επιτρέπεται πλέον να χρησιμοποιηθεί.

Ένας ελαττωματικός αγωγός σύνδεσης δεν επιτρέπεται να αντικατασταθεί. Εάν η γραμμή σύνδεσης στο δίκτυο παρουσιάσει βλάβη, θα πρέπει να αντικατασταθεί μαζί με τον μετασχηματιστή από έναν ειδικό ηλεκτρολόγο.

Ρελέ φώτων:

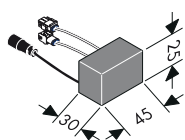

(μόνο στην έκδοση με ενσωματωμένο φως)

Το ρελέ των φώτων επιτρέπεται να φορτιστεί έως 12 V AC / 80 W.

Δεν επιτρέπεται η λειτουργία στο δίκτυο 230 V.

Κουτί ελέγχου φωτός: 27189000

(δεν περιλαμβάνεται στον παραδοτέο εξοπλισμό)

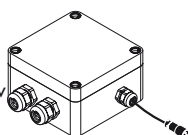

(iControl mobile 15944000)

Το σύστημα ελέγχου φωτισμού πρέπει να συνδεθεί στους τύπους με εξωτερική πηγή φωτισμού.

Το σύστημα ελέγχου φωτισμού πρέπει να είναι πάντα προσβάσιμο.

Βύσμα κωδικοποίησης:

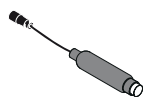

(Raindance Rainfall 28411000 / Raindance Rainmaker 28403000)

Το βύσμα κωδικοποίησης πρέπει να συνδέεται στις εκδόσεις χωρίς φωτισμό.

Εάν στις εκδόσεις χωρίς φωτισμό είναι ενεργοποιημένη η κατάσταση σέρβις, η φωτοδίοδος του βύσματος κωδικοποίησης επισημαίνει οπτικά τα μηνύματα ανάδρασης.

Η φίσα κωδικοποίησης πρέπει να είναι πάντα προσβάσιμη.

Αγωγός σύνδεσης Συγκρότημα μαγνητικών βαλβίδων / Αγωγός σύνδεσης Φως:



Το μήκος του αγωγού της μαγνητικής βαλβίδας με 7,50 m καθώς και το μήκος του αγωγού φωτισμού με 10,00 m δεν επιτρέπεται να μειωθεί. Το μήκος του αγωγού που δεν θα χρησιμοποιηθεί πρέπει να τοποθετηθεί κοντά στον δέκτη.

Τα καλώδια του αγωγού της μαγνητικής βαλβίδας και του φωτισμού επιτρέπεται να τοποθετηθούν μόνο στον παρεχόμενο κενό αγωγό καλωδίων (EN 20).

Ο κενός αγωγός καλωδίων πρέπει να στερεώνεται τουλάχιστον κάθε 500 mm και η ακτίνα κάμψης πρέπει να είναι μεγαλύτερη από 100 mm.

Προσοχή: Στους κενούς αγωγούς καλωδίων για τον αγωγό της μαγνητικής βαλβίδας και τον αγωγό φωτισμού δεν επιτρέπεται να τοποθετηθούν ηλεκτρικά καλώδια, τα οποία φέρουν τάση μεγαλύτερη από 12V.

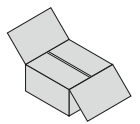

Δέκτης:

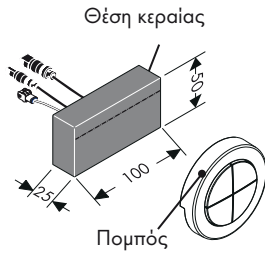

Ο δέκτης θα πρέπει κατά προτίμηση να τοποθετηθεί στον ίδιο χώρο με το σύστημα ντους. Εάν αυτό δεν είναι δυνατό, ο δέκτης μπορεί να τοποθετηθεί και σε χώρο, ο οποίος γειτονεύει με το σύστημα ντους. Ο δέκτης δεν επιτρέπεται να εγκατασταθεί σε μεταλλικό κέλυφος, διότι σε αυτήν την περίπτωση απομονώνονται τα ραδιοσήματα του πομπού. Επίσης θα πρέπει να δοθεί προσοχή, ώστε να υπάρχουν όσο το δυνατόν λιγότερα μεταλλικά αντικείμενα που θα εμποδίζουν τα σήμ

Για την ιδανική αναγνώριση των ραδιοσημάτων η κεραία του δέκτη θα πρέπει να είναι στραμμένη όσο γίνεται προς τον πομπό.

Πομπός:



Κατά την παράδοση ο πομπός είναι ήδη ρυθμισμένος επάνω στον δέκτη. Μέσω των κοινών σειριακών αριθμών μπορεί να γίνει η αντιστοίχιση του πομπού με τον δέκτη. Πρόσθετοι ή εκ των υστέρων αγορασμένοι πομποί απαιτούν ρύθμιση. Υπάρχει δυνατότητα ρύθμισης ή αποθήκευσης σε έναν δέκτη έως και τεσσάρων πομπών. (βλ. Σελίδα 210/211 Κατάσταση εγγραφής). Η ραδιοσυχνότητα του πομπού είναι 868,3 MHz.

Σημείωση: Ο δέκτης και ο πομπός έχουν εμβέλεια περίπου 10 m. Η εμβέλεια εξαρτάται από το πόσο έντονα αποσβένονται τα ραδιοσήματα μεταξύ πομπού και δέκτη.

Σημείωση: Για λόγους ασφαλείας χρησιμοποιείτε τον πομπό μόνο μέσα στο οπτικό πεδίο του συστήματος ντους. Αλλιώς μπορεί να να ενεργοποιηθεί κατά λάθος το νερό.

Σημείωση: Ορθός τρόπος εργασίας σε περίπτωση αντικατάστασης ενός ελαττωματικού πομπού με έναν καινούργιο:

1. Διαγραφή όλων των πομπών. (Κατάσταση εγγραφής ⇒ Κατάσταση διαγραφής).
2. Εκ νέου ρύθμιση όλων των πομπών, εκτός από τον ελαττωματικό. (Κατάσταση οέρβις ⇒ Κατάσταση εγγραφής).

Υλικό	Απόσβεση
Ξύλο, γύψος, γυαλί (μη επικρισμένα, χωρίς μέταλλο)	0 - 10 %
Οπτόπλινθοι, μοριοσανίδες	5 - 35 %
Σκυρόδεμα με οπλισμό από σίδηρο	10 - 90 %
Μέταλλα, επένδυση αλουμινίου	90 - 100 %

Μαγνήτης:



Για την ενεργοποίηση του τρόπου λειτουργίας Service πρέπει ο μαγνήτης να ενεργοποιήσει τη REED-επαφή (πίσω από τη ροζέτα). (βλ. Σελίδα 208/209, Κατάσταση οέρβις).

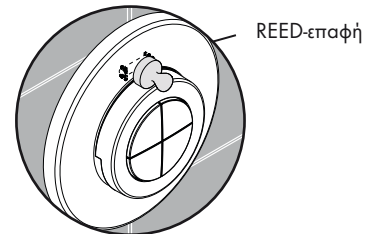

Ελληνικά Χειρισμός

Raindance Rainfall

28411000

iControl mobile

15940180 / 15942000

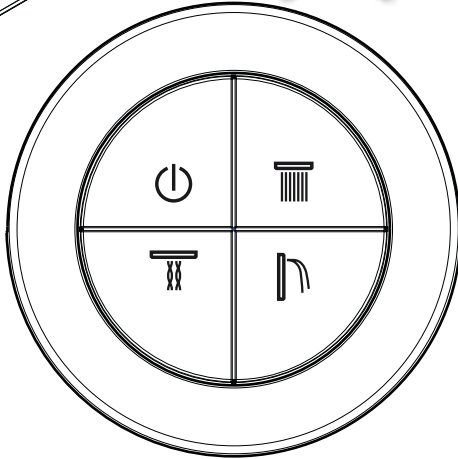
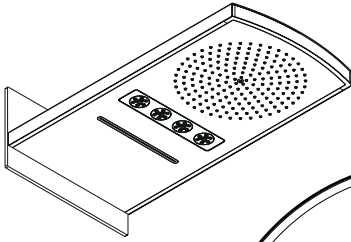

Raindance Rainfall

28411000

iControl mobile

15941180 / 15944000

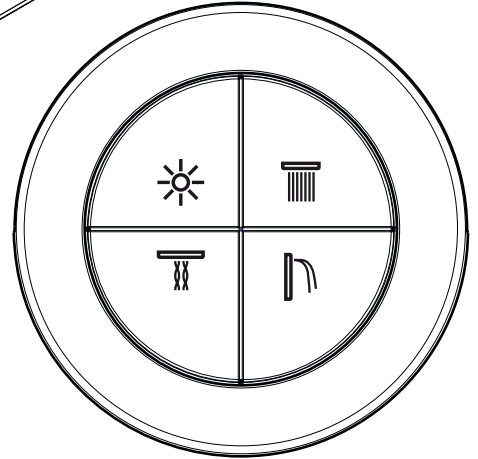
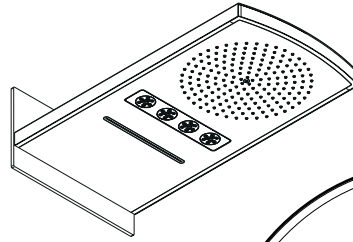

Raindance Rainmaker

28403000

iControl mobile

15940180 / 15943000

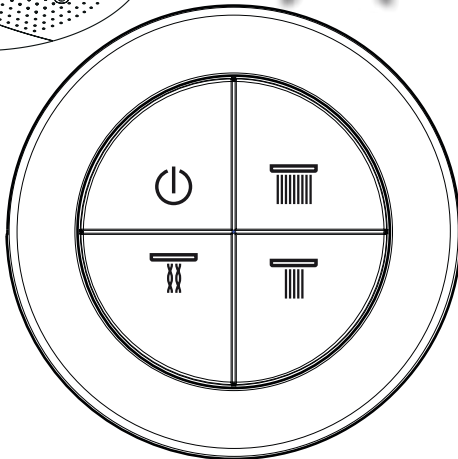
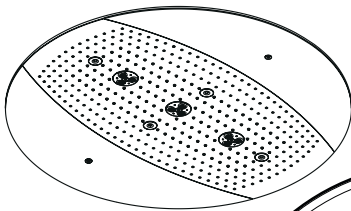

Raindance Rainmaker

28404000

iControl mobile

15941180 / 15945000

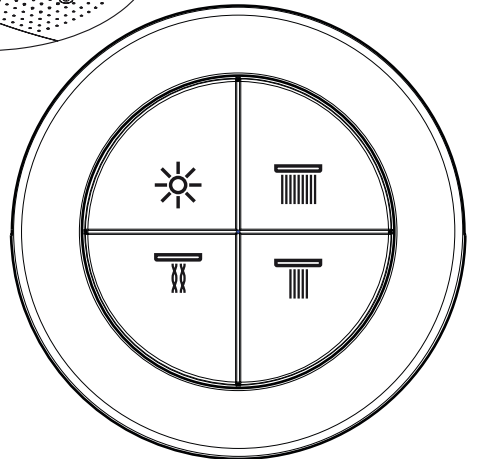
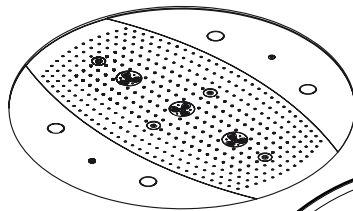

όλα απενεργοποιημένα



Rain



Whirl



Rainflow



Φως



Rain AIR XXL



Rain AIR

Συναρμολόγηση βλ. Σελίδα 303

Ενεργοποίηση και απενεργοποίηση ψεκαστήρων ντους και φωτισμού:
(Βασική λειτουργία με φωτισμό)

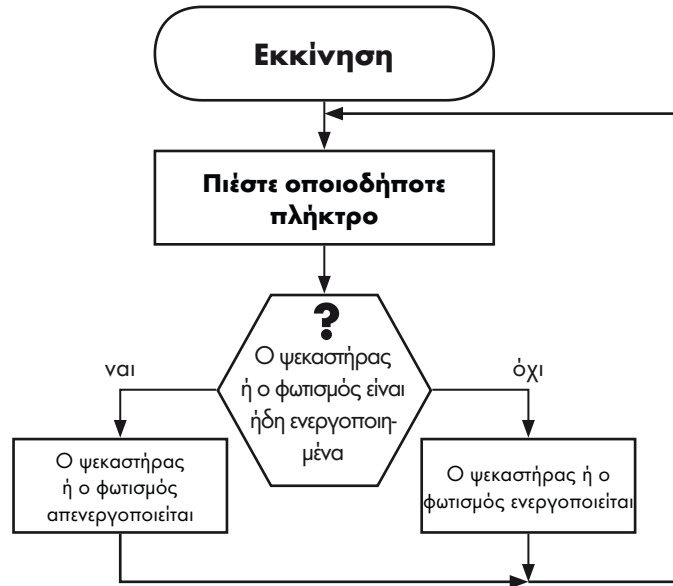

Ενεργοποίηση και απενεργοποίηση ψεκαστήρων:
(Standardfunktion ohne Licht)

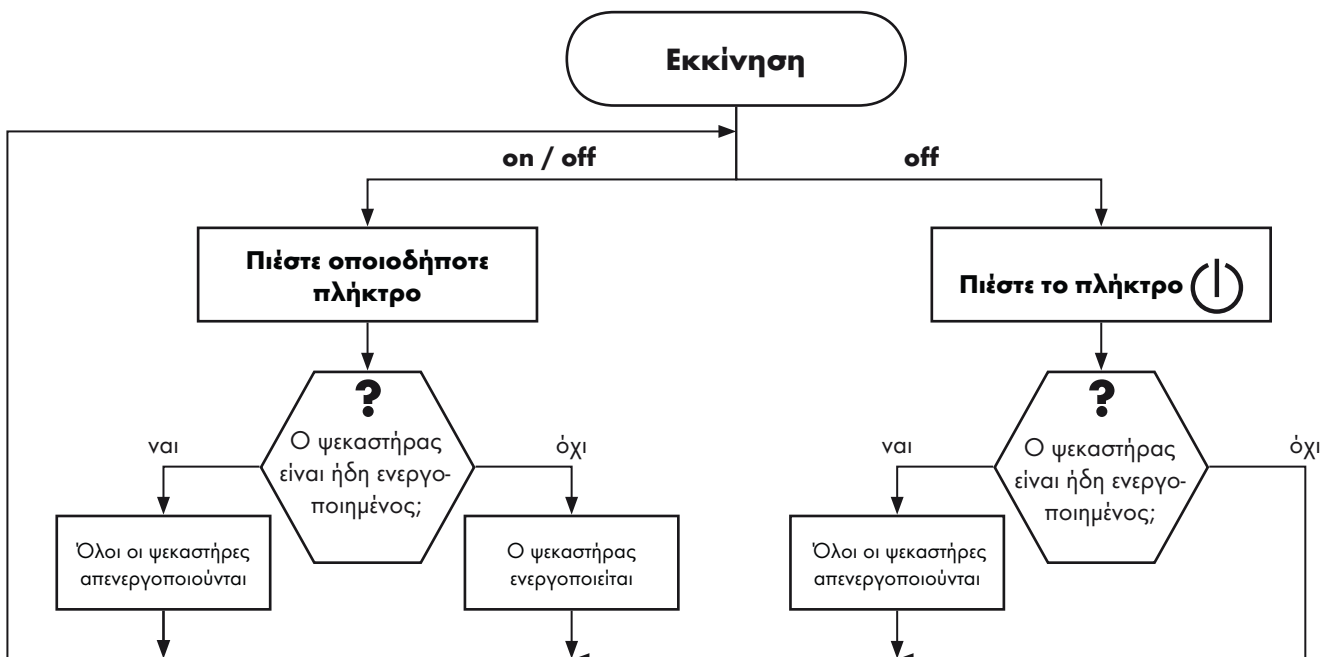

Ελληνικά Επίπεδο χρήστη

Raindance Rainfall
28411000

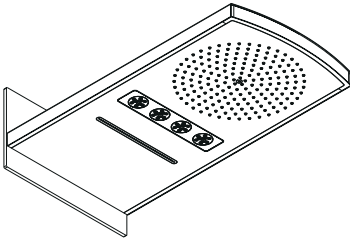

Κατάσταση λειτουργίας

Σημείωση:
Όλοι οι ψεκαστήρες πρέπει να είναι απενεργοποιημένοι



Κατάσταση οέρβις

Σημείωση:
Φως / βύσμα κωδικοποίησης αναβοσβήνει 4x

Σημείωση:
Φως / βύσμα κωδικοποίησης αναβοσβήνει 2x

Σημείωση:
Φως / βύσμα κωδικοποίησης σβήνει

< 15 δευτ.

> 15 δευτ.

Πιέστε δύο φορές το πλήκτρο  ή 

 Πιέστε δύο φορές το πλήκτρο

Κατάσταση μέγιστης διάρκειας λειτουργίας

Σημείωση:
Το φως / βύσμα κωδικοποίησης αναβοσβήνει με ρυθμό 1 ΔΕΥΤ.

Κατάσταση λειτουργίας ψεκαστήρων

Σημείωση:
Το φως / βύσμα κωδικοποίησης αναβοσβήνει με ρυθμό 2 ΔΕΥΤ.

< 15 δευτ.

> 15 δευτ.

< 15 δευτ.

> 15 δευτ.

Πιέστε το πλήκτρο  ή 

 Πιέστε το πλήκτρο

 Πιέστε το πλήκτρο

 Πιέστε το πλήκτρο

Πιέστε το πλήκτρο  ή 

 Πιέστε το πλήκτρο

Χρονικά διαστήματα:
Ψεκαστήρες: 30 s
Φως: 30 min

Βασική λειτουργία:
Χρονικά διαστήματα:
Ψεκαστήρες: 60 s
Φως: 30 min

Χρονικά διαστήματα:
Ψεκαστήρες: 180 s
Φως: 30 min

Χρονικά διαστήματα:
Ψεκαστήρες + φως: μόνιμα

Βασική λειτουργία
μπορούν να ενεργοποιηθούν έως 2 ψεκαστήρες

Λειτουργία άνεσης 1:
όλοι οι ψεκαστήρες μπορούν να ενεργοποιηθούν ταυτόχρονα

Ελληνικά Επίπεδο χρήστη

Raindance Rainmaker
28403000 / 28404000

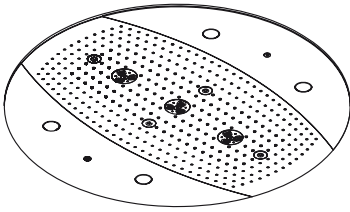

Κατάσταση λειτουργίας

Σημείωση:
Όλοι οι ψεκαστήρες πρέπει να είναι απενεργοποιημένοι

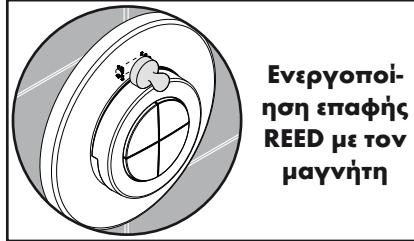

Κατάσταση οέρβις



Σημείωση:
Φως / βύσμα κωδικοποίησης αναβοσβήνει 4x

Σημείωση:
Φως / βύσμα κωδικοποίησης αναβοσβήνει 2x

Σημείωση:
Φως / βύσμα κωδικοποίησης σβήνει

< 15 δευτ.

> 15 δευτ.

Πιέστε δύο φορές το πλήκτρο  ή 

Πιέστε δύο φορές το πλήκτρο 

Κατάσταση μέγιστης διάρκειας λειτουργίας

Σημείωση:
Το φως / βύσμα κωδικοποίησης αναβοσβήνει με ρυθμό 1 ΔΕΥΤ.

Κατάσταση λειτουργίας ψεκαστήρων

Σημείωση:
Το φως / βύσμα κωδικοποίησης αναβοσβήνει με ρυθμό 2 ΔΕΥΤ.

< 15 δευτ.

> 15 δευτ.

< 15 δευτ.

> 15 δευτ.

Πιέστε το πλήκτρο  ή 

Πιέστε το πλήκτρο 

Πιέστε το πλήκτρο 

Πιέστε το πλήκτρο 

Πιέστε το πλήκτρο  ή 

Πιέστε το πλήκτρο 

Πιέστε το πλήκτρο 

Χρονικά διαστήματα:
Ψεκαστήρες: 30 s
Φως: 30 min

Βασική λειτουργία:
Χρονικά διαστήματα:
Ψεκαστήρες: 60 s
Φως: 30 min

Χρονικά διαστήματα:
Ψεκαστήρες: 180 s
Φως: 30 min

Χρονικά διαστήματα:
Ψεκαστήρες + φως: μόνιμα

Βασική λειτουργία
μπορούν να ενεργοποιηθούν έως 2 ψεκαστήρες

Λειτουργία άνεσης 1:
όλοι οι ψεκαστήρες μπορούν να ενεργοποιηθούν ταυτόχρονα

Λειτουργία άνεσης 2:
Μεγαλύτερη ποσότητα νερού, απαιτείται μόνο στην λειτουργία ντους Rainmaker

Ελληνικά
Επίπεδο ειδικού τεχνικού

Raindance Rainfall
28411000

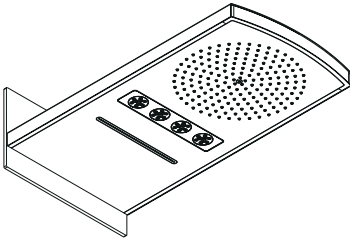

Κατάσταση λειτουργίας

Σημείωση:
Όλοι οι ψεκαστήρες πρέπει να είναι απενεργοποιημένοι



Ενεργοποίηση επαφής REED με τον μαγνήτη

Κατάσταση οέρβις

Σημείωση:
Φως / βύσμα κωδικοποίησης αναβοσβήνει 4x

Σημείωση:
Φως / βύσμα κωδικοποίησης αναβοσβήνει 2x

Σημείωση:
Φως / βύσμα κωδικοποίησης σβήνει

< 15 δευτ.

> 15 δευτ.

Πιέστε 1 x οποιοδήποτε πλήκτρο

Κατάσταση εγγραφής

?
Οι πομπές είναι γνωστές;

?
Αριθμός των γνωστών πομπών; ≤ 3 τεμάχια

Σημείωση:
Φως / βύσμα κωδικοποίησης αναβοσβήνει 1x

Σημείωση:
Ο παλιότερος γνωστός πομπός διαγράφεται

Σημείωση:
Φως / βύσμα κωδικοποίησης αναβοσβήνει 3x
Ρυθμίζεται ή αποθηκεύεται καινούργιος πομπός

Πιέστε δύο φορές το πλήκτρο

Κατάσταση διαγραφής

Σημείωση:
Το φως / βύσμα κωδικοποίησης αναβοσβήνει με ρυθμό 0,5 δευτ.

< 15 δευτ.

> 15 δευτ.

Πιέστε το πλήκτρο
ή

Πιέστε το πλήκτρο

όλοι οι πομπός διαγράφονται

ο πομπός που χρησιμοποιήθηκε διαγράφεται

Πιέστε δύο φορές το πλήκτρο

Κατάσταση παρουσίασης

Σημείωση:
Το φως / βύσμα κωδικοποίησης αναβοσβήνει με ρυθμό 4 δευτ.

< 15 δευτ.

> 15 δευτ.

Πιέστε το πλήκτρο
ή

Πιέστε το πλήκτρο

Πιέστε το πλήκτρο

Η παρουσίαση 1 ξεκινάει

Η παρουσίαση 2 ξεκινάει

Η παρουσίαση 3 ξεκινάει

Πιέστε οποιοδήποτε πλήκτρο
Σημείωση:
όλοι οι ψεκαστήρες απενεργοποιούνται

Ελληνικά
Επίπεδο ειδικού τεχνικού

Raindance Rainmaker
28403000 / 28404000

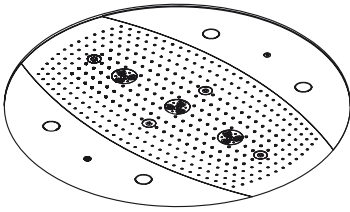

Κατάσταση λειτουργίας

Σημείωση:
Όλοι οι ψεκαστήρες πρέπει να είναι απενεργοποιημένοι



Ενεργοποίηση επαφής REED με τον μαγνήτη

Κατάσταση οέρβις

Σημείωση:
Φως / βύσμα κωδικοποίησης αναβοσβήνει 4x

Σημείωση:
Φως / βύσμα κωδικοποίησης αναβοσβήνει 2x

Σημείωση:
Φως / βύσμα κωδικοποίησης σβήνει

< 15 δευτ.

> 15 δευτ.

Πιέστε 1 x οποιοδήποτε πλήκτρο

Κατάσταση εγγραφής

?
Οι πομπές είναι γνωστές;

?
Αριθμός των γνωστών πομπών; ≤ 3 τεμάχια

Σημείωση:
Φως / βύσμα κωδικοποίησης αναβοσβήνει 1x

Σημείωση:
Ο παλιότερος γνωστός πομπός διαγράφεται

Σημείωση:
Φως / βύσμα κωδικοποίησης αναβοσβήνει 3x
Ρυθμίζεται ή αποθηκεύεται καινούργιος πομπός

Πιέστε δύο φορές το πλήκτρο

Κατάσταση διαγραφής

Σημείωση:
Το φως / βύσμα κωδικοποίησης αναβοσβήνει με ρυθμό 0,5 δευτ.

< 15 δευτ.

> 15 δευτ.

Πιέστε το πλήκτρο
⏻ ή ☀

Πιέστε το πλήκτρο
☀

Όλοι οι πομπός διαγράφονται

ο πομπός που χρησιμοποιήθηκε διαγράφεται

Πιέστε δύο φορές το πλήκτρο

Κατάσταση παρουσίασης

Σημείωση:
Το φως / βύσμα κωδικοποίησης αναβοσβήνει με ρυθμό 4 δευτ.

< 15 δευτ.

> 15 δευτ.

Πιέστε το πλήκτρο
⏻ ή ☀

Πιέστε το πλήκτρο
☀

Πιέστε το πλήκτρο
☀

Η παρουσίαση 1 ξεκινάει

Η παρουσίαση 2 ξεκινάει

Η παρουσίαση 3 ξεκινάει

Πιέστε οποιοδήποτε πλήκτρο
Σημείωση:
Όλοι οι ψεκαστήρες απενεργοποιούνται

Standardi in direktive:

Uporaba proizvoda je zagotovljena z naslednjimi direktivami:

- EN 15200
- EN 60335-2-105



Varnostna opozorila:

- Ta izdelek se sme uporabljati le z namenom umivanja, vzdrževanja higiene in telesne nege.
- Otroci ne smejo brez nadzora uporabljati sistema za prhanje
- Otroci kot tudi odrasle osebe z omejenimi telesnimi, duševnimi in/ali senzoričnimi sposobnostmi ne smejo nenadzorovano uporabljati sistema za prhanje. Osebe, ki so pod vplivom alkohola ali drog, sistema za prhanje ne smejo uporabljati.
- Izogibati se je treba stiku prhalnega curka z občutljivimi deli telesa (npr. očmi). Med telesom in prho mora biti vedno zadosten razmik.
- Velike razlike v tlaku med priključkom za mrzlo in priključkom za toplo vodo je potrebno izravnati.



Električni priključek:

- Instalacijo in preizkuse mora izvesti pooblaščen elektro strokovnjak, pri čemer mora upoštevati VDE 0100 Del 701 in IEC 60364-7-701.
- Za električno priključitev je potrebna le ena vtičnica. Oskrba z električno energijo se izvaja preko zunanega transformatorja.
- V neposredni bližini se ne smejo nahajati lahko vnetljivi materiali.
- Temperatura okolice ne sme presegati 50 °C.
- Celotna oskrba z električno energijo se izvaja preko priključka za izmenični tok 230V/N/PE/50Hz.
- Zaščita se mora izvesti preko zaščitnega tokovnega stikala (RCD/ FI)
- z izračunanim diferenčnim tokom ≤ 30 mA.
- Če je potrebna izenačitev potenciala, jo izvedite lokalno.
- Pri električni instalaciji je treba upoštevati ustrezne VDE, nacionalne in EVU predpise v aktualno veljavni izdaji.
- Zagotovljeno mora biti, da se proizvod lahko odklopi od omrežja. Bodisi s pomočjo prosto dostopnega vtiča ali pa preko vsepolnega stikala po EN 60335-1, odst. 24.3.



Montaža: (glejte stran 303)

- Pozor! Armaturo je potrebno montirati, splakniti in testirati v skladu z veljavnimi predpisi. (Montaža po EN 1717)
Glejte Navodilo za montažo:
Raindance Rainfall 28411000
Raindance Rainmaker 28403000 / 28404000 / 28417000 / 28418000
- Vsa dela se smejo izvajati le pri odklopljeni napetosti.
- Osnovno telo 15941180 se lahko vgradi le navpično!
Montaža z nastavljivim obročem (A) je možna le v srednjem območju!
- Vse komponente morajo ostati dosegljive.

Tehnilised andmed:

Delovni tlak:	maks. 1 MPa
Priporočeni delovni tlak:	0,1 - 0,5 MPa
Preskusni tlak:	1,6 MPa
(1 MPa = 10 bar = 147 PSI)	
Temperatura tople vode:	maks. 80 °C
Priporočena temperatura tople vode:	65 °C
Razdalja od sredine:	G ¾
Priključki Dotok:	Mešana voda
Prost pretok pri 0,3 MPa:	
1 Porabnik:	35 l/min
2 Porabnik:	45 l/min



Pribor: (glejte stran 214)



Mere: (glejte stran 292)



Primeri montaže Raindance Rainfall: (glejte stran 295)



Primeri montaže Raindance Rainmaker: (glejte stran 299)



Upravljanje: (glejte stran 216)

- Pri izpadu 230 V omrežne napetosti priprave za prhanje ne more obratovati.
- Proizvod ni predviden za uporabo v povezavi s parno kopeljo!



Čiščenje Filtrirna mrežica: (glejte stran 309)





























Nadomestni deli (glejte stran 311)

Montaža glejte stran 303

Slovenski Tehnične informacije

Napaka	Vzrok	Pomoč
Brez vsake funkcije	<ul style="list-style-type: none"> - Ni oskrbe z napetostjo - Transformator osnovnega kompleta je pokvarjen - Sprejemnik je neugodno nameščen / okvarjen - Oddajnik ni nastavljen / je okvarjen 	<ul style="list-style-type: none"> - Zagotovite oskrbo z napetostjo - Zamenjajte transformator - Spremenite pozicijo sprejemnika oz. sprejemnik zamenjajte - Oddajnik nastavite / ga zamenjajte
Obratovalnega modusa ni moč konfigurirati	<ul style="list-style-type: none"> - Reed kontakt se ne nahaja na primerni poziciji za rozeto - Reed Kontakt je poškodovan 	<ul style="list-style-type: none"> - Reed kontakt namestite na rozeto - Zamenjajte priključni vodnik magnetnega ventila
Brez funkcije luči	<ul style="list-style-type: none"> - Transformator Rainmakerja ni vključen / je poškodovan - Vodniki svetlobnih relejev so poškodovani / okvarjeni 	<ul style="list-style-type: none"> - Zagotovite oskrbo z napetostjo transformatorja / transformator zamenjajte - Preverite povezave in svetlobne releje / jih zamenjajte
Porabniki se samodejno izklopijo	<ul style="list-style-type: none"> - Čas teka je shranjen v programskem modusu 	<ul style="list-style-type: none"> - V servisnem modusu čas podaljšanega teka zvišajte / izklopite
Armatura je netesna	<ul style="list-style-type: none"> - Magnetni ventil je umazan / okvarjen 	<ul style="list-style-type: none"> - Membrano magnetnega ventila očistite / zamenjajte
Pretok je prenizek	<ul style="list-style-type: none"> - Lovilnik umazanije na vhodni strani je umazan 	<ul style="list-style-type: none"> - Mustusesoel puhastada / vālja vahetada

Simboli

	Vodni priključek DN 20 Topla voda		Trafo		Potencialna izenačitev
	Vodni priključek DN 20 Mrzla voda		Sprejemnik		vse izklopljeno
	Odprite vodo		Kodirni vtič		Luč
	Zaprite vodo.		230V		Rain
	Od • je delovanje zagotovljeno.		12V		Whirl
	Odtočna kapacitetamora znašati več kot 50 l/min.		Prazna cev		Rainflow
	Odtok		Svetlobno upravljanje 27189000 (Ni vključeno!)		Rain AIR XXL
	Raindrain		Svetlobni rele Rainmaker		Rain AIR
	Sredina pršne kadi		Trafo Rainmaker		Silikon (brez očetne kisline)
			Lokalno predinstaliran priključek 12 V za luč (maks. 80 W)		

Montaža glejte stran 303

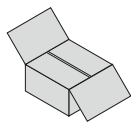

Slovenski Pribor

Trafo:

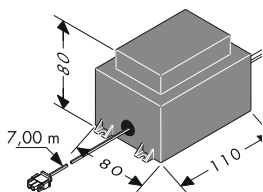

Zmogljivost zunanega transformatorja znaša 50 VA. Transformator se mora instalirati v suhem območju (zaščitna cona 3). Transformator se lahko skupaj s sprejemnikom vgradi v ohišje iz umetne mase, pri čemer je treba upoštevati EN/IEC 60335-1. (dimenzije ca. 250 x 160 x 92 mm, ni del dobavnega obsega.) Priložen kabel omogoča instalacijo transformatorja v oddaljenosti do 7,00 m od sprejemnika. V ta namen se mora predvideti prazno cev EN35 (ni del dobavnega obsega). Prazno cev je treba fiksirati najmanj vsakih 500 mm in upogibni polmer mora biti večji od 100 mm. Ca. 7,00 m dolg sekundarni vodnik transformatorja se ne sme skrajšati. Nepotrebno dolžino vodnika morate pospraviti v bližini varnostnega

transformatorja. Poškodovanega priključnega vodnika ne smete zamenjati. Transformator ne sme več obratovati.

Poškodovanega priključnega vodnika ne smete zamenjati. Če je omrežni priključni vodnik pokvarjen, mora elektro strokovnjak zamenjati vodnik vključno s transformatorjem.

Svetlobni rele:

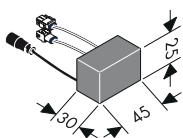

(le pri izvedbah z integrirano lučjo)

Svetlobni rele se sme obremeniti z maksimalno 12 V AC / 80 W.

Obratovanje na 230 V omrežju ni dopustno.

Svetlobno upravljanje:

27189000

(Ni vključeno)

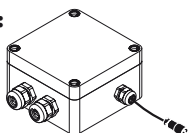

(iControl mobile 15944000)

Pri variantah z zunanjim izvirom svetlobe mora biti priključeno svetlobno krmilje. Slednje mora biti vedno dosegljivo.

Kodirni vtič:

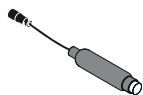

(Raindance Rainfall 28411000 / Raindance Rainmaker 28403000)

Kodirni vtič mora biti priključen pri različicah brez luči.

Če je pri različicah brez luči aktiviran servisni modus, svetilna dioda kodirnega vtiča kaže optična povratna sporočila.

Kodirno stikalo mora biti vedno dosegljivo.

Priključni vodnik Blok magnetnih ventilov / Priključni vodnik Luč:



7,50 m dolgega vodnika bloka magnetnih ventilov kot tudi 10,00 m dolgega vodnika za luč ne smete skrajšati. Nepotrebno dolžino vodnika morate pospraviti v bližini sprejemnika.

Vodnik bloka magnetnih ventilov in vodnik za luč je dovoljeno polagati le v priloženi prazni cevi (EN 20).

Prazno cev je treba fiksirati najmanj vsakih 500 mm in upogibni polmer mora biti večji od 100 mm.

Pozor: V prazne cevi za vodnik bloka magnetnih ventilov in vodnik za luč ni dovoljeno polaganje električnih vodnikov, ki prevajajo napetost nad 12V.

Montaža glejte stran 303

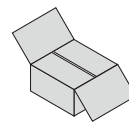

Sprejemnik:

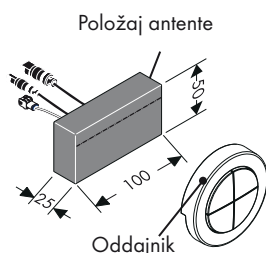

Sprejemnik mora biti po možnosti montiran v istem prostoru kot priprava za prhanje. V kolikor to ni možno, se lahko sprejemnik montira tudi v prostor, ki meji na pripravo za prhanje. Sprejemnika ni dovoljeno vgraditi v kovinsko ohišje, saj sicer ne more sprejemati signalov oddajnika. Poleg tega je treba zagotoviti, da se v bližini vgradnega mesta sprejemnika nahaja čim manj kovinskih delcev, ki delujejo kot izolacija pred signali.

Za optimalno prepoznavanje signalov mora biti antena sprejemnika po možnosti usmerjena proti oddajniku.

Oddajnik:



V dobavnem stanju je oddajnik že priučen na sprejemnik. Zaradi identičnih serijskih števil se oddajnik z lahkoto dodeli ustreznemu sprejemniku. Dodatne oz. naknadno kupljene oddajnike je treba priučiti Priučijo oz. shranijo se lahko maksimalno štirje oddajniki. (glejte stran 220/221 Modus za prijavo). Radijska frekvenca oddajnika je 868,3 MHz.

Opozorilo: Sprejemnik in oddajnik imata doseg ca. 10,00 m. Doseg je odvisen od tega, v kolikšni meri so radijski signali med oddajnikom in sprejemnikom oslabiljeni.

Opozorilo: Iz varnostnih razlogov uporabljajte oddajnik le v vidnem območju sistema za prhanje. V nasprotnem primeru se lahko nehote odpre voda.

Opozorilo: Pravilno postopanje pri zamenjavi pokvarjenega oddajnika z novim oddajnikom:

1. Izbris vseh oddajnikov. (Modus za prijavo ⇒ Izbrisni modus).
2. Ponovna priučitev vseh oddajnikov, razen pokvarjenega. (Servisni modus ⇒ Modus za prijavo).

Material	Oslabitev
Les, mavec, steklo (brez prevleke, brez kovine)	0 - 10 %
Opeka, iverne plošče	5 - 35 %
Beton z železnim armiranjem	10 - 90 %
Kovina, aluminijasto prekritje	90 - 100 %

Magnet:



Za aktiviranje servisnega modusa mora magnet aktivirati REED kontakt (za rozeto). (glejte stran 218/219 Servisni modus).

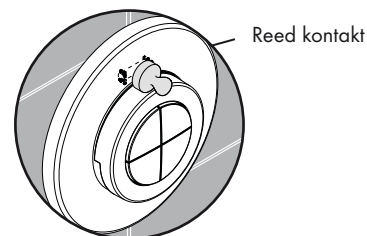

Raindance Rainfall

28411000

iControl mobile

15940180 / 15942000

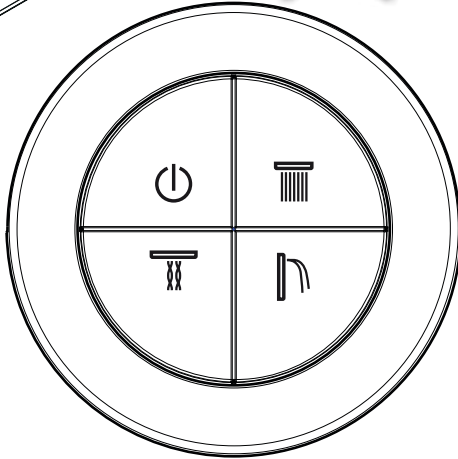
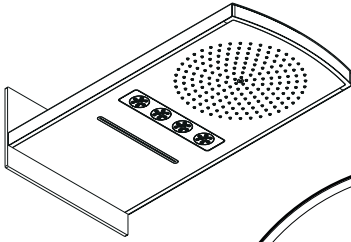

Raindance Rainfall

28411000

iControl mobile

15941180 / 15944000

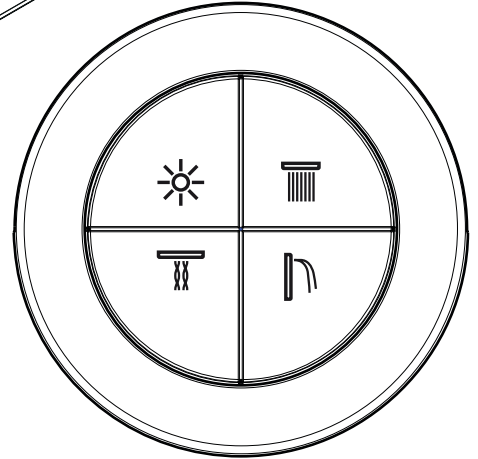
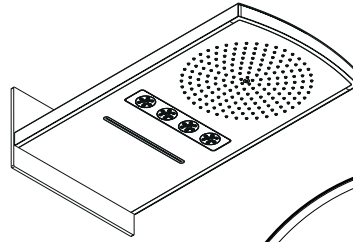

Raindance Rainmaker

28403000

iControl mobile

15940180 / 15943000

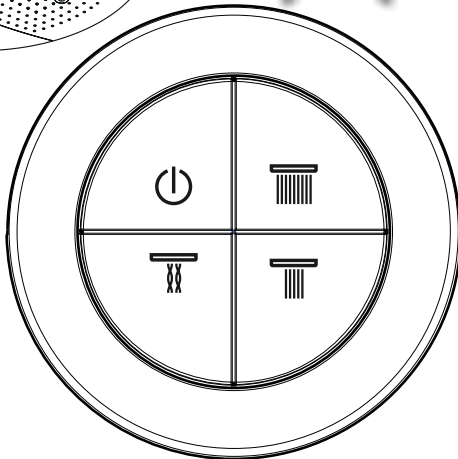
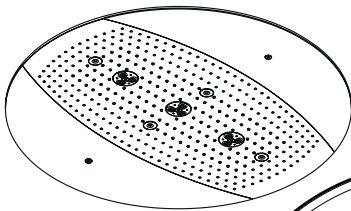

Raindance Rainmaker

28404000

iControl mobile

15941180 / 15945000

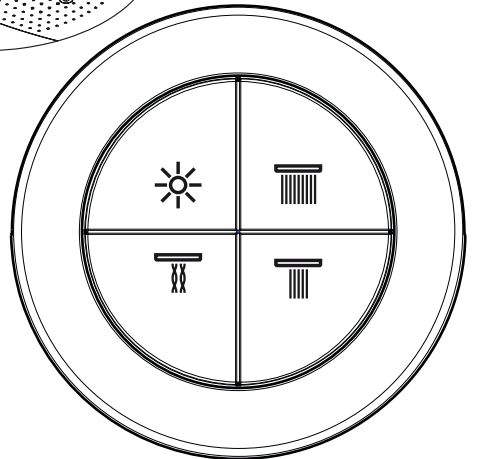
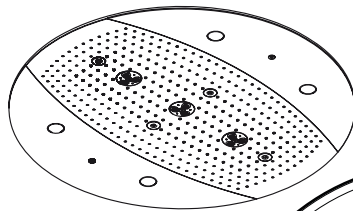

vse izklopljeno



Rain



Whirl



Rainflow



Luč



Rain AIR XXL



Rain AIR

Montaža glejte stran 303

Vklop in izklop prh in luči:

(Standardna funkcija z lučjo)

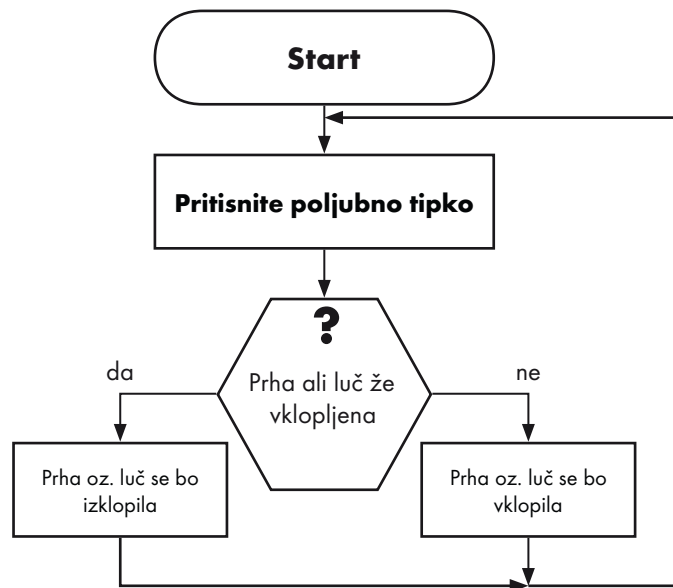

Vklop in izklop prh:

(Standardna funkcija brez luči)

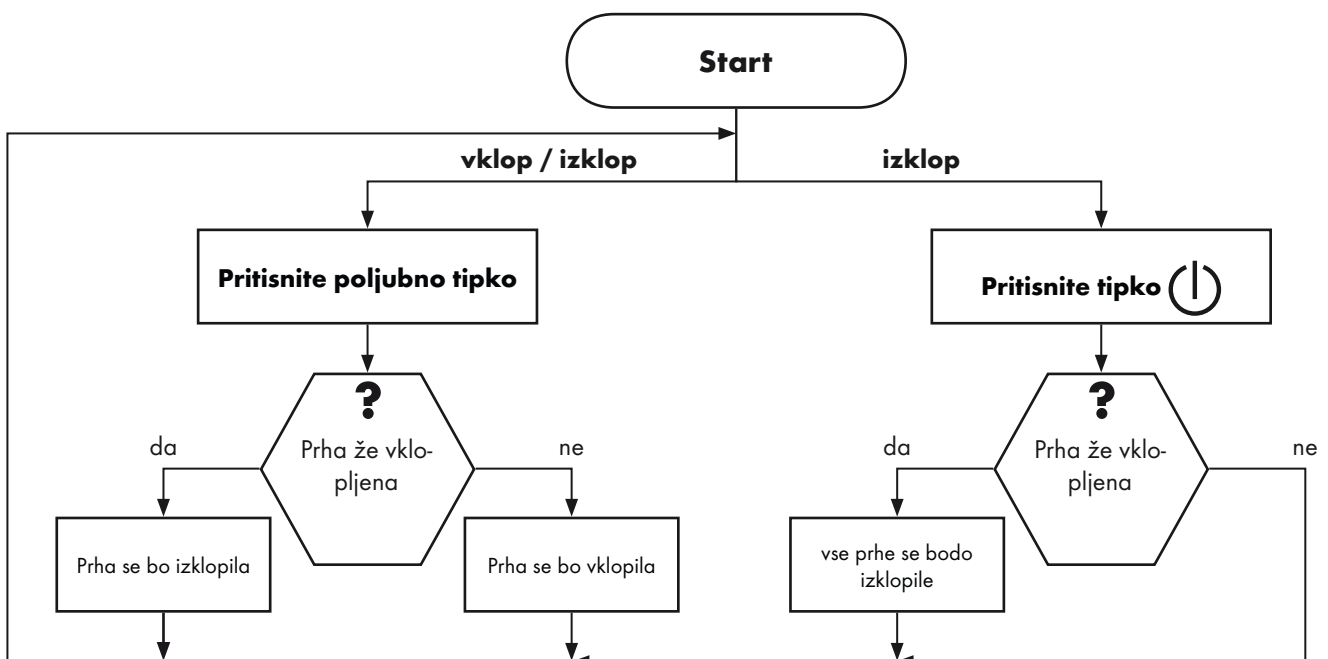

Montaža glejte stran 303

Slovenski Nivo za uporabnika

Raindance Rainfall
28411000

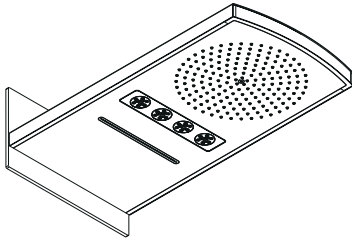

Obratovalni modus

Opozorilo:

Vse prhe morajo biti
izklopljene

Aktivirajte
REED-kontakt
z magnetom

Servisni modus

Opozorilo:

Luč / kodirni vtič
utripa 4x

Opozorilo:

Luč / Kodirni vtič se ugasne

Opozorilo:

Luč / kodirni vtič
utripa 2x

< 15 sek.

> 15 sek.

Dvojno kliknite tipko



Modus maksimalnega teka

Opozorilo:

Luč / kodirni vtič
utripa v 1sek. taktu

Dvojno kliknite
tipko

Modus prhanja

Opozorilo:

Luč / kodirni vtič
utripa v 2sek. taktu

< 15 sek.

> 15 sek.

< 15 sek.

> 15 sek.

Pritisnite
tipko



Pritisnite
tipko

Pritisnite
tipko

Pritisnite
tipko

Pritisnite
tipko

Pritisnite
tipko

**Obratovalni
časi:**
Prhanje: 30 s
Luč: 30 min

**Standard:
Obratovalni
časi:**
Prhanje: 60 s
Luč: 30 min

**Obratovalni
časi:**
Prhanje: 180 s
Luč: 30 min

**Obratovalni
časi:**
Prhanje + luč:
neomejeno

Standard
vklopita se lahko
maks. 2 prhi

Komfort 1:
vse prhe se
lahko vklopijo
hkrati

Slovenski Nivo za uporabnika

Raindance Rainmaker
28403000 / 28404000

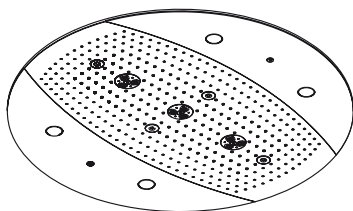

Obratovalni modus

Opozorilo:

Vse prhe morajo biti
izklopljene

**Aktivirajte
REED-kontakt
z magnetom**

Servisni modus

Opozorilo:

Luč / kodirni vtič
utripa 4x

Opozorilo:

Luč / Kodirni vtič se ugasne

Opozorilo:

Luč / kodirni vtič
utripa 2x

< 15 sek.

> 15 sek.

Dvojno kliknite tipko



Modus maksimalnega teka

Opozorilo:

Luč / kodirni vtič
utripa v 1sek. taktu

Modus prhanja

Opozorilo:

Luč / kodirni vtič
utripa v 2sek. taktu

< 15 sek.

> 15 sek.

< 15 sek.

> 15 sek.

**Pritisnite
tipko**



**Pritisnite
tipko**

**Pritisnite
tipko**

**Pritisnite
tipko**

**Obratovalni
časi:**
Prhanje: 30 s
Luč: 30 min

**Standard:
Obratovalni
časi:**
Prhanje: 60 s
Luč: 30 min

**Obratovalni
časi:**
Prhanje: 180 s
Luč: 30 min

**Obratovalni
časi:**
Prhanje + luč:
neomejeno

**Pritisnite
tipko**



**Pritisnite
tipko**

**Pritisnite
tipko**

Standard
vklopita se lahko
maks. 2 prhi

Komfort 1:
vse prhe se
lahko vklopijo
hkrati

Komfort 2:
Večja količina
vode, potrebna
le pri Rainmaker
funkciji
(deževanje)

Slovenski Nivo za strokovnjaka

Raindance Rainfall
28411000

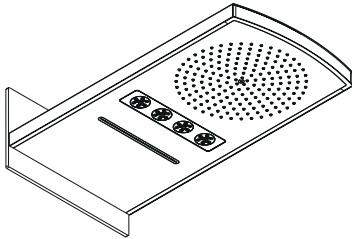

Obratovalni modus

Opozorilo:

Vse prhe morajo biti izklopljene



Aktivirajte REED-kontakt z magnetom

Servisni modus

Opozorilo:

Luč / kodirni vtič utripa 4x



Opozorilo:

Luč / kodirni vtič utripa 2x



Opozorilo:

Luč / Kodirni vtič se ugasne



< 15 sek.

> 15 sek.

Poljubno tipko 1 x pritisnite

Dvojno kliknite tipko

Dvojno kliknite tipko

Modus za prijavo

Izbrisni modus

Prezentacijski modus

?

Je oddajnik poznan?

da

ne

Opozorilo:

Luč / kodirni vtič utripa 1x
Število poznanih

?

oddajnikov ≤ 3 kosov

da

ne

Opozorilo:

najstarejši poznan oddajnik bo izbrisan

Opozorilo:

Luč / kodirni vtič utripa 3x

nov oddajnik bo priučen oz. shranjen

Opozorilo:

Luč / kodirni vtič utripa v 0,5sek. taktu



< 15 sek.

> 15 sek.

Pritisnite tipko ali

Pritisnite tipko

vsi oddajniki bodo izbrisani

uporabljen oddajnik bo izbrisan

Pritisnite tipko ali

Pritisnite tipko

Pritisnite tipko

Prezentacija 1 se bo pričela

Prezentacija 2 se bo pričela

Prezentacija 3 se bo pričela

Pritisnite poljubno tipko

Opozorilo:

vse prhe se izklopijo



Slovenski Nivo za strokovnjaka

Raindance Rainmaker
28403000 / 28404000

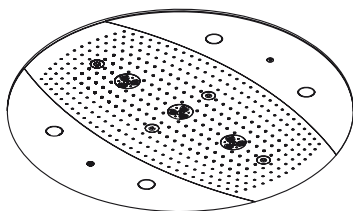

Obratovalni modus

Opozorilo:

Vse prhe morajo biti
izklopljene



**Aktivirajte
REED-kontakt
z magnetom**

Servisni modus

Opozorilo:

Luč / kodirni vtič
utripa 4x

Opozorilo:

Luč / kodirni vtič
utripa 2x

Opozorilo:

Luč / Kodirni vtič se ugasne

< 15 sek.

> 15 sek.

**Poljubno tipko 1 x
pritisnite**

**Dvojni kliknite
tipko**

**Dvojni kliknite
tipko**

Modus za prijavo

Izbrisni modus

Prezentacijski modus

?

da Je oddajnik
poznani? ne

Opozorilo:

Luč / kodirni vtič
utripa v 0,5sek. taktu

Opozorilo:

Luč / kodirni vtič
utripa v 4sek. taktu

Opozorilo:
Luč / kodirni vtič
utripa 1x
Število poznanih

?

da oddajnikov ≤ 3
kosov ne

< 15 sek.

> 15 sek.

< 15 sek.

> 15 sek.

**Pritisnite
tipko**
ali

**Pritisnite
tipko**

**Pritisnite
tipko**
ali

**Pritisnite
tipko**

**Pritisnite
tipko**

vsi oddajniki
bodo izbrisani

uporabljen
oddajnik bo
izbrisan

Prezentacija 1
se bo pričela

Prezentacija 2
se bo pričela

Prezentacija 3
se bo pričela

Opozorilo:
najstarejši
poznani
oddajnik bo
izbrisan

Opozorilo:

Luč / kodirni vtič
utripa 3x

nov oddajnik bo priučen oz.
shranjen

Pritisnite poljubno tipko

Opozorilo:

vse prhe se izklopijo

Normid ja direktiivid:

Toote kasutamine on tagatud järgmiste direktiividega:

- EN 15200
- EN 60335-2-105



Ohutusjuhised:

- Toodet tohib kasutada ainult pesemis-, hügieeni- ja kehapuhas-tamiseesmärkidel.
- Lapsed ei tohi dušisüsteemi järelevalveta kasutada.
- Lapsed, samuti kehaliste, vaimsete või tajupiirangutega täiskasvanud ei tohi dušisüsteemi järelevalveta kasutada. Alkoholi või narkootikumide mõju all olevad isikud ei tohi dušisüsteemi kasutada.
- Duši veejoad ei tohi kokku puutuda tundlike kehaosadega (nt silmad). Jätke duši ja keha vahele piisav vahe.
- Kui külma ja kuumu vee ühenduste surve on väga erinev, tuleb need tasakaalustada.



Elektriühendus:

- Paigaldustööd ja kontroll laske viia läbi sertifitseeritud spetsialistil vastavalt VDE 0100 osa 701 ja IEC 60364-7-701 eeskirjadele.
- Elektriühenduse loomiseks on vajalik pistikupesa. Elektriga varustamine toimub välise trafo kaudu.
- Vahetus läheduses ei tohi olla kergesti süttivaid materjale.
- Ümbritsev temperatuur ei tohi olla üle 50 °C.
- Kogu elektrivarustus toimub 230V/N/PE/50Hz vahelduvvooluühenduse kaudu.
- Kaitse peab toimuma rikkevoolu kaitseseadisega (RCD/FI) nominaal-jääkvooluga ≤ 30 mA.
- Juhul kui on vaja potsentsiaalühtlustust, tuleb see luua kohapeal.
- Elektriinstallatsiooni juures tuleb järgida vastavaid Saksa elektrotehnikute liidu VDE, riiklike ja energiafirma eeskirju nende kehtivas versioonis.
- Toote peab saama toitevõrgust lahutada. Selleks peab pistik olema vabalt juurdepääsetav või tuleb kasutada standardi EN 60335-1 p. 24.3 nõuetele vastavat lülitiit.



Paigaldamine: (vt lk 303)

- Tähelepanu! Seadmestiku paigaldamine, läbipesu ja kontrollimine peab toimuma vastavalt kehtivatele normidele. (Paigaldamine vastavalt standardile EN 1717) Vt paigaldamisjuhendit:
Raindance Rainfall 28411000
Raindance Rainmaker 28403000 / 28404000 / 28417000 / 28418000
- Kõik tööd tuleb teha pingevabas olekus.
- Põhikorpuse 15941180 võib paigaldada ainult vertikaalselt! Reguleerimisrõngaga (A) saab monteerida ainult eesmise ja keskmise alas!
- Juurdepääs peab olema tagatud kõikidele komponentidele.

Tehnični podatki:

Töörõhk:	maks. 1 MPa
Soovitav töörõhk:	0,1 - 0,5 MPa
Kontrollsurve::	1,6 MPa
(1 MPa = 10 baari = 147 PSI)	
Kuumu vee temperatuur::	maks. 80 °C
Soovitav kuumu vee temperatuur:	65 °C
distsants keskel:	G ¾
ühendused Sisend:	Sooja ja külma vee segu
Äravoolu surve 0,3 MPa	
1 Tarbija:	35 l/min
2 Tarbija:	45 l/min



Lisavarustus: (vt lk 224)



Mõõtude: (vt lk 292)



Paigalduse näited Raindance Rainfall: (vt lk 295)



Paigalduse näited Raindance Rainmaker: (vt lk 299)



Kasutamine: (vt lk 226)

- 230 V võrgupinge puudumisel ei saa dušisüsteemi kasutusele võtta.
- Toode ei sobi kasutamiseks aurusaunas!





























Puhastamine filter: (vt lk 309)

Varuosad (vt lk 311)

Estonia Tehniline teave

Rike	Põhjus	Lahendus
Funktsioon puudub	- Toitepinge puudub - Põhikomplekti trafo rikkis - Vastuvõtja asukoht vale / vastuvõtja rikkis - Saatja pole registreeritud / saatja rikkis	- Tagage toitepinge olemasolu - Vahetage trafo - Muutke vastuvõtja asukohta või vahetage vastuvõtja välja - Registreerige saatja / vahetage välja
Töörežiimi ei saa seadistada	- Magnetkontakti asukoht ilukatte taga vale - Magnetkontakt rikkis	- Paigaldage magnetkontakt ilukattele - Vahetage magnetventiili ühenduskaabel välja
Valgusti ei tööta	- Rainmakeri trafo pole paigaldatud / rikkis - Valgusti releede toitekaablid katki	- Tagage trafo toitepingega varustamine / vahetage trafo välja - Kontrollige ühendusi ja valgustite releesid / vahetage välja
Tarbijad lülituvad iseenesest välja	- Tööaeg on määratud programmirežiimis	- Pikendage teenindusrežiimis järeltöö aega / lülitage välja
Segisti lekib	- Magnetventiil must/rikkis	- Puhastage magnetventiili membraane / vahetage välja
Liiga väike läbivool	- Sisendpoole mustusekoguja määrduanud	- Lovilnik umazaniye očistite oz. zamenajajte

Sümbolid

	Veeühendus DN 20 Soe vesi		transformaator		Potentsiaali tasakaalustamine
	Veeühendus DN 20 Külम vesi		Vastuvõtja		kõik väljas
	Keerake vesi lahti		Kodeerimispistik		Valgus
	Keerake vesi kinni	— —	230V		Rain
	Alates • on funktsioneerimine garanteeritud	— — — —	12V		Whirl
	Äravoolu jõudlus peab olema suurem kui 50 l/min.		Paigaldustoru		Rainflow
	Äravool		Valguse juhtimine 27189000 (ei sisaldu komplektis)		Rain AIR XXL
	Raindrain		Valgusrelee Rainmaker		Rain AIR
	Dušivanni kese		transformaator Rainmaker		Silikoon (äädikhappeta!)
			Kohapeal paigaldatud 12 V ühendus valgustuse jaoks (maks 80 W)		

Paigaldamine vt lk 303

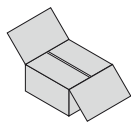

Estonia Lisavarustus

transformaator:

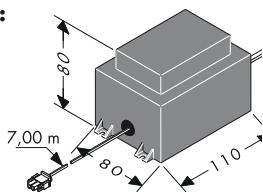

Välise trafo võimsus on 50 VA. Trafo tuleb paigaldada kuiva alasse (kaitsetsoon 3). Trafo võib koos vastuvõtjaga vastavalt EN/IEC 60335-1 paigaldada kunstmaterjalist korpusesse. (mõõtmed ca 250 x 160 x 92 mm, ei kuulu tarnemahtu.) Kaasa pandud kaabel võimaldab trafo paigaldada vastuvõtjast kuni 7,00 m kaugusele. Kasutage selleks torurüüži EN35 (ei kuulu tarnemahtu). Torurüüž tuleb fikseerida iga 500 mm järel ja painderaadius peab olema suurem kui 100 mm. Ca 7,00 m trafo lisajuhtet ei tohi lühendada. Mittevajalik juhtme pikkus tuleks paigutada kaitsetransformaatori lähedusse. Kahjustatud ühendusjuhet ei tohi asendada. Siis trafot enam kasutada ei tohi.

Kahjustatud ühendusjuhet ei tohi asendada. Kui toitekaabel on rikkis, peab elektrik kaabli koos trafoga välja vahetama.

Valgusrelee:

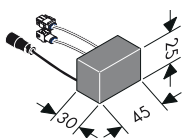

(ainult integreeritud valgustiga mudelite puhul)
Valgusrelee koormus tohib olla maksimaalselt 12 V vahelduvvoolu / 80 W.
Töötamine 230 V võrgus ei ole lubatud.

Valguse juhtimine: 27189000

(ei sisaldu komplektis)

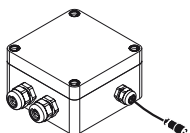

(iControl mobile 15944000)
Välise valgustiga variantide puhul tuleb ühendada valguse juhtsüsteem.
Ligipääs valguse juhtsüsteemile peab olema alati tagatud.

Kodeerimispistik:

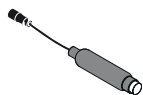

(Raindance Rainfall 28411000 / Raindance Rainmaker 28403000)
Kodeerimispistik ühendatakse valgustusea versioonidele.
Kui teenindusrežiim on valgustusea versioonide puhul aktiveeritud, annab kodeerimispistiku valgusdiood optilist tagasisidet.
Juurdepääs kodeerimispistikule peab olema alati tagatud.

Ühendusjuhe Magnetventiili plokk / Ühendusjuhe Valgus:



7,50 m pikka magnetventiili ploki juhe, samuti 10,00 m pikka valgusjuhet lühendada ei tohi. Mittevajalik juhtme pikkus tuleks paigutada vastuvõtja lähedusse.
Magnetventiili ploki juhtme ja valgusjuhtme võib paigaldada ainult kaasa pandud torurüüži (EN 20).
Torurüüž tuleb fikseerida iga 500 mm järel ja painderaadius peab olema suurem kui 100 mm.

Tähelepanu: Magnetventiili ploki juhtme ja valgusjuhtme torurüüži ei tohi paigaldada elektrijuhtmeid, mille pinget on suurem kui 12V.

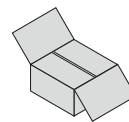

Vastuvõtja:

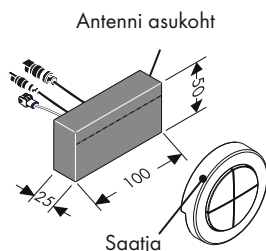

Vastuvõtja peaks olema eelistatult paigaldatud dušisüsteemiga samasse ruumi. Kui see ei ole võimalik, siis võib saatja paigaldada ka dušisüsteemi kõrval paiknevasse ruumi. Vastuvõtjat ei tohi paigaldada metallkorpusesse, kuna see segab saatja signaali. Peale selle tuleb pöörata tähelepanu sellele, et vastuvõtja paigalduskoha läheduses oleks võimalikult vähe segavaid metallist detaile. Signaali paremaks püüdmiseks peaks vastuvõtja antenn olema suunatud saatjale.

Saatja:



Tarnimisel on saatja juba vastuvõtjale programmeeritud. Identsed seerianumbrid võimaldavad saatja ja vastuvõtja ühendamist. Tagantjärele lisanduv täiendav saatja tuleb vastavalt programmeerida. Programmeerida või salvestada saab maksimaalselt 4 saatjat. (vt lk 230/231 Registreerimisrežiim). Saatja sagedus on 868,3 MHz.

Märkus: Vastuvõtja ja saatja ulatus on ca 10,00 m. Ulatus sõltub sellest, kui tugevasti saatja ja vastuvõtja vahel signaali summutatakse.

Märkus: Ohutuspõhjustel tohib saatjat ainult dušisüsteemi vaateväljas kasutada. Vastasel korral võib tagajärjeks olla vee juhuslik sisselülitamine.

Märkus: Korrektne toimimisviis vigase saatja väljavahetamisel uue saatja vastu

1. Kõikide saatjate kustutamine (Registreerimisrežiim ⇒ Kustutamistrežiim).
2. Kõik saatjad, välja arvatud defektne, programmeeritakse uuesti. (Varuosežiim ⇒ Registreerimisrežiim).

Materjal	Isolatsioon
Puit, kips, klaas (katmata, metallivaba)	0 - 10 %
Tellis, pressitud puitlaastplaadid	5 - 35 %
Raudarmatuuriga betoon	10 - 90 %
Metall, kaetud alumiinium	90 - 100 %

Magnet:



Hooldusrežiimi aktiveerimiseks tuleb peab magnet vajutama REED-kontaktile (roseti taga). (vt lk 228/229 Varuosežiim).

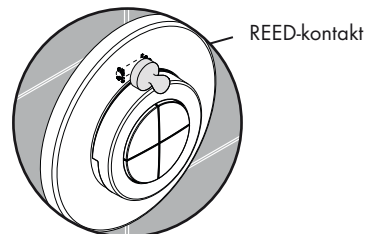

Raindance Rainfall

28411000

iControl mobile

15940180 / 15942000

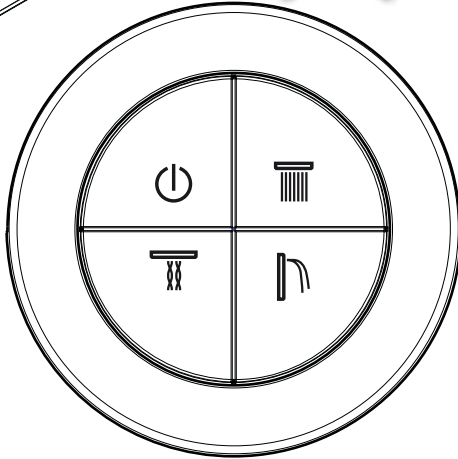
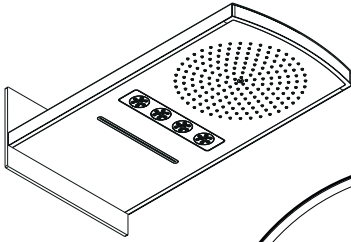

Raindance Rainfall

28411000

iControl mobile

15941180 / 15944000

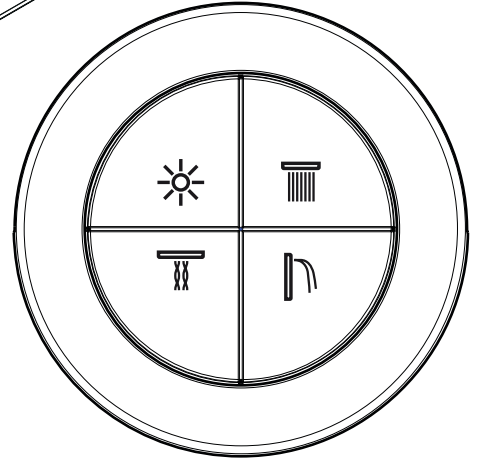
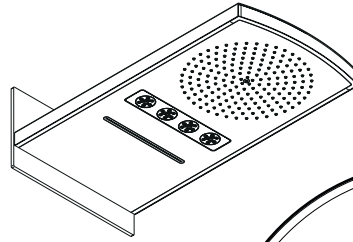

Raindance Rainmaker

28403000

iControl mobile

15940180 / 15943000

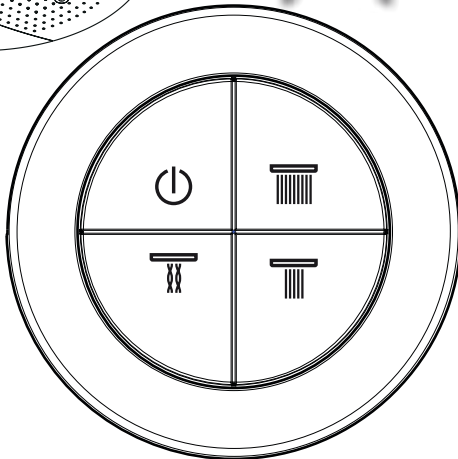
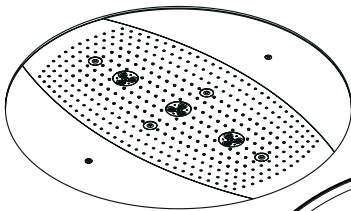

Raindance Rainmaker

28404000

iControl mobile

15941180 / 15945000

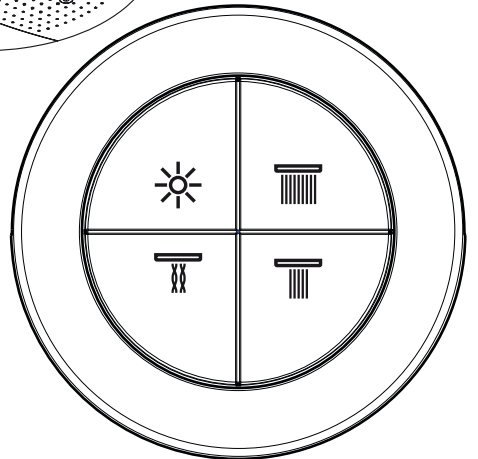
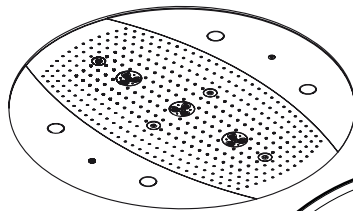

kõik väljas



Rain



Whirl



Rainflow



Valgus



Rain AIR XXL



Rain AIR

Duši ja valguse sisse- ja väljalülitamine:

(Standardfunktsioon koos valgusega)

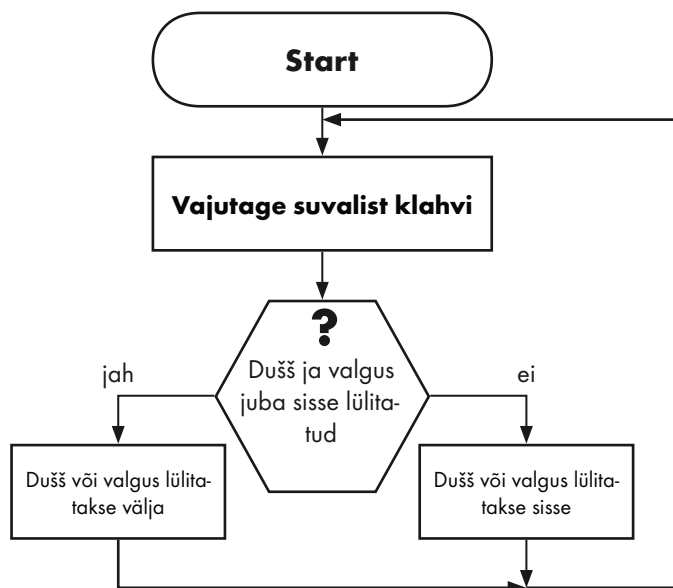

Vajutage suvalist klahvi:

(Standardfunktsioon ilma valguseta)

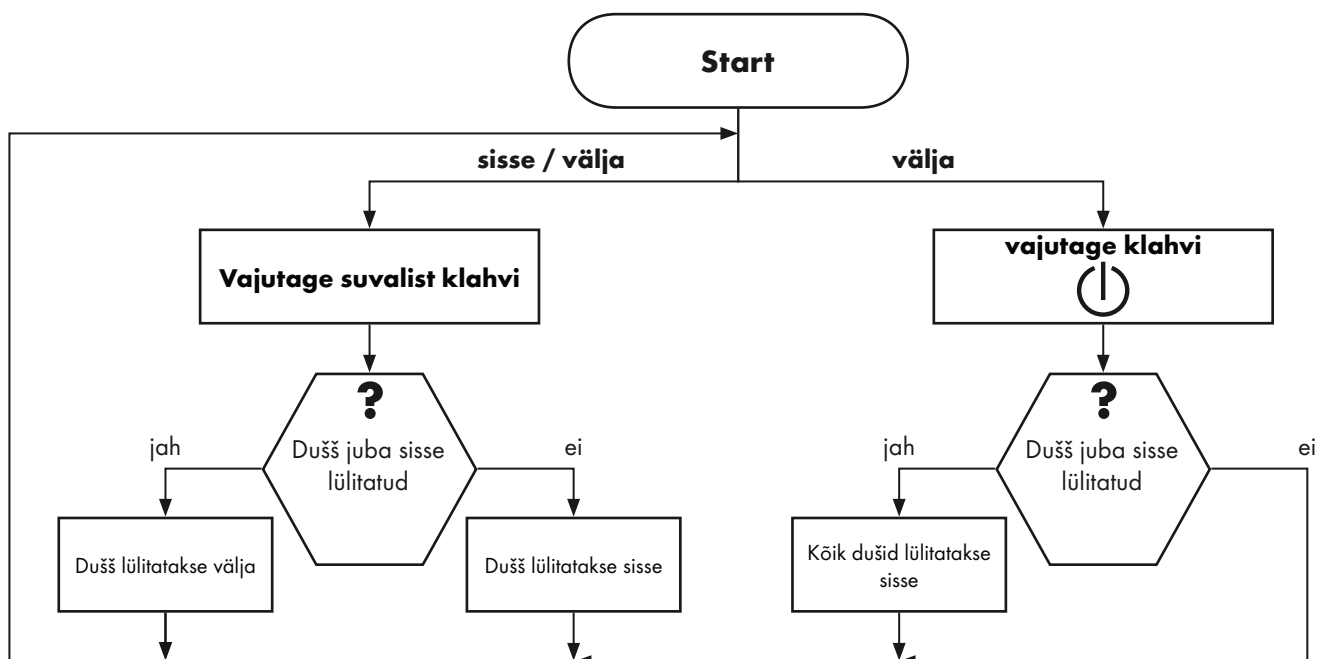

Estonia Kasutaja tasand

Raindance Rainmaker
28403000 / 28404000

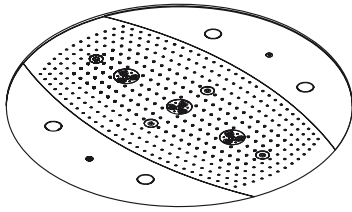

Töörežiim

Märkus:
Kõik dušid peavad olema
välja lülitatud



Varuosežiim

Märkus:
Valgus / kodeerimispiistik
vilgub 4 x

Märkus:
Valgus / kodeerimispiistik
vilgub 2 x

Märkus:
Valgus / kodeerimispiistik
lülitub välja

< 15 sek.

> 15 sek.

**Klõikige kaks korda
klahvil** või

Topeltklõik klahvil

**Maksimaalse tööaja
režiim**

Duširežiim

Märkus:
Valgus / kodeerimispiistik
vilgub 1 sek taktiga

Märkus:
Valgus / kodeerimispiistik
vilgub 2 sek taktiga

< 15 sek.

> 15 sek.

< 15 sek.

> 15 sek.

**vajutage
klahvi** või
**vajutage
klahvi**
**vajutage
klahvi**
**vajutage
klahvi**

**vajutage
klahvi** või
**vajutage
klahvi**
**vajutage
klahvi**

Tööajad:
Dušid: 30 s
Valgus: 30 min

Standard:
Tööajad:
Dušid: 60 s
Valgus: 30 min

Tööajad:
Dušid: 180 s
Valgus: 30 min

Tööajad:
Dušid + valgus
piiranguta

Standard
sisse lülitatud
võib olla maks.
2 dušši

Mugavus 1:
kõik dušid
võivad olla
samaaegselt
sisse lülitatud

Mugavus 2:
Suurem veehulk,
vajalik ainult
Rainmakeri
puhul

**Estonia
Spetsialisti tasand**

Raindance Rainfall
28411000

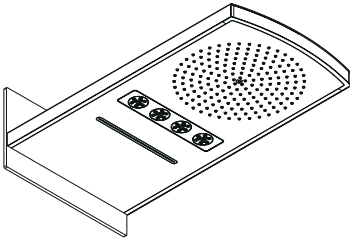

Töörežiim

Märkus:
Kõik dušid peavad olema
välja lülitatud



Varuosežiim
Märkus:
Valgus / kodeerimispistik
vilgub 4 x

Märkus:
Valgus / kodeerimispistik
vilgub 2 x

Märkus:
Valgus / kodeerimispistik
lülitub välja

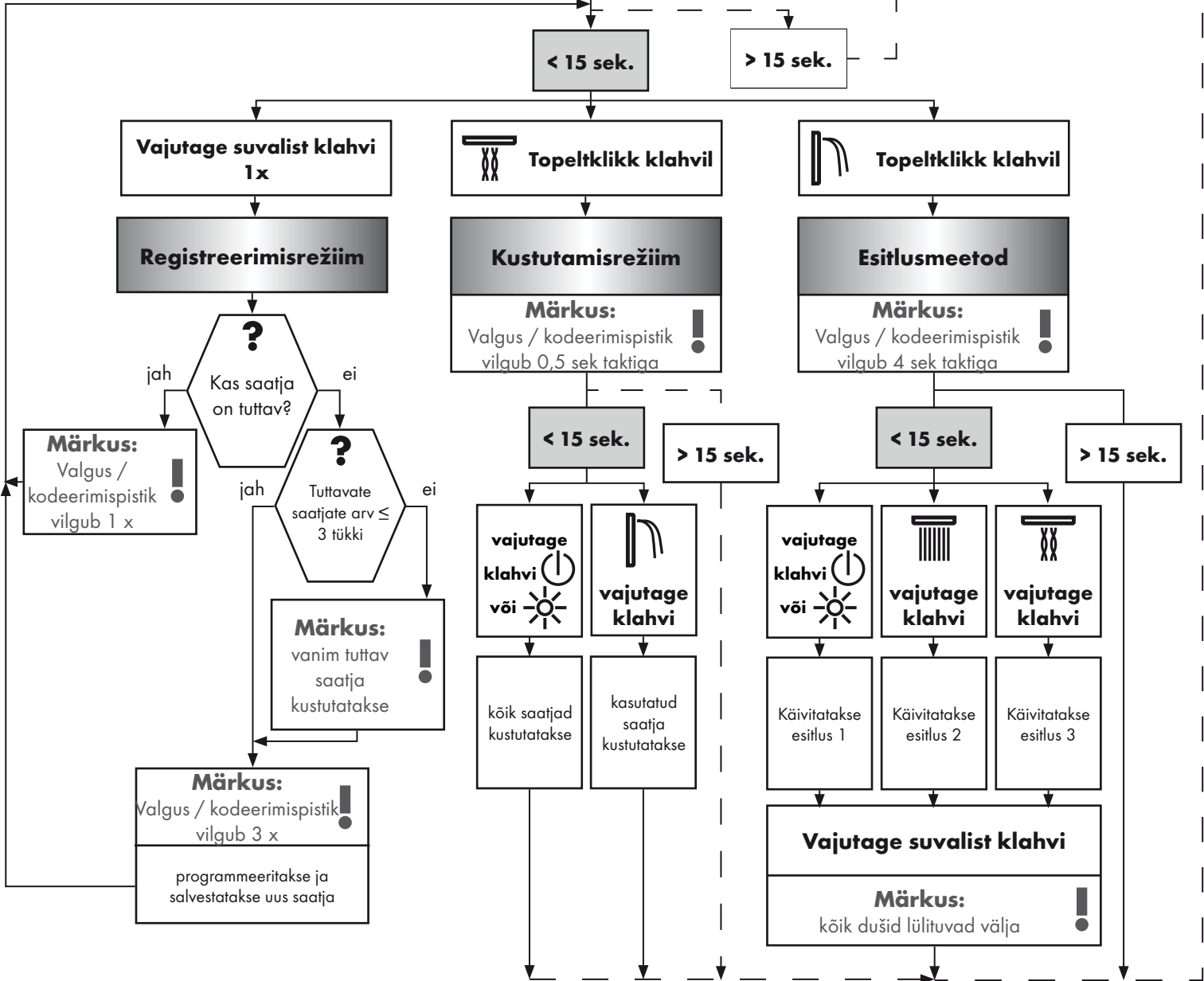

Estonia Spetsialisti tasand

Raindance Rainmaker
28403000 / 28404000

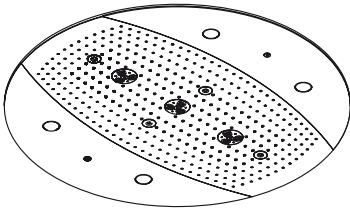

Töörežiim

Märkus:
Kõik dušid peavad olema
välja lülitatud



Varuõõõim

Märkus:
Valgus / kodeerimispiistik
vilgub 4 x

Märkus:
Valgus / kodeerimispiistik
vilgub 2 x

Märkus:
Valgus / kodeerimispiistik
lülitub välja

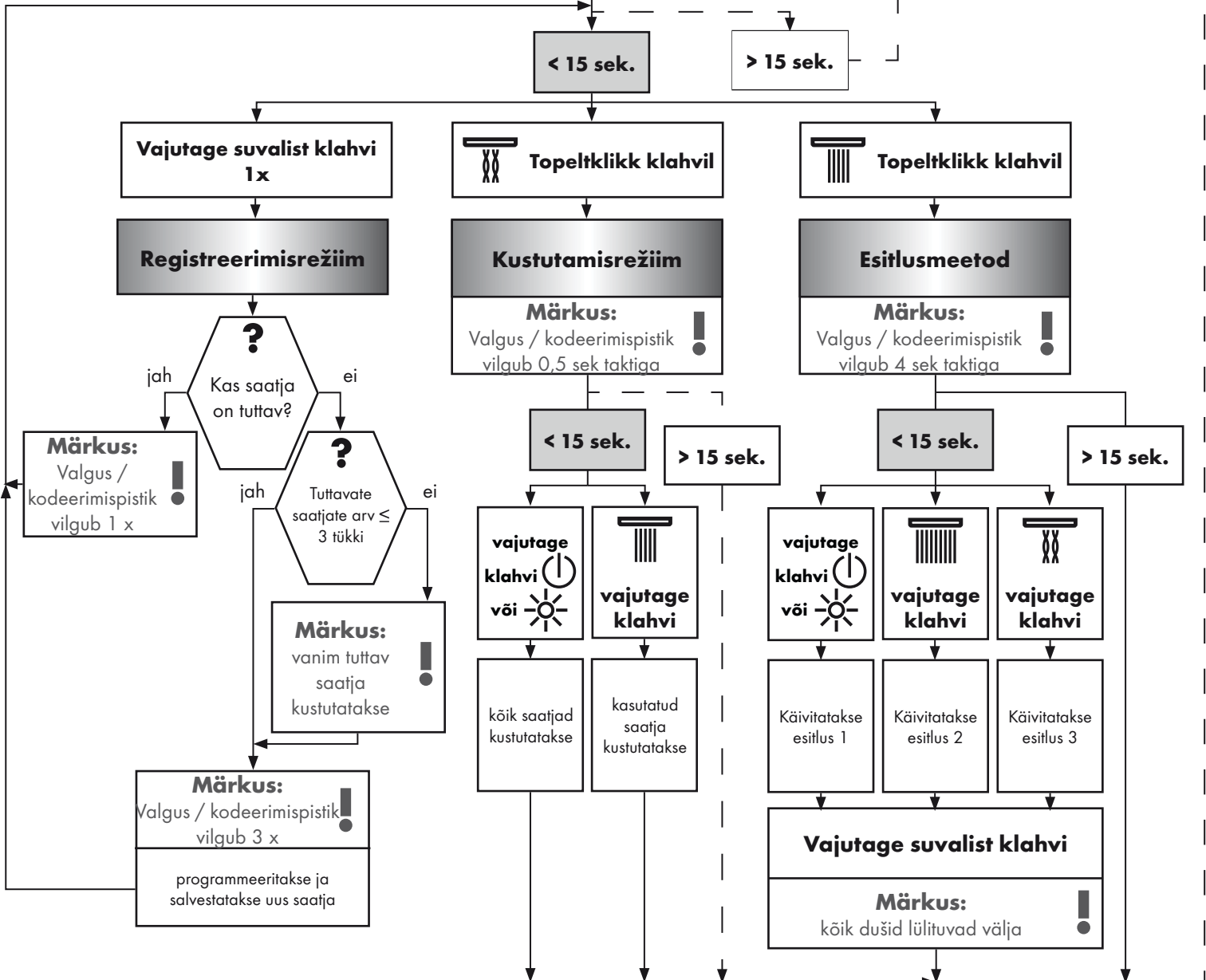

Standarti un direktīvas:

Produkta lietošanu regulē šādas direktīvas:

- EN 15200
- EN 60335-2-105



Drošības norādes:

- Šo produktu drīkst izmantot tikai, lai mazgātos, higiēnai un ķermeņa tīrīšanai.
- Bērni bez uzraudzības nedrīkst izmantot šo dušas sistēmu.
- Bērni, kā arī pieaugušie ar fiziskiem, garīgiem un / vai sensoriskiem ierobežojumiem nedrīkst lietot šo dušas sistēmu bez uzraudzības. Personas, kas atrodas alkohola vai narkotisko vielu iespaidā, nedrīkst lietot šo dušas sistēmu.
- Nepieciešams izvairīties no dušas strūkļas tieša kontakta ar jutīgām ķermeņa daļām (piem., acīm). Nepieciešams ievērot pietiekošu attālumu starp dušu un ķermeni.
- Jāizlīdzina spiediena atšķirības starp aukstā un karstā ūdens pievadēm.



Elektroapgādes pieslēgvietas:

- Instalācijas un pārbaudes darbus jāveic sertificētam speciālistam saskaņā ar DIN VDE 0100 701. d. un IEC 60364-7-701.
- Elektriskajam pieslēgumam ir nepieciešama tikai viena kontaktligzda. Elektroenerģijas padeve notiek caur ārējo transformatoru.
- Tiešā tuvumā nedrīkst atrasties viegli uzliesmojoši materiāli.
- Apkārtējās vides temperatūra nedrīkst pārsniegt 50°C.
- Visa elektroenerģijas padeve notiek ar 230V/N/PE/50Hz pieslēgumu maiņstrāvai.
- Jānodrošina noplūdes strāvas aizsargsistēma (RCD/ FI) ar izmērīto strāvas starpību ≤ 30 mA.
- Ja nepieciešama potenciāla izlīdzināšana, tā jānodrošina pašam pasūtītājam.
- Izveidojot elektroinstalāciju, jāņem vērā attiecīgie VDE (Vācijas elektrotehnikas savienības), valsts un energoapgādes uzņēmumu noteikumi attiecīgi spēkā esošajā redakcijā.
- Jānodrošina, ka produktu ir iespējams atvienot no tīkla: vai nu ar brīvi pieejamu kontaktdakšu, vai ar visu polu slēdzi atbilstoši EN 60335-1 24.3. punktam.



Montāža: (skat. lpp. 303)

- Uzmanību! Jaucējkrāns jāmontē, jāskalo un jāpārbauda atbilstoši spēkā esošajām normām. (Instalācija saskaņā ar EN 1717) Skatīt montāžas instrukciju Raindance Rainfall 28411000 Raindance Rainmaker 28403000 / 28404000 / 28417000 / 28418000
- Visus darbus drīkst veikt tikai tad, kad ir atvienots spriegums.
- Pamatni 15941180 iespējams montēt tikai vertikāli! Montāža ar regulēšanas gredzenu (A) iespējama vienīgi priekšējā un vidējā zonā!
- Visiem komponentiem jābūt pieejamiem.

Tehniskie dati:

Darba spiediens::	maks. 1 MPa
Ieteicamais darba spiediens:	0,1 - 0,5 MPa
Pārbaudes spiediens::	1,6 MPa
(1 MPa = 10 bar = 147 PSI)	
Karstā ūdens temperatūra::	maks. 80° C
Ieteicamā karstā ūdens temperatūra:	65° C
Pieslēguma izmēri:	G 3/4
Pieslēgumi leēja:	Sajauktais ūdens
Brīva caurplūde, ja ir 0,3 MPa:	
1 Patērētājs:	35 l/min
2 Patērētājs:	45 l/min



Aksesuāri: (skat. lpp. 234)



Izmērus: (skat. lpp. 292)



Montāžas piemēri Raindance Rainfall: (skat. lpp. 295)



Montāžas piemēri Raindance Rainmaker: (skat. lpp. 299)



Lietošana: (skat. lpp. 236)

- 230 V elektroīkla sprieguma pārrāvuma gadījumā nav iespējama dušas iekārtas ekspluatācija.
- Produkts nav paredzēts lietošanai kopā ar tvaika vannu!































Tīrīšana Filtrs: (skat. lpp. 309)

Rezerves daļas (skat. lpp. 311)

Latviski Tehniskā informācija

Traucējums	Iemesls	Bojājumu novēršana
Nekas nedarbojas	<ul style="list-style-type: none"> - Nav sprieguma - Bojāts pamatkomplekta transformators - Uztvērējs novietots nepareizi/bojāts - Raidītājs novietots nepareizi/bojāts 	<ul style="list-style-type: none"> - Nodrošināt strāvas padevi - Nomainīt transformatoru - Izmainīt uztvērēja pozīciju vai nomainīt uztvērēju - Ieprogrammēt/nomainīt raidītāju
Darbības režīmu nav iespējams konfigurēt	<ul style="list-style-type: none"> - Magnēt vadāmais kontakts neatrodas piemērotā pozīcijā aiz rozetes - Magnēt vadāmais kontakts bojāts 	<ul style="list-style-type: none"> - Magnēt vadāmo kontaktu novietot pie rozetes - Nomainīt magnētiskā vārsta pievadu
Nav gaismas	<ul style="list-style-type: none"> - „Rainmaker” transformatoram nav kontakta/tas ir bojāts - Gaismas releju pievadi bojāti 	<ul style="list-style-type: none"> - Nodrošināt strāvas pievadi transformatoram/nomainīt transformatoru - Pārbaudīt/nomainīt savienojumus un gaismas relejus
Lietotāji paši izslēdzas	<ul style="list-style-type: none"> - Darbības laiks saglabāts programmēšanas režīmā 	<ul style="list-style-type: none"> - Apkopes režīmā pagarināt/izslēgt inerces darbības laiku
Armatūrā ir sūce	<ul style="list-style-type: none"> - Magnētiskais vārsts aizsērējis/bojāts 	<ul style="list-style-type: none"> - Notīrīt/nomainīt magnētiskā vārsta membrānas
Pārāk maza caurplūde	<ul style="list-style-type: none"> - Netīrumu filtrs ieejas pusē aizsērējis 	<ul style="list-style-type: none"> - Iztīrīt / nomainīt filtru

Simboli

	Ūdensvada pieslēgvietā DN 20 Siltais ūdens		Transformators		Potenciāla izlīdzināšana
	Ūdensvada pieslēgvietā DN 20 Aukstais ūdens		Uztvērējs		viss izslēgts
	Atgrieziet ūdeni		Kodēšanas spraudnis		Gaismā
	Noslēgt ūdeni		230V		Rain
	No • funkcija nodrošināta		12V		Whirl
	Noteces veikspējai jābūt vairāk nekā 50 l/min.		Tukša caurule		Rainflow
	Notece		Gaismas vadība 27189000 (neietilpst komplektā!)		Rain AIR XXL
	Raindrain		Gaismas relejs Rainmaker		Rain AIR
	Dušas paliktna vidus		Transformators Rainmaker		Silikons (etiķskābi nesaturošs!)
			Telpā iepriekš instalēts 12 V kontakts gaismai (maks. 80 W)		

Montāža skat. lpp. 303

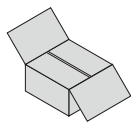

Latviski Aksešuāri

Transformators:

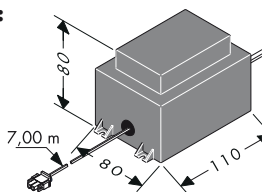

Ārējā transformatora jauda ir 50 VA. Transformators jāinstalē sausā vietā (3. aizsardzības zona). Transformatoru kopā ar uztvērēju var montēt plastmasas korpusā, saskaņā ar EN/IEC 60335-1. ((izmērs apm. 250x160x92 mm)., nav iekļauts piegādes komplektā.) Komplektācijā iekļautais kabelis ļauj instalēt transformatoru līdz pat 7,00 m no uztvērēja. Tas jāveic ar kabelkanāla EN35 palīdzību (nav iekļauts piegādes komplektā). Kabelkanāls jānofiksē vismazpēc katriem 500 mm un locīšanas rādiusam jābūt lielākam par 100 mm.

Nekrīkst saīsināt apm. 7,00 m garo transformatora sekundāro ķēdes vadu. Neizmantojamo vada garumu ieteicams novietot drošības transformatora

tuvumā. Aizliegts mainīt bojātā pieslēguma vadu. Tādā gadījumā aizliegts ekspluatēt transformatoru.

Aizliegts mainīt bojātā pieslēguma vadu. Ja ir bojāts tīkla pieslēguma vads, sertificētam elektriķim tas ir jānomaina, ieskaitot strāvas pārveidotāju.

Gaismas relejs:

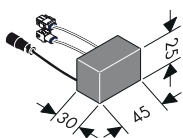

(tikai variantiem ar iebūvētu apgaismojumu)
Gaismas releju maksimāli drīkst noslogot ar 12 V maiņstrāvu/80 W.
Ekspluatācija ar 230 V tīklu nav pieļaujama.

Gaismas vadība:

27189000

(komplektā netiek piegādāts)

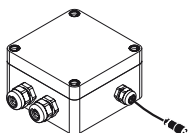

(iControl mobile 15944000)
Gaismu vadības sistēma jāpieslēdz modeļiem ar ārēju gaismas avotu. Gaismu vadības sistēmai vienmēr jābūt brīvi pieejamai.

Kodēšanas spraudnis:

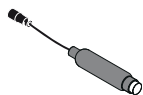

(Raindance Rainfall 28411000 / Raindance Rainmaker 28403000)
Kodēšanas spraudnis jāpieslēdz variantos bez gaismas.
Kad variantiem bez gaismas ir aktivizēts servisa režīms, kodēšanas spraudņa gaismas diode uzrāda optiskos atbildes signālus.
Kodēšanas spraudņiem vienmēr jābūt pieejamam.

Pieslēguma vads Magnēta ventiļa bloks / Pieslēguma vads Gaisma:



7,50 m garais magnēta ventiļa bloka vads, kā arī 10,00 m garais gaismas vads nedrīkst tikt saīsināts. Neizmanojamo vada garumu, ieteicams uzglabāt uztvērēja tuvumā.

Magnēta ventiļa bloka vadu un gaismas vadu drīkst novietot tikai nodrošinātajā kabelkanālā (EN 20).

Kabelkanāls jānofiksē vismazpēc katriem 500 mm un locīšanas rādiusam jābūt lielākam par 100 mm.

Uzmanību: Magnēta ventiļa bloka vadam un gaismas vadam paredzētajā kabelkanālā nedrīkst ievietot elektriskos vadus, kuru spriegums pārsniedz 12V.

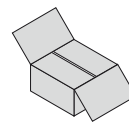

Uztvērējs:

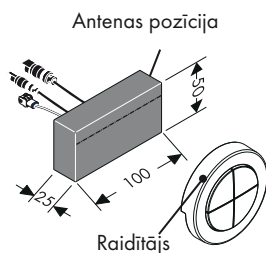

Uztvērēju ieteicams montēt vienā telpā ar dušas iekārtu.

Ja tomēr tas nav iespējams, uztvērēju drīkst montēt arī blakus telpā.

Uztvērēju nedrīkst montēt metāla korpusā, jo tādējādi var tikt bloķēti raidītāja signāli. Vēl ieteicams ievērot, lai vietā, kur iemontēts uztvērējs, būtu pēc iespējas mazāk metāla daļu, kas bloķē signālu.

Optimālai signālu uztveršanai uztvērēja antenai jābūt pagrieztai raidītāja virzienā.

Raidītājs:



Piegādātais raidītājs jau ir noregulēts uz uztvērēju. Raidītājs var tikt sasaistīts ar uztvērēju, kuram ir identisks sērijas numurs.

Papildu, resp., vēlāk iegādāti raidītāji ir jāregulē. Ir iespējams regulēt, resp., saglabāt maksimāli 4 raidītājus. (skat. lpp. 240/241 Pieteikšanās režīms).

Raidītāja pārraidīšanas frekvence ir 868,3 MHz.

Norāde: Atbilstoša procedūra, nomainot bojāto raidītāju pret jaunu:

1. Izdzēst visus raidītājus. (Pieteikšanās režīms ⇒ Dzēšanas režīms).
2. Regulēt visus raidītājus, izņemot bojāto. (Apkopes režīms ⇒ Pieteikšanās režīms).

Norāde: Uztvērēja un raidītāja darbības rādiuss ir apm. 10,00 m. Darbības rādiuss ir atkarīgs no tā, kā tiek slāpēti signāli starp raidītāju un uztvērēju.

Norāde: Drošības apsvērumu dēļ raidītāju lietojiet tikai no tādas vietas, no kuras jūs redzat dušas sistēmu. Citādi nejauši varat ieslēgt ūdens padevi.

Materiāls	Klusināšana
Koksne, ģipsis, stikls (bez pārklājuma, bez metāla)	0 - 10 %
Ķieģeļi, biezs kartons	5 - 35 %
Betons ar dzelzs armatūru	10 - 90 %
Metāls, alumīnija pārklājums	90 - 100 %

Magnēts:



Lai aktivizētu apkopes režīmu, magnētam nepieciešams aktivizēt magnēt vadāmo kontaktu (aiz rozetes). (skat. lpp. 238/239 Apkopes režīms).

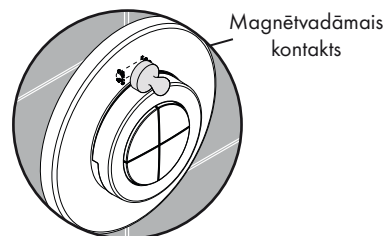

Raindance Rainfall

28411000

iControl mobile

15940180 / 15942000

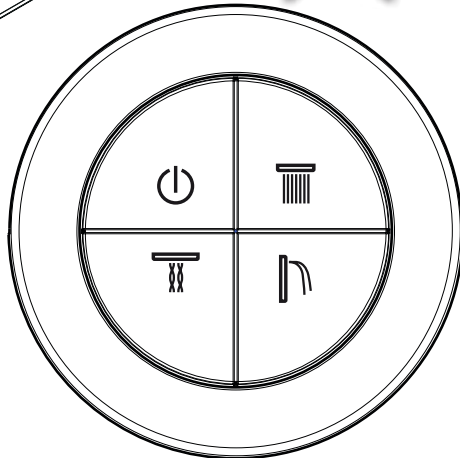
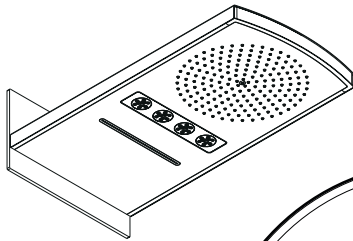

Raindance Rainfall

28411000

iControl mobile

15941180 / 15944000

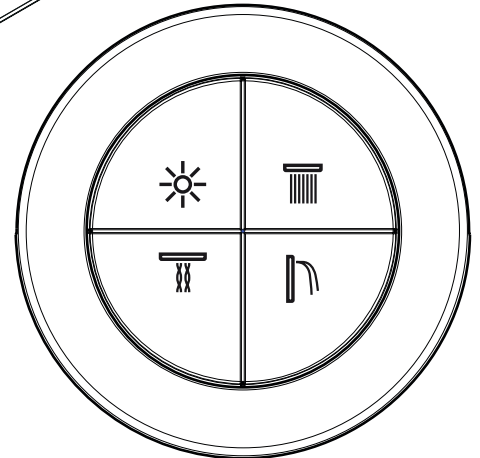
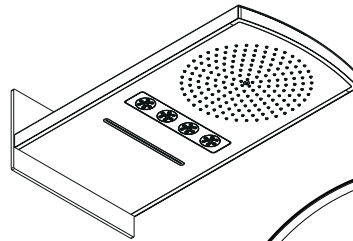

Raindance Rainmaker

28403000

iControl mobile

15940180 / 15943000

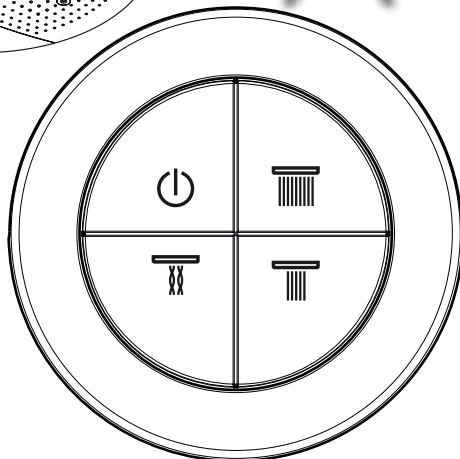
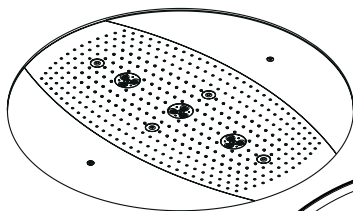

Raindance Rainmaker

28404000

iControl mobile

15941180 / 15945000

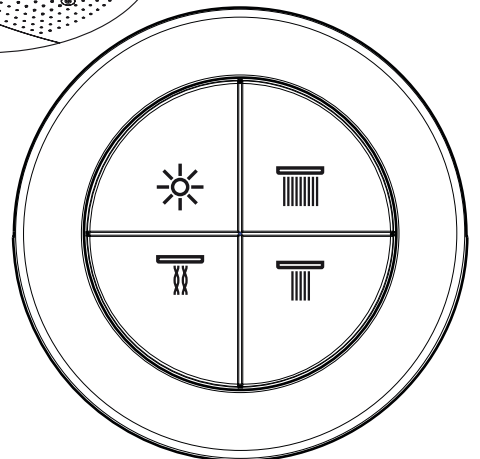
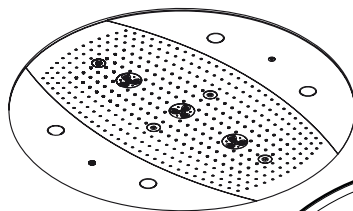

viss izslēgts



Rain



Whirl



Rainflow



Gaisma



Rain AIR XXL



Rain AIR

Ieslēgt un izslēgt dušas sprauslas un gaismu:

(Standartfunkcija ar gaismu)

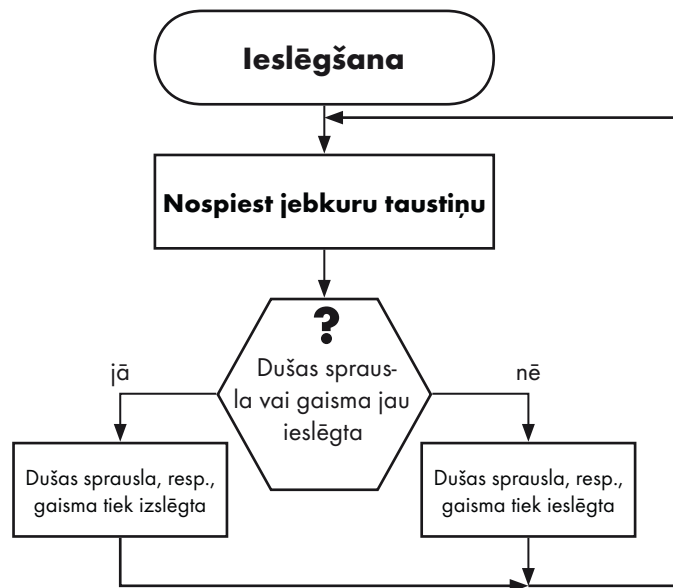

Ieslēgt un izslēgt sprauslu:

(Standartfunkcija bez gaismas)

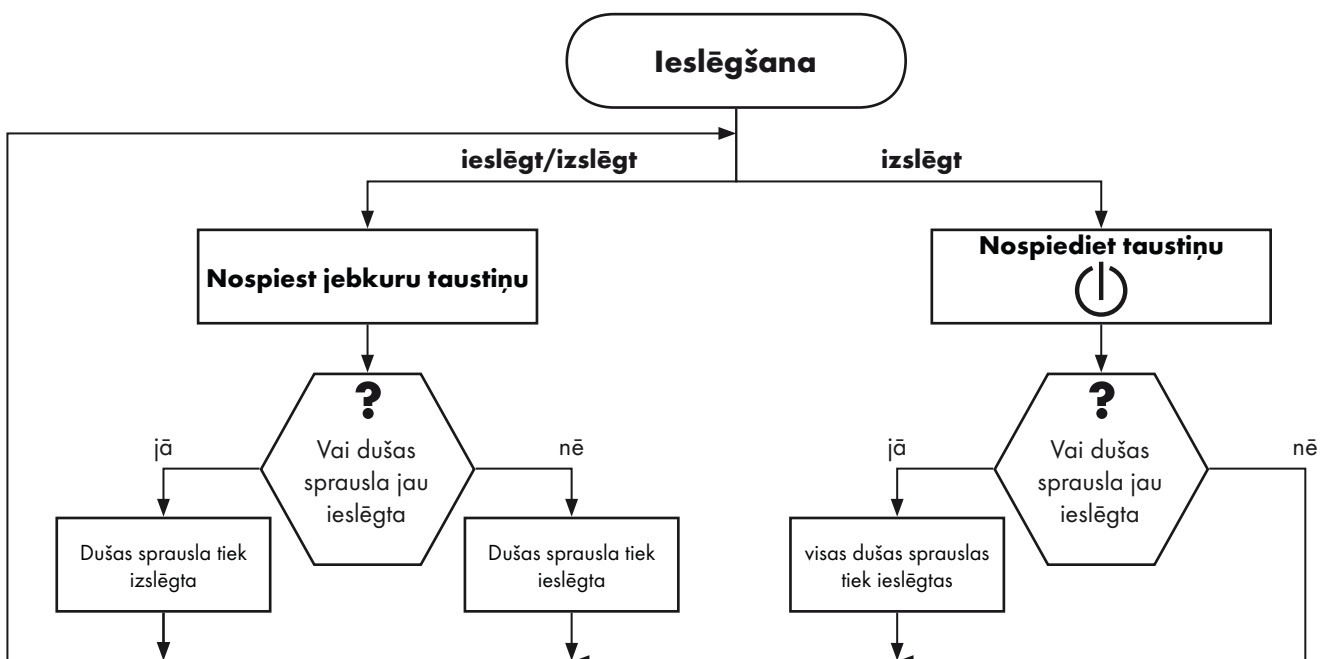

Latviski
Lietotāja līmenis

Raindance Rainfall
28411000

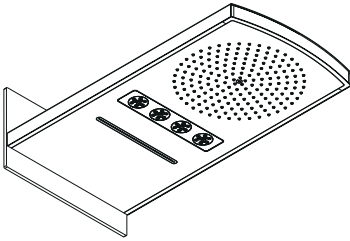

Darbības režīms

Norāde:
Visām dušas sprauslām
jābūt izslēgtām



Apkopes režīms

Norāde:
Gaisma/kodēšanas
spraudnis iedeģas 4x

Norāde:
Gaisma/kodēšanas
spraudnis iedeģas 2x

Norāde:
Gaisma/kodēšanas
spraudnis izslēdzas

< 15 sek.

> 15 sek.

Divas reizes noklikšķināt uz taustiņu vai

Divas reizes noklikšķināt uz taustiņu

Maksimālais darbības režīms

Norāde:
Gaisma/ kodēšanas spraudnis mirgo ar vienas sekundes intervālu

Dušas sprauslas režīms

Norāde:
Gaisma/ kodēšanas spraudnis mirgo ar vienas 2 sekundes intervālu

< 15 sek.

> 15 sek.

< 15 sek.

> 15 sek.

Nospiediet vai	Nospiediet taustiņu	Nospiediet taustiņu	Nospiediet taustiņu
--------------------------	----------------------------	----------------------------	----------------------------

Nospiediet vai	Nospiediet taustiņu
--------------------------	----------------------------

Ilgums: Dušas sprauslas: 30 s Gaisma: 30 min	Standarta: Ilgums: Dušas sprauslas: 60 s Gaisma: 30 min	Ilgums: Dušas sprauslas: 180 s Gaisma: 30 min	Ilgums: Dušas sprauslas+ gaisma: nebeidzami
--	---	---	---

Standarta maks. var tikt ieslēgtas 2 dušas sprauslas	Komforta 1: visas dušas sprauslas var tikt ieslēgtas vienlaicīgi
--	---

Latviski
Lietotāja līmenis

Raindance Rainmaker
28403000 / 28404000

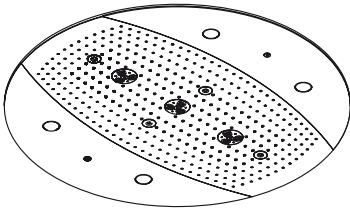

Darbības režīms

Norāde:
Visām dušas sprauslām jābūt izslēgtām



Apkopes režīms



Norāde:
Gaisma/kodēšanas spraudnis iedegas 4x

Norāde:
Gaisma/kodēšanas spraudnis iedegas 2x

Norāde:
Gaismas/kodēšanas spraudnis izslēdzas

< 15 sek.

> 15 sek.

Divas reizes noklikšķināt uz taustiņu  vai 

Divas reizes noklikšķināt uz taustiņu 

Maksimālais darbības režīms

Norāde:
Gaisma/ kodēšanas spraudnis mirgo ar vienas sekundes intervālu

Dušas sprauslas režīms





Norāde:
Gaisma/ kodēšanas spraudnis mirgo ar vienas 2 sekundes intervālu

< 15 sek.

> 15 sek.

< 15 sek.

> 15 sek.

Nospiediet  vai 	Nospiediet taustiņu 	Nospiediet taustiņu 	Nospiediet taustiņu 
--	---	---	---

Ilgums: Dušas sprauslas: 30 s Gaisma: 30 min	Standarta: Ilgums: Dušas sprauslas: 60 s Gaisma: 30 min	Ilgums: Dušas sprauslas: 180 s Gaisma: 30 min	Ilgums: Dušas sprauslas+ gaisma: nebeidzami
---	--	--	---

Nospiediet  vai 	Nospiediet taustiņu 	Nospiediet taustiņu 
--	---	---

Standarta maks. var tikt ieslēgtas 2 dušas sprauslas	Komforta 1: visas dušas sprauslas var tikt ieslēgtas vienlaicīgi	Komforta 2: Lielāks ūdens daudzums nepieciešams tikai Rainmaker
--	--	---

Latviski Speciālista līmenis

Raindance Rainfall
28411000

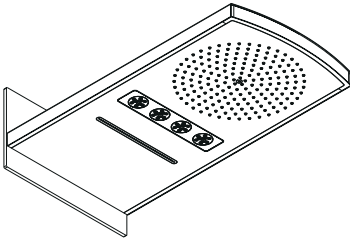

Darbības režīms

Norāde:
Visām dušas sprauslām
jābūt izslēgtām

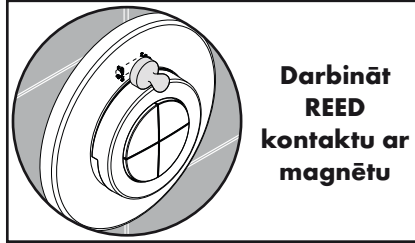

Apkopes režīms

Norāde:
Gaisma/kodēšanas
spraudnis iedegas 4x

Norāde:
Gaisma/kodēšanas
spraudnis iedegas 2x

Norāde:
Gaisma/kodēšanas
spraudnis izslēdzas

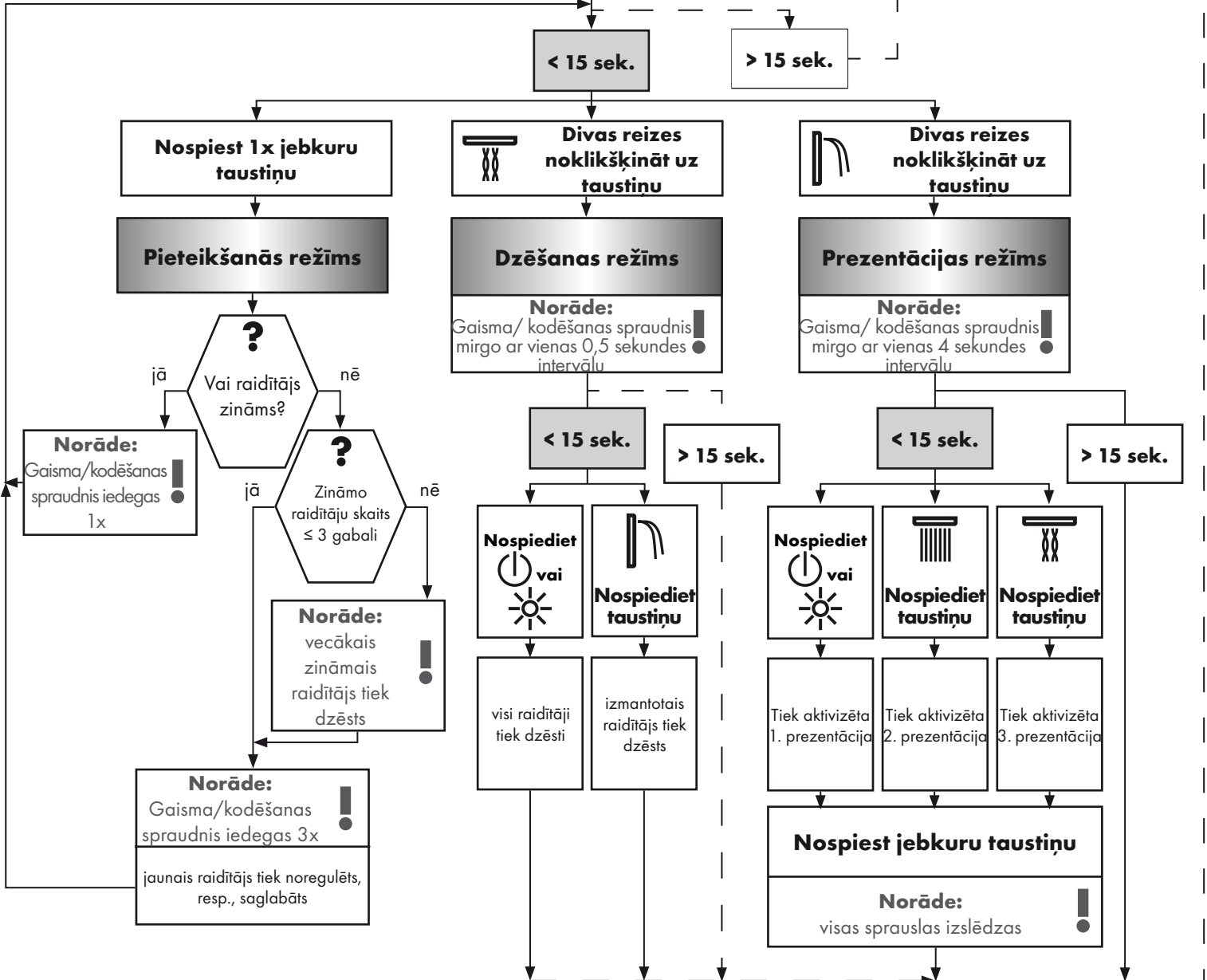

Latviski Speciālista līmenis

Raindance Rainmaker
28403000 / 28404000

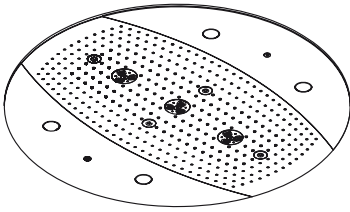

Darbības režīms

Norāde:
Visām dušas sprauslām jābūt izslēgtām

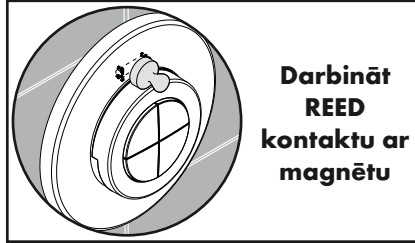

Apkopes režīms

Norāde:
Gaisma/kodēšanas spraudnis iedegas 4x

Norāde:
Gaisma/kodēšanas spraudnis iedegas 2x

Norāde:
Gaisma/kodēšanas spraudnis izslēdzas

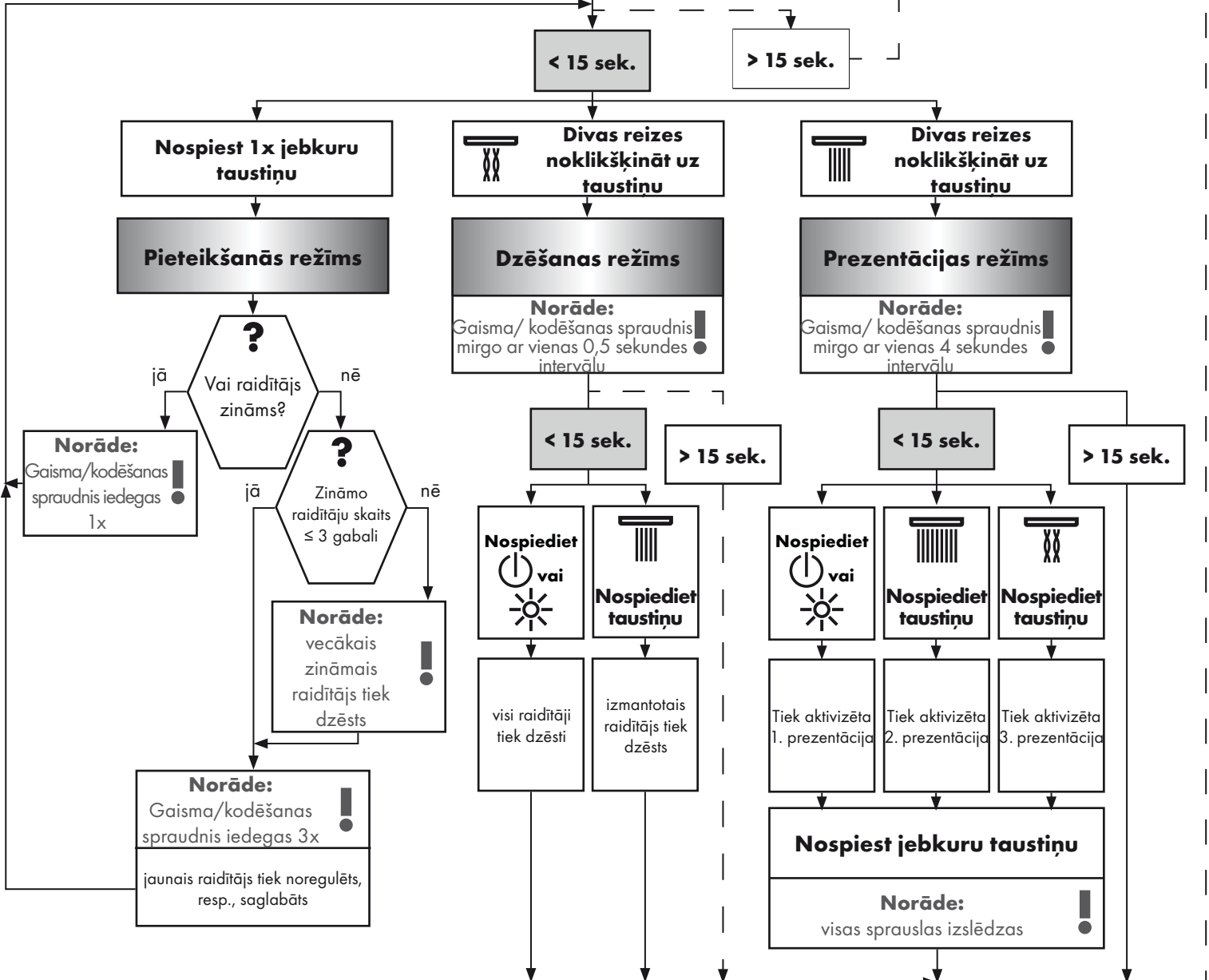

Norme i direktive:

Primenu proizvoda garantuju sledeće direktive:

- EN 15200
- EN 60335-2-105



Sigurnosne napomene:

- Proizvod sme da se koristi samo za kupanje, tuširanje i ličnu higijenu.
- Deca ne smeju da koriste sistem tuša bez nadzora.
- Deca, kao i telesno, mentalno i/ili senzorno hendikepirane odrasle osobe ne smeju da koriste sistem tuša bez nadzora. Osobe koje su pod uticajem alkohola ili droga ne smeju da koriste sistem tuša.
- Mora se izbegavati kontakt mlaza iz tuša sa osetljivim delovima tela (npr. očima). Telo korisnika mora biti na dovoljnom odstojanju od tuša.
- Velika razlika u pritisku između vruće i hladne vode mora biti izbalansirana.



Električni priključak:

- Instalaciju i ispitivanje smeju obavljati isključivo sertifikovani električari uz uvažavanje odredaba VDE 0100 deo 701 i IEC 60364-7-701.
- Za priključivanje u struju potrebna je samo jedna utičnica. Napajanje strujom sprovodi se preko spoljašnjeg transformatora.
- U neposrednoj blizini ne sme biti lako zapaljivih materijala.
- Temperatura okoline ne sme da bude veća od 50 °C.
- Celokupno napajanje strujom sprovodi se preko 230V/N/PE/50Hz priključka naizmenične struje.
- Vod se mora osigurati nadstrujnom zaštitnom sklopkom (RCD/FI) s nazivnom diferencijalnom strujom ≤ 30 mA.
- Ukoliko je potrebno izjednačenje potencijala, za to se treba pobrinuti klijent na licu mesta.
- Prilikom izvođenja električnih instalacionih radova treba se pridržavati odgovarajućih, trenutno važećih propisa stručnog udruženja elektrotehničara (u Nemačkoj: VDE), državnih propisa kao i propisa lokalne elektro-distribucije.
- Mora se obezbediti mogućnost odvajanja proizvoda sa električne mreže. To se može postići ili lako dostupnim utikačem ili višepolnim prekidačem u skladu sa EN 60335-1 st. 24.3.



Montaža: (vidi stranu 303)

- Pažnja! Armatura mora biti postavljena, isprana i testirana prema važećim normama. (Instalacija prema standardu EN 1717) Vidi uputstvo za montažu: Raindance Rainfall 28411000 Raindance Rainmaker 28403000 / 28404000 / 28417000 / 28418000
- Radovi bilo koje vrste smeju da se sprovedu samo u beznaponskom stanju.
- Moguća je samo vertikalna ugradnja tela 15941180! Montaža s prstenom za podešavanje (A) moguća je samo u prednjoj i centralnoj oblasti!
- Sve komponente moraju biti lako dostupne.

Tehnički podaci:

Radni pritisak::	maks. 1 MPa
Preporučeni radni pritisak:	0,1 - 0,5 MPa
Probni pritisak::	1,6 MPa
(1 MPa = 10 bar = 147 PSI)	
Temperatura vruće vode::	maks. 80 °C
Preporučena temperatura vruće vode:	65 °C
Rastojanje između centara priključaka:	G 3/4
Priključni ulaz:	Mešana voda
Slobodan protok na 0,3 MPa:	
1 Potrošač:	35 l/min
2 Potrošač:	45 l/min



Pribor: (vidi stranu 244)



Mere: (vidi stranu 292)



Primeri montaže Raindance Rainfall: (vidi stranu 295)



Primeri montaže Raindance Rainmaker: (vidi stranu 299)



Rukovanje: (vidi stranu 246)

- Tuš se ne može koristiti ako dođe do ispada 230 V mrežnog napona.
- Proizvod nije predviđen za upotrebu u parnim kupatilima!



Čišćenje Mrežica za hvatanje za prljavštine: (vidi stranu 309)



























Rezervni delovi (vidi stranu 311)

Montaža vidi stranu 303

Srpski Tehničke informacije

Smetnja	Uzrok	Pomoć
Bez ikakvih funkcija	<ul style="list-style-type: none"> - Nema dovoda napona - Transformator osnovne garnitura je u kvaru - Prijemnik nepovoljno pozicioniran / u kvaru - Predajnik nije podešen / u kvaru 	<ul style="list-style-type: none"> - Obezbedite dovod napona - Zamenite transformator - Premjestite ili zamenite prijemnik - Podesite / zamenite predajnik
Radni mod se ne može konfigurisati	<ul style="list-style-type: none"> - Reed kontakt nije na odgovarajućem položaju iza rozete - Reed kontakt neispravan 	<ul style="list-style-type: none"> - Postavite Reed kontakt na rozetu - Zamenite priključni vod magnetnog ventila
Nema funkcije svetla	<ul style="list-style-type: none"> - Transformator Rainmaker nije priključen ili je neispravan - Dovodi optičkog releja neispravni / u kvaru 	<ul style="list-style-type: none"> - Obezbedite dovod napona transformatora / zamenite transformator - Proverite / zamenite spojeve i optičke releje
Potrošači se samostalno isključuju	<ul style="list-style-type: none"> - Vreme protoka memorisano u programskom modu 	<ul style="list-style-type: none"> - Produžite / isključite naknadni tok u servisnom modu
Armatura ne zaptiva	<ul style="list-style-type: none"> - Magnetni ventil je prljav / neispravan 	<ul style="list-style-type: none"> - Očistite / zamenite membranu magnetnog ventila
Protok je premali	<ul style="list-style-type: none"> - Mrežica za hvatanje prljavštine na ulaznoj strani je zaprljana 	<ul style="list-style-type: none"> - Očistite / zamenite mrežicu za hvatanje prljavštine

Simbolima

	priključak za vodu DN 20 topla voda		transformator		Izjednačenje potencijala
	priključak za vodu DN 20 hladna voda		Prijemnik		sve isključeno
	Otvorite dotok vode		kodni utikač		svetlo
	Zatvorite dotok vode		230V		Rain
	Od • je funkcija zagarantovana.		12V		Whirl
	Kapacitet odvoda mora biti veći od 50 l/min. > 50 l/min		Šuplja cev		Rainflow
	Ispust Raindrain		Kontroler osvetljenja 27189000 (Nije sadržano u isporuci!)		Rain AIR XXL
	Sredina tuš-kada		Svetlosni relej Rainmaker		Rain AIR
			transformator Rainmaker		Silikon (ne sadrži sirćetnu kiselinu!)
			Postojeći priključak od 12 V za svetlo (maks. 80 W)		

Montaža vidi stranu 303

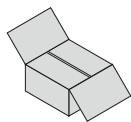

Srpski Pribor

Transformator:

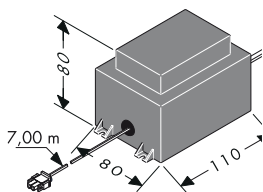

Snaga spoljašnjeg transformatora iznosi 50 VA. Transformator mora da se instalira u suvoj zoni (zaštitna zona 3). Transformator se zajedno s prijemnikom može ugraditi u plastično kućište, pri čemu se mora uvažiti odredba EN/IEC 60335-1. ((dimenzija ca. 250 x 160 x 92 mm), nije sadržana u isporuci.) Isporučeni kabl omogućava instalaciju transformatora na udaljenosti do 7,00 m od prijemnika. U tu se svrhu mora predvideti jedna prazna cev EN35 (nije sadržana u isporuci). Prazna cev se mora fiksirati najviše na svakih 500 mm, a poluprečnik savijanja mora biti veći od 100 mm.

Sekundarni vod transformatora dugačak oko 7,00 m se ne sme skraćivati. Nepotrebnu dužinu

treba ostaviti u blizini sigurnosnog transformatora. Oštećeni priključni vod se ne sme zamenjivati. U tom slučaju se transformator ne sme više uključivati. Oštećeni priključni vod se ne sme zamenjivati. U slučaju kvara strujnog priključnog voda, kvalifikovani električar mora da zameni čitav vod zajedno sa transformatorom.

Svetlosni relej:

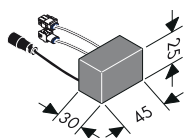

(samo kod varijanti sa ugrađenim svetlom)
Opterećenje releja ne sme biti veće od 12 V AC / 80 W.
Nije dozvoljeno direktno priključivanje na mrežni napon od 230 V.

Kontroler osvetljenja: 27189000

(Nije sadržano u isporuci)

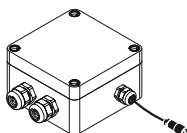

(iControl mobile 15944000)
Kontroler osvetljenja mora da se priključi kod varijanti s spoljašnjim izvorom svetla. Kontroler osvetljenja mora u svako doba biti dostupan.

Kodni utikač:

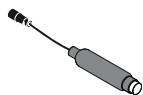

(Raindance Rainfall 28411000 / Raindance Rainmaker 28403000)
Kod varijanti bez svetla, mora se priključiti kodni utikač.
Ako je kod varijanti bez svetla aktivan servisni mod, LED indikator na kodnom utikaču svetli. Kodni utikač mora u svako doba biti dostupan.

Priključni vod blok magnetskih ventila / Priključni vod svetlo:



Vod bloka magnetskih ventila dugačak 7,50 m, te svetlosni vod dužine 10,00 m, se ne smeju skraćivati. Nepotrebnu dužinu treba ostaviti u blizini prijemnika.

Vod bloka magnetskog ventila i svetlosni vod se smeju polagati samo u isporučenu praznu cev (EN 20).

Prazna cev se mora fiksirati najviše na svakih 500 mm, a poluprečnik savijanja mora biti veći od 100 mm.

Pažnja: U praznoj cevi za vod bloka magnetskih ventila i svetlosni vod se ne smeju polagati električni vodovi napona većeg od 12 V.

Montaža vidi stranu 303

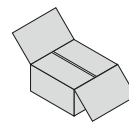

Prijemnik:

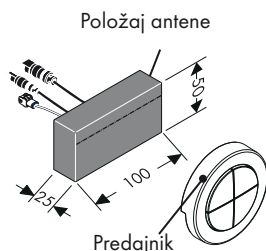

Prijemnik je poželjno montirati u istoj prostoriji u kojoj se nalazi i deo za tuširanje.

Ako to nije moguće, prijemnik se može montirati i u susednoj prostoriji.

Prijemnik se ne sme ugrađivati u metalno kućište, jer bi ono onemogućilo radiosignal predajnika. Takođe, mora se obratiti pažnja da se što manje metalnih delova, koji ometaju prijem signala, nalazi u blizini mesta ugradnje prijemnika.

Radi optimalnog prijema radiosignala, antenu prijemnika treba okrenuti prema predajniku.

Predajnik:



Prijemnik je pri isporuci već podešen na prijem signala s odgovarajućeg predajnika. Takođe, predajnik i prijemnik su, radi lakšeg prepoznavanja, označeni istim serijskim brojem.

Ukoliko se želi prijem signala s dodatnih, odnosno naknadno kupljenih predajnika, prijemnik se mora posebno podesiti. Maksimalno je moguće podešavanje prijema, odnosno pamćenje, četiri predajnika. (vidi stranu 250/251 Mod za prijavljivanje).

Predajna frekvencija iznosi 868,3 MHz.

Napomena: Domet predajnika i prijemnika iznosi ca. 10,00 m. Tačna vrednost zavisi od stepenu prigušenja signala između predajnika i prijemnika.

Napomena: Iz bezbednosnih razloga koristite predajnik samo u vidnom polju sistema tuša. U suprotnom bi se voda mogla nehotice pustiti.

Napomena: Pravilan postupak pri zameni neispravnog predajnika novim:

1. Izbrisati sve predajnike. (Mod za prijavljivanje ⇒ Mod za brisanje).
2. Izvršiti prepoznavanje svih predajnika, osim neispravnog. (Mod za Servisni ⇒ Mod za prijavljivanje).

materijal	prigušenje
drvo, gips, staklo (neobložen, bez metala)	0 - 10 %
cigla, pločasti drveni materijali	5 - 35 %
beton s čeličnom armaturom	10 - 90 %
metal, izolaciona aluminijumska folija	90 - 100 %

magnet:



Za pokretanje servisnog moda magnet mora da aktivira REED kontakt (iza rozete). (vidi stranu 248/249, Mod za Servisni).

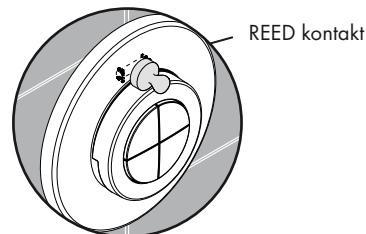

Raindance Rainfall

28411000

iControl mobile

15940180 / 15942000

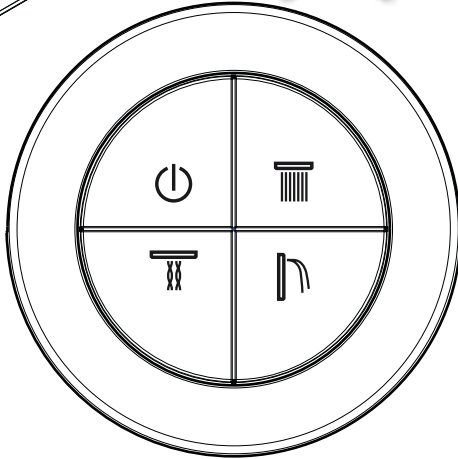
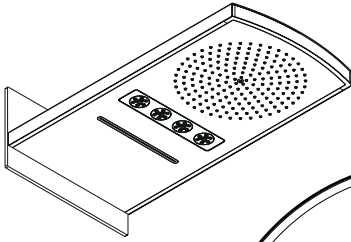

Raindance Rainfall

28411000

iControl mobile

15941180 / 15944000

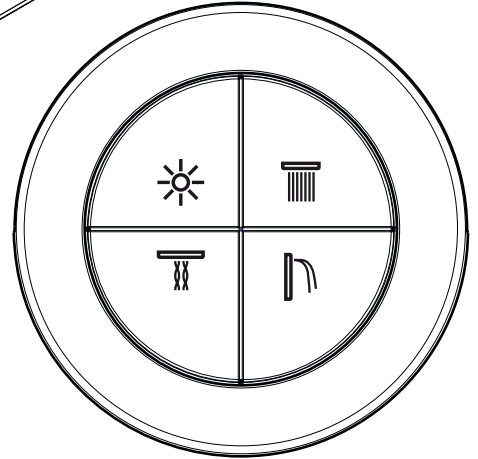
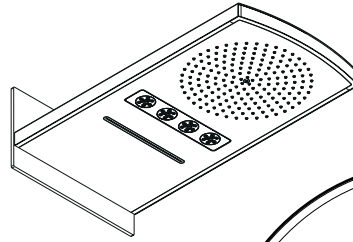

Raindance Rainmaker

28403000

iControl mobile

15940180 / 15943000

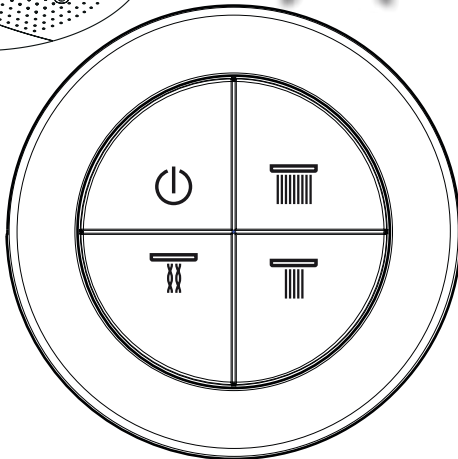
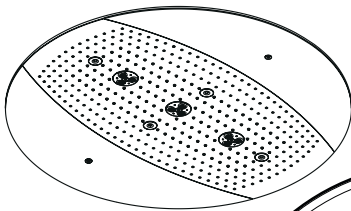

Raindance Rainmaker

28404000

iControl mobile

15941180 / 15945000

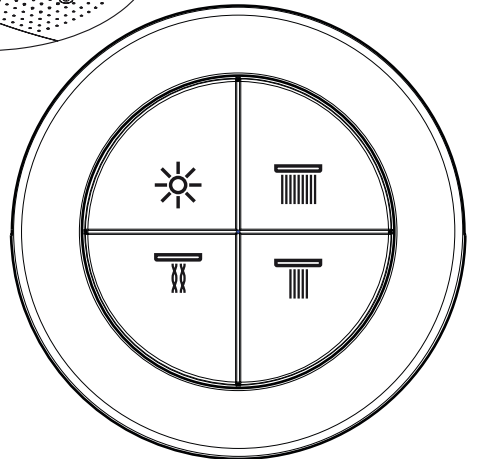
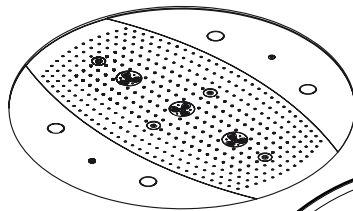

sve isključeno



Rain



Whirl



Rainflow



svetlo



Rain AIR XXL



Rain AIR

Montaža vidi stranu 303

Uključite i isključite tuševe i svetlo:

(Standardna funkcija sa svetlom)

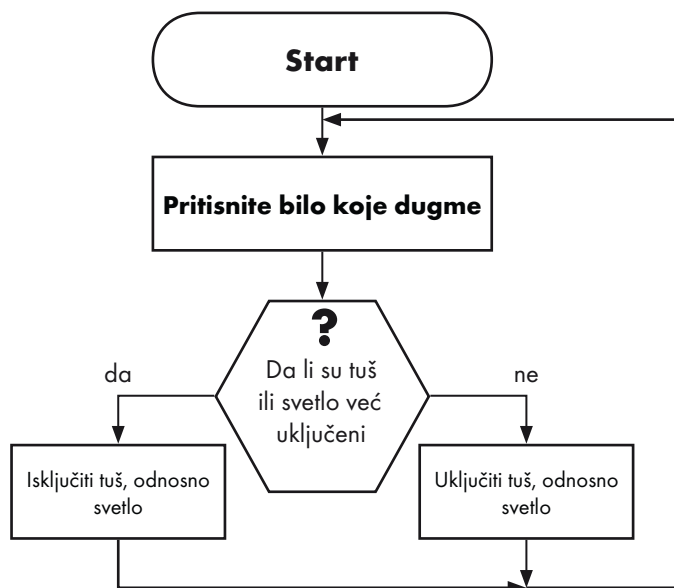

Uključivanje i isključivanje tuševa:

(Standardna funkcija bez svetla)

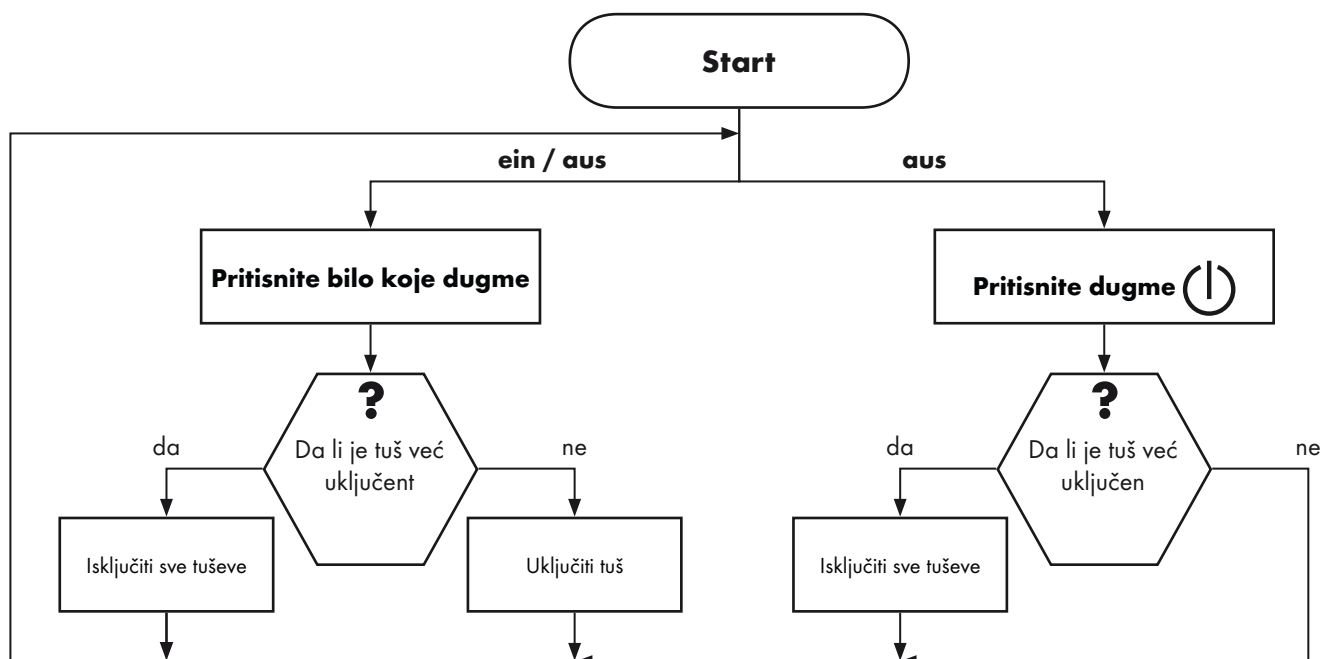

Montaža vidi stranu 303

**Srpski
Korisnički nivo**

Raindance Rainfall
28411000

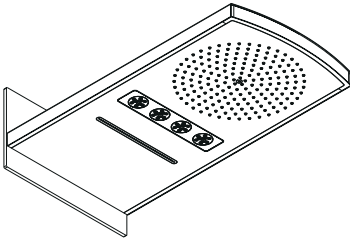

Radni mod

Napomena:
Svi tuševi moraju biti
isključeni



Mod za Servisni

Napomena:
svetlo / kodni utikač
treperi 4 x

Napomena:
svetlo / kodni utikač
treperi 2 x

Napomena:
svetlo / kodni utikač se gasi

< 15 s.

> 15 s.

dva puta pritisnite dugme
⏻ ili ☀️

**dva puta pritisnite
dugme**

**Mod s maksimalnim
vremenom protoka**

Napomena:
svetlo / kodni utikač
treperi 1 put u sekundi

Mod za tuširanje

Napomena:
svetlo / kodni utikač
treperi 2 put u sekundi

< 15 s.

> 15 s.

< 15 s.

> 15 s.

**Pritisnite
dugme**
⏻ ili ☀️

**Pritisnite
dugme**

**Pritisnite
dugme**

**Pritisnite
dugme**

**Pritisnite
dugme**
⏻ ili ☀️

**Pritisnite
dugme**

**Vremena
protoka:**
tuševi: 30 s
svetlo: 30 min

standard:
**Vremena
protoka:**
tuševi: 60 s
svetlo: 30 min

**Vremena
protoka:**
tuševi: 180 s
svetlo: 30 min

**Vremena
protoka:**
tuševi + svetla:
beskonačno

standard
mogu se uključiti
najviše dva tuša

komfor 1:
svi tuševi
se mogu
istovremeno
uključiti

Srpski Korisnički nivo

Raindance Rainmaker
28403000 / 28404000

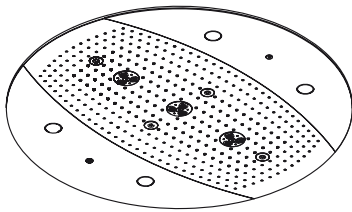

Radni mod

Napomena:
Svi tuševi moraju biti
isključeni



Mod za Servisni

Napomena:
svetlo / kodni utikač
treperi 4 x

Napomena:
svetlo / kodni utikač se gasi

Napomena:
svetlo / kodni utikač
treperi 2 x

< 15 s.

> 15 s.

dva puta pritisnite dugme
⏻ ili ☀️

**dva puta pritisnite
dugme**

**Mod s maksimalnim
vremenom protoka**

Napomena:
svetlo / kodni utikač
treperi 1 put u sekundi

Mod za tuširanje

Napomena:
svetlo / kodni utikač
treperi 2 put u sekundi

< 15 s.

> 15 s.

< 15 s.

> 15 s.

Pritisnite dugme ⏻ ili ☀️	Pritisnite dugme ☔	Pritisnite dugme ☔	Pritisnite dugme ☔
---	----------------------------------	----------------------------------	----------------------------------

Vremena protoka: tuševi: 30 s svetlo: 30 min	standard: Vremena protoka: tuševi: 60 s svetlo: 30 min	Vremena protoka: tuševi: 180 s svetlo: 30 min	Vremena protoka: tuševi + svetla: beskonačno
---	--	--	---

Pritisnite dugme ⏻ ili ☀️	Pritisnite dugme ☔	Pritisnite dugme ☔
---	----------------------------------	----------------------------------

standard mogu se uključiti najviše dva tuša	komfor 1: svi tuševi se mogu istovremeno uključiti	komfor 2: veća količina vode, potrebna samo za rainmaker
---	---	---

Srpski Ekspertni nivo

Raindance Rainfall
28411000

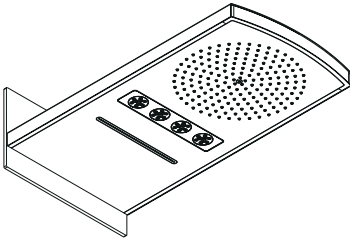

Radni mod

Napomena:
Svi tuševi moraju biti
isključeni



Mod za Servisni
Napomena:
svetlo / kodni utikač
treperi 4 x

Napomena:
svetlo / kodni utikač
treperi 2 x

Napomena:
svetlo / kodni utikač se gasi

< 15 s.

> 15 s.

1 x pritisnite bilo koje
dugme

Mod za prijavljivanje

Da li je
predajnik
prepoznat?

Napomena:
svetlo / kodni
utikač
treperi 1 x

Broj
prepoznatih
predajnika ≤ 3
komada

Napomena:
briše se najduže
prepoznati
predajnik

Napomena:
svetlo / kodni utikač
treperi 3 x
traži se, odnosno pamti, novi
predajnik

dva puta pritisnite
dugme

Mod za brisanje
Napomena:
svetlo / kodni utikač
treperi 0,5 put u sekundi

< 15 s.

> 15 s.

Pritisnite
dugme
ili

Pritisnite
dugme

svi predajnici
se brišu

briše se
korišćeni
predajnik

dva puta pritisnite
dugme

Prezentacioni mod
Napomena:
svetlo / kodni utikač
treperi 4 put u sekundi

< 15 s.

> 15 s.

Pritisnite
dugme
ili

Pritisnite
dugme

Pritisnite
dugme

počinje
prezentacija 1

počinje
prezentacija 2

počinje
prezentacija 3

Pritisnite bilo koje dugme
Napomena:
svi tuševi se gasi

Srpski Ekspertni nivo

Raindance Rainmaker
28403000 / 28404000

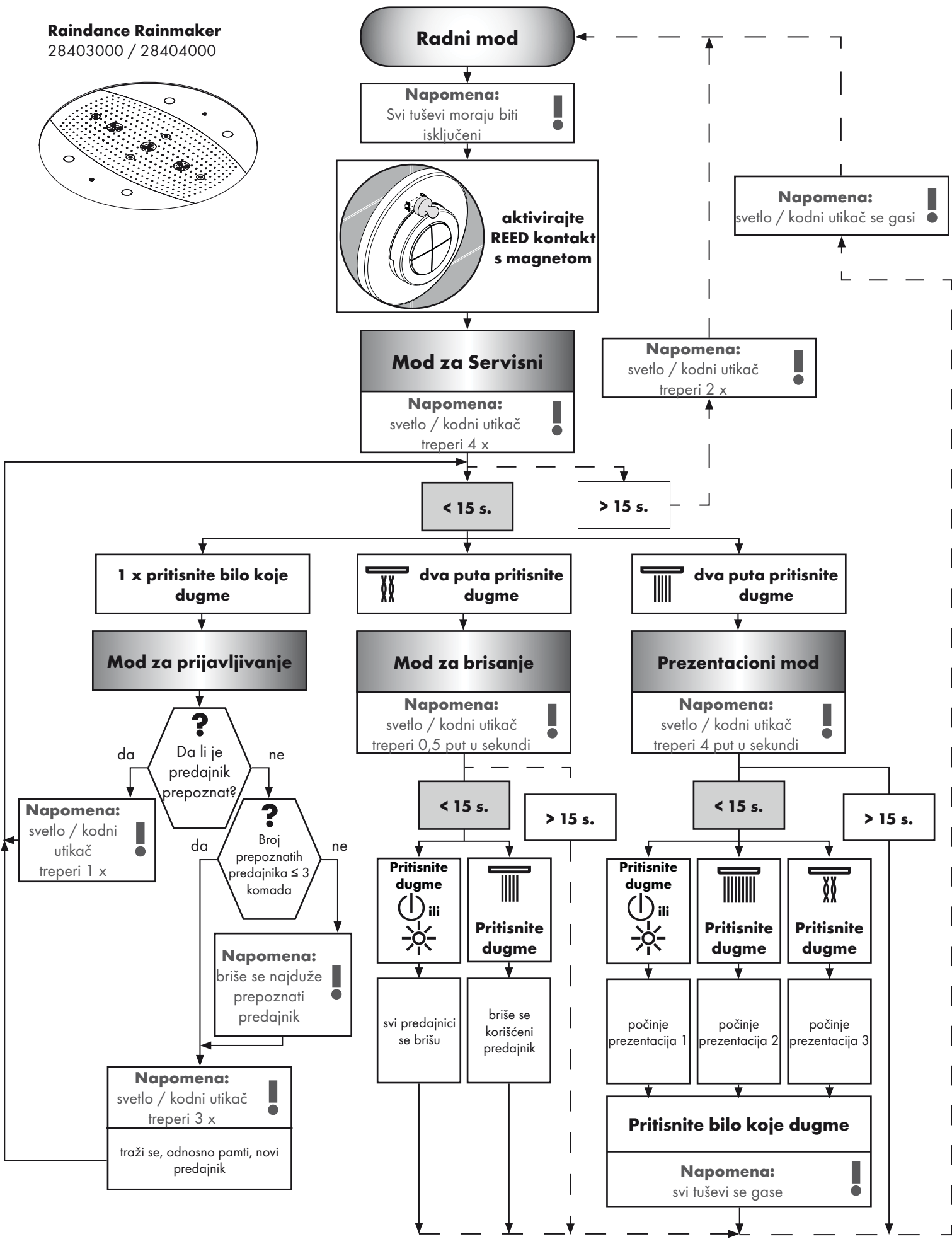
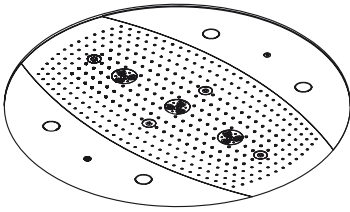

Standarder og direktiver:

Bruken av produktet garanteres av følgende direktiv:

- EN 15200
- EN 60335-2-105



Sikkerhetshenvisninger:

- Dusjsystemet skal kun brukes for bade-, hygiene- og kroppshygiene.
- Barn må ikke bruke dusj systemet uten oppsyn.
- Barn og voksne med fysiske og psykiske og/eller sensoriske handicap skal ikke bruke dusjsystemet uten oppsyn. Personer som er påvirket av alkohol eller narkotika skal ikke bruke dusjsystemet.
- Dusjstrålen skal ikke komme i kontakt med ømfintlige kroppsdeler (f.eks. øynene). Overhold en tilstrekkelig avstand mellom dusjen og kroppen.
- Store trykkdifferanser mellom kaldt- og varmtvannstilkoblinger skal utlignes.



El-tilkoblinger:

- Installasjons- og kontrollarbeid skal utføres av en godkjent el-fagbedrift som overholder direktiv VDE 0100 del 701 og IEC 60364-7-70101.
- For elektrisk tilkobling er det kun nødvendig med én stikk-kontakt. Strømforsyning via ekstern transformator.
- I umiddelbar nærhet må det ikke finns materialer som er lett antennelig.
- Omgivelsestemperaturen skal ikke være mer enn 50 °C.
- Hele strømforsyningen utføres via en 230V/NPE/50Hz vekselstrømtilkobling.
- Installasjonen skal sikres ved hjelp av en jordfeilbryter (RCD/FI) dimensjonert for en reststrøm på ≤ 30 mA.
- Hvis det er nødvendig med en potensialutjevning, skal dette gjøres på byggeplassen.
- Ved el-installasjonen skal de tilsvarende gyldige VDE-, nasjonale og EVU-forskrifter overholdes.
- Det må kunne garanteres, at produktet kan skilles fra nettet. Enten ved hjelp av en fritt tilgjengelig kontakt eller ved hjelp av en allpolig bryter iht. EN 60335-1 ledd 24.3.



Montasje: (se side 303)

- Obs! Armaturen skal monteres, spyles og sjekkes iht. gyldige standarder. (Installasjon iht. EN 1717)
Se montasjeveiledning:
Raindance Rainfall 28411000
Raindance Rainmaker 28403000 / 28404000 / 28417000 / 28418000
- Alt arbeid skal kun utføres i spenningsløs tilstand.
- Basiskabinettet 15941180 kan kun bygges inn loddrett!
Montasje med justeringsring (A) er kun mulig i området foran og i midten!
- Alle komponenter skal være tilgjengelige.

Tekniske data:

Driftstrykk:	maks. 1 MPa
Anbefalt driftstrykk:	0,1 - 0,5 MPa
Prøvetrykk:	1,6 MPa
(1 MPa = 10 bar = 147 PSI)	
Varmtvannstemperatur:	maks. 80 °C
Anbefalt temperatur for varmt vann	65 °C
Tilkoblingsmål:	G 3/4
Tilkoblinger fritt utløp:	Blandingsvann
Fri gjennomstrømning ved 0,3 MPa:	
1 Forbruker:	35 l/min
2 Forbruker:	45 l/min



Tilbehør: (se side 254)



Mål: (se side 292)



Montasje-eksempel Raindance Rainfall: (se side 295)



Montasje-eksempel Raindance Rainmaker: (se side 299)



Betjening: (se side 256)

- Ved svikt av 230 V nettspenning kan dusjanlegget ikke settes i drift.
- Produktet er ikke påtenkt for bruk sammen med et dampbad!



Rengjøring Smussfiltersil: (se side 309)





























Reservedeler (se side 311)

Montasje se side 303

Norsk Teknisk informasjon

Feil	Årsak	Feilrettelse
Ingen funksjon	- ingen spenningsforsyning - Transformator i basissett defekt - Mottaker dårlig posisjonert / defekt - Sender ikke innlært / defekt	- Sikre spenningsforsyning - Transformator erstattes - Mottakerposisjon forandres hhv. erstattes mottaker - Lære inn sender / erstattes
Driftsmodus kan ikke konfigureres	- Reedkontakt ikke i egnet posisjon bak rosetten - Feil på reedkontakt	- Posisjoner reedkontakten på rosetten - Tilkoblingsledning for magnetventil erstattes
Ingen lysfunksjon	- Rainmaker transformator ikke påkoblet / feilaktig - Forsyningsledninger for lysrelé feilaktig / defekt	- Sikre spenningsforsyning for transformator / transformator erstattes - Sjekk forbindelser og lysrelé / erstattes
Forbrukere slår seg av selvstendig	- Innkoblingstid lagret i programmodus	- Etterløpstid forlenges i service-modus / slå av
Armatyr utett	- Magnetventil skitten / defekt	- Rengjør magnetventilmembran / erstattes
For lite gjennomstrømning	- Smussfilter på inngangssiden skittent	- Smussfangersil rengjøres / byttes

Symboler

 Vanntilkobling DN 20 Varmtvann	 Transformator	 Potensialutjevning
 Vanntilkobling DN 20 Kaldtvann	 Mottaker	 alt av
 Vann settes på	 Koderingskontakt	 Lys
 Slå av vann	 230V	 Rain
 F.o.m. • er funksjonen garantert	 12V	 Whirl
 Avløp ytelse skal være mer enn 50 l/min. > 50 l/min	 Tomrør	 Rainflow
 Avløp	 Lyskontroll 27189000 (ikke medlevert!)	 Rain AIR XXL
 Raindrain	 Lysréleer Rainmaker	 Rain AIR
 Midten på dusjkar	 Transformator Rainmaker	 Silikon (uten eddiksyre)
	 På monteringsstedet forhåndsinstallert 12 V tilkobling for lys (maks. 80 W)	

Montasje se side 303

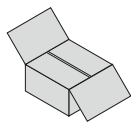

Norsk Tilbehør

Transformator:

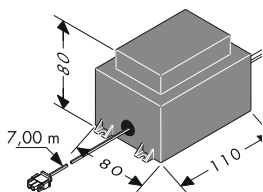

Effekten til ekstern transformator er på 50 VA. Transformatoren skal installeres på et tørt sted (vernesone 3). Ved å overholde direktiv EN/IEC 60335-1 kan transformatoren og mottakeren bygges inn i et plastkabinett. (dimensjoner omtrent 250 x 160 x 92 mm, følger ikke med.) Kabelen som følger med tillater en installasjon av transformatoren i en avstand på 7,00 m fra mottakeren. For det må det brukes et tomrør EN35 (følger ikke med). Tomrøret skal festes alle 500 mm og bøyeradius må ikke være større enn 100 mm.

Den omtrent 7,00 m lange sekundærledningen til transformatoren må ikke kortes ned. Ledningen som ikke brukes skal oppbevares i nærheten av transformatoren. En skadet tilkoblingsledning skal

ikke erstattes. Deretter skal transformatoren ikke settes i drift.

Ledningen for denne transformatorens strømtilkobling kan ikke erstattes. Når ledningen for nettilkoblingen er defekt, skal den, sammen med transformatoren, erstattes av el-fagfolk.

Lysréleer:

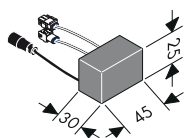

(kun for varianter med integrert lys)

Lysréleer skal maks. belastes med 12 V AC / 80 W.

En drift med 230 V nett er ikke tillatt.

Lyskontroll:

27189000

(ikke med i leveransen)

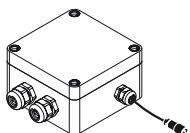

(iControl mobile 15944000)

Ved varianter med ekstern lyskilde skal lystyring tilkobles. Lysstyringen skal alltid være tilgjengelig.

Koderingskontakt:

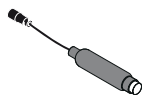

(Raindance Rainfall 28411000 / Raindance Rainmaker 28403000)

Ved variantene uten lys må koderingskontakten tilkobles.

Når service-modus er aktivert hos variantene uten lys, viser koderingskontaktens lysdiode en tilbakemelding.

Koderingskontakter skal alltid være tilgjengelige.

Tilkoblingsledning Magnetventilblokk / Tilkoblingsledning Lys:



Den 7,50 m lange ledningen til magnetventilblokken og den 10,00 m lange lysledningen skal ikke kortes ned. Ledninger som ikke behøves bør lagres i nærheten av mottakeren.

Ledningen til magnetventilblokken og lysledningen skal kun trekkes i det medleverte tomrøret (EN 20).

Tomrøret skal festes alle 500 mm og bøyeradius må ikke være større enn 100 mm.

Obs: I tomrør for ledningen til magnetventilblokken og lysledningen skal man ikke trekke elektriske ledninger med en spenning som er større enn 12 V.

Montasje se side 303

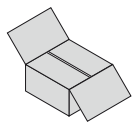

Mottaker:

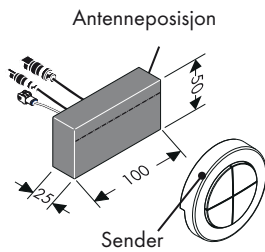

Det anbefales å installere mottakeren i samme rom som dusjanlegget.
Hvis dette ikke er mulig, kan mottakeren også installeres i et rom ved siden av dusjanlegget.
Mottakeren må ikke bygges inn i et metallkabinett. Ellers skjermes radiosignaler til senderen. Videre skal man påse at det finns så få metalldeleer som mulig, som avskjermer i nærheten av monteringsstedet til mottakeren.

For en optimal mottakelse av radiosignaler anbefales det at mottakerens antenne er rettet imot senderen.

Sender:



Ved utleveringen er senderen allerede innlært på mottakeren. Senderen kan tilordnes mottakeren ved hjelp av de identiske serienummere.
Ekstra sendere og sendere som kjøpes senere skal innlæres. Maksimalt kan det innlæres hhv. lagres fire sendere. (se side 260/261 Påmeldingsmodus).
Senderens radiofrekvens er på 868,3 MHz

Henvising: Mottaker og sender har en rekkevidde på omtrent 10,00 m. Rekkevidden er avhengig av hvor sterkt radiosignaler mellom sender og mottaker blir dempet.

Henvising: Av sikkerhetsmessige årsaker skal senderen kun brukes innenfor dusj-systemets synsområde. Ellers kan vannet slå seg på ved en feiltagelse.

Henvising: Riktig fremgangsmåte ved erstatning av en defekt sender med en ny sender.

1. Slette alle sendere (Påmeldingsmodus ⇒ Slettemodus).
2. Bortsett fra den defekte senderen innlæres alle sendere på ny. (Service-modus ⇒ Påmeldingsmodus).

Material	Demping
Tre, gips, glass (ubeskittet, uten metall)	0 - 10 %
Teglstein, sponplater	5 - 35 %
Betong med jernarmering	10 - 90 %
Metall, forkledning av aluminium	90 - 100 %

Magnet:



For aktivering av service-modus skal magneten koble REED-kontakten (bak rosetten). (se side 258/259, Service-modus).

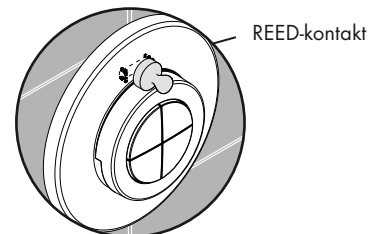

Norsk Betjening

Raindance Rainfall

28411000

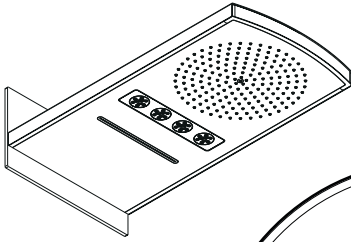

iControl mobile

15940180 / 15942000

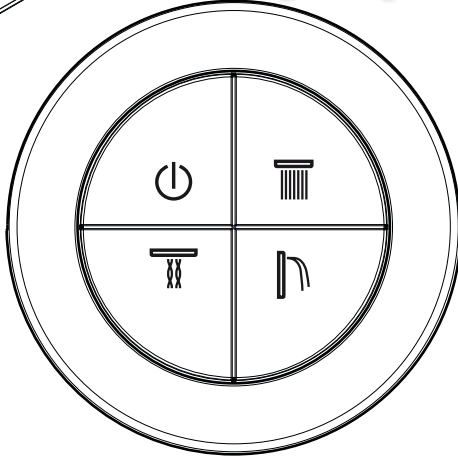

Raindance Rainfall

28411000

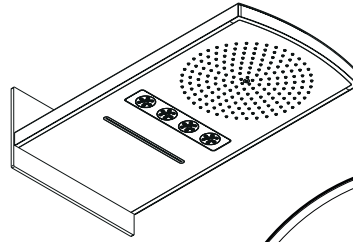

iControl mobile

15941180 / 15944000

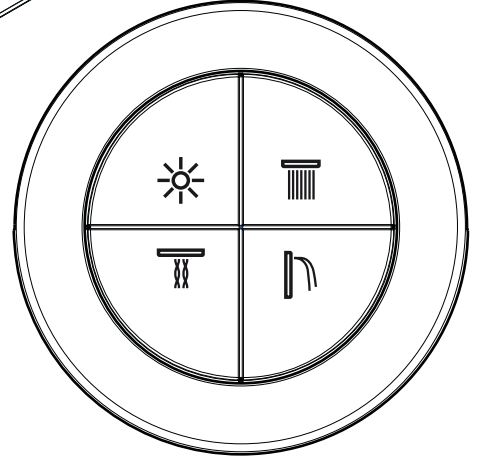

Raindance Rainmaker

28403000

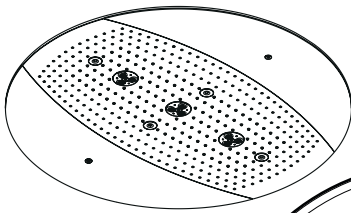

iControl mobile

15940180 / 15943000

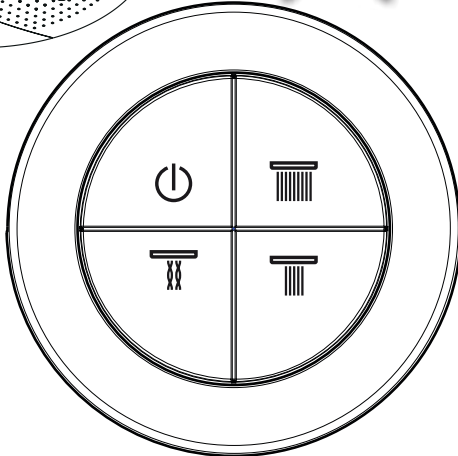

Raindance Rainmaker

28404000

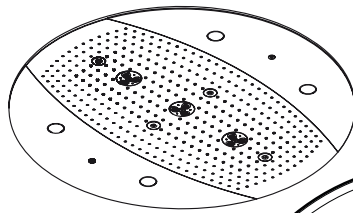

iControl mobile

15941180 / 15945000

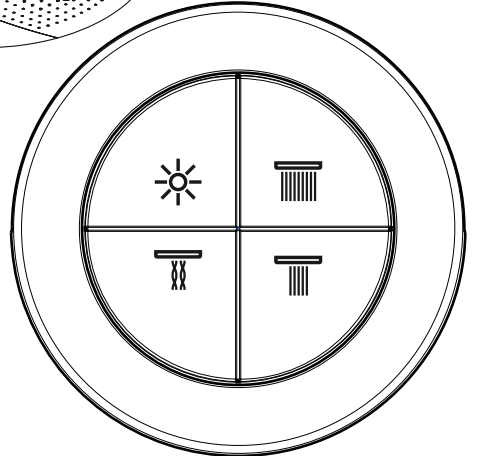

alt av



Rain



Whirl



Rainflow



Lys



Rain AIR XXL



Rain AIR

Montasje se side 303

Slå på og av dusj og lys:

(Standardfunksjon med lys)

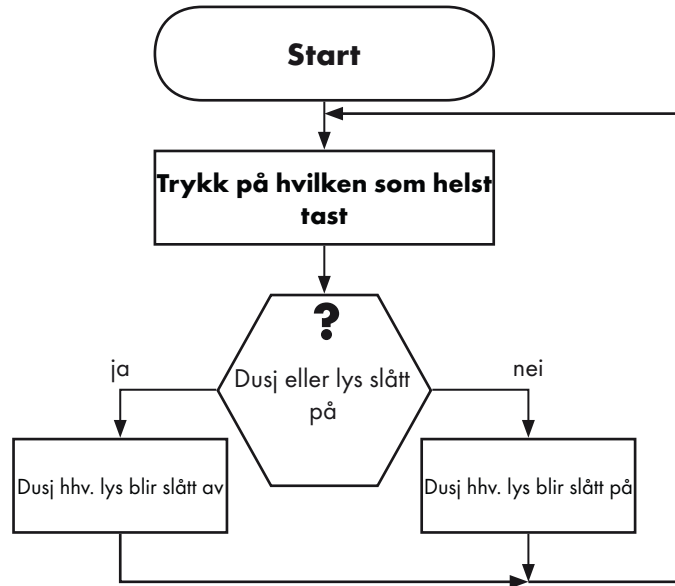

Slå på og av dusj:

(Standardfunksjon uten lys)

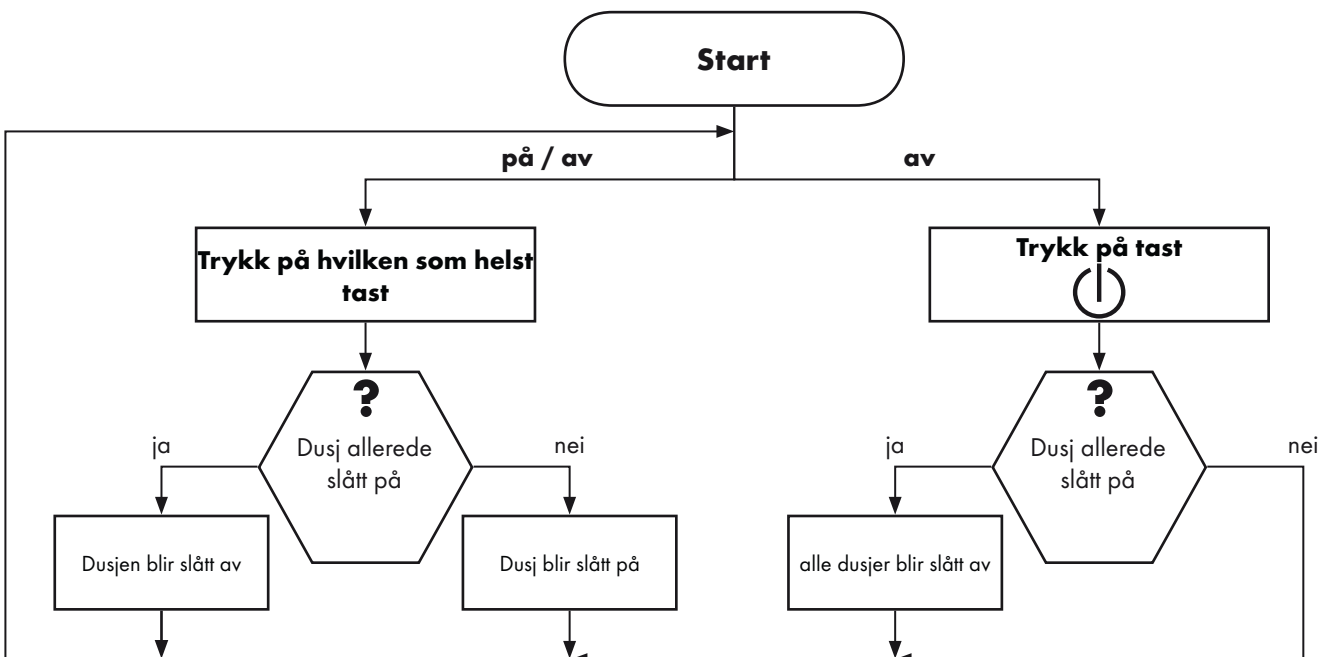

Norsk Betjener-nivå

Raindance Rainfall
28411000

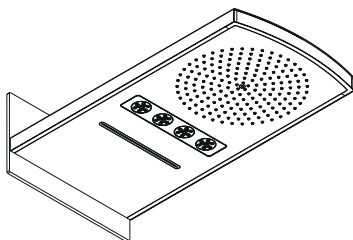

Drifts-modus

Henvising:
Alle dusjer må være slått av

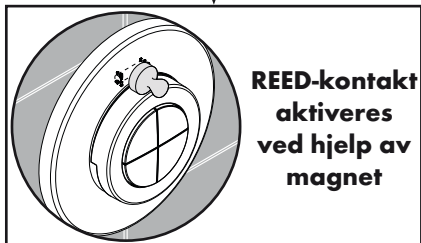

Service-modus
Henvising:
Lys / koderingskontakt
blinker 4x

Henvising:
Lys / koderingskontakt slår
seg av

Henvising:
Lys / koderingskontakt
blinker 2x

< 15 sek.

> 15 sek.

Dobbelklikk på tast
⏻ eller ☀️

Dobbelklikk på tast

**Modus for maksimal
kjøretid**
Henvising:
Lys / koderingskontakt blin-
ker hvert sekund

Dusj-modus
Henvising:
Lys / koderingskontakt blin-
ker 2 sekund

< 15 sek.

> 15 sek.

< 15 sek.

> 15 sek.

Trykk på
tast ⏻
ellerr ☀️

Trykk på
tast

Trykk på
tast

Trykk på
tast

Trykk på
tast ⏻
ellerr ☀️

Trykk på
tast

Kjøretider:
Dusje: 30 s
Lys: 30 min

Standard:
Kjøretider:
Dusje: 60 s
Lys: 30 min

Kjøretider:
Dusje: 180 s
Lys: 30 min

Kjøretider:
Dusje + lys
uendelig

Standard
maks. 2 dusjer
kan innkobles

Komfort 1:
alle dusjer
kan slås på
samtidig

Norsk Betjener-nivå

Raindance Rainmaker
28403000 / 28404000

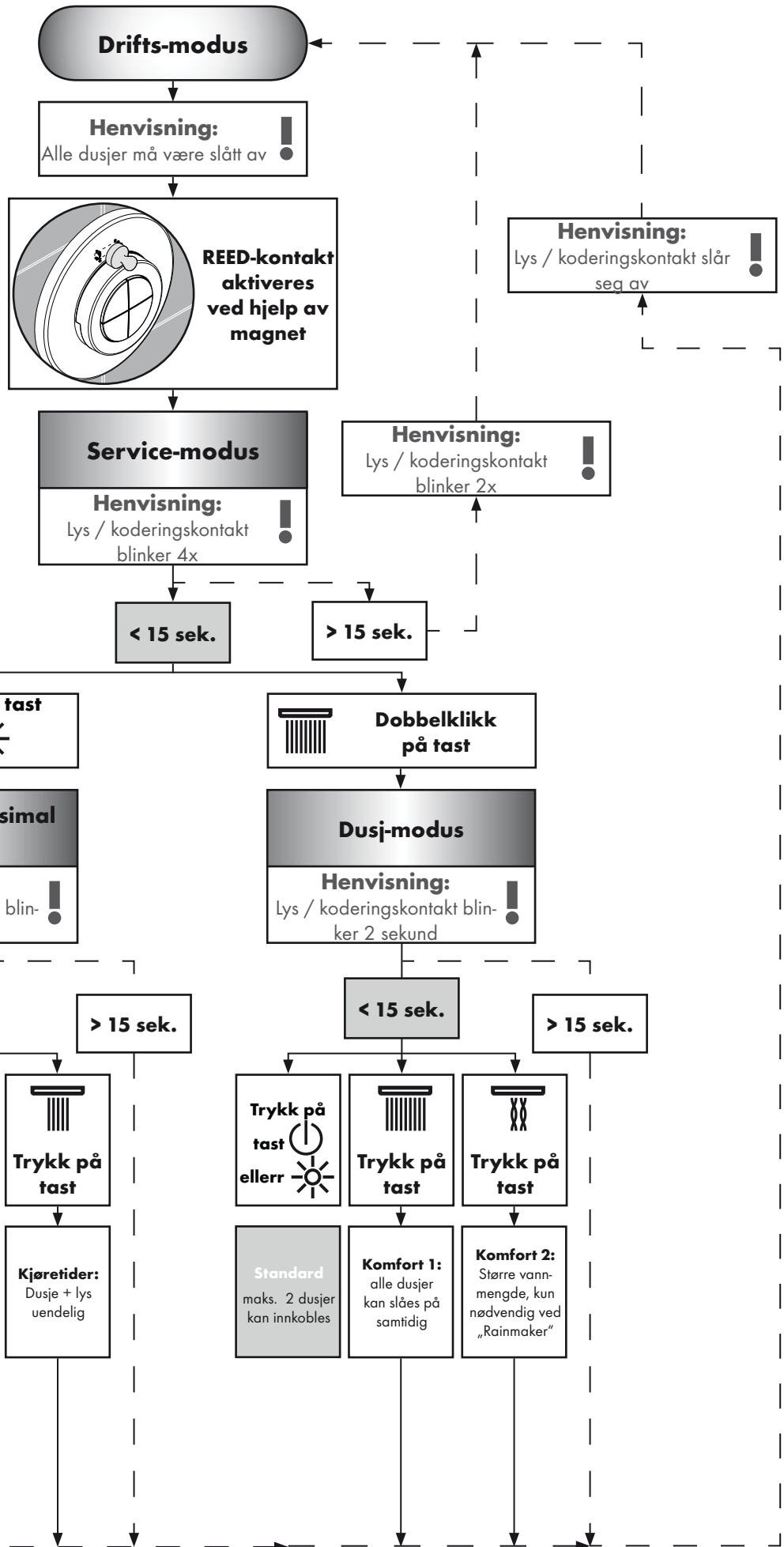
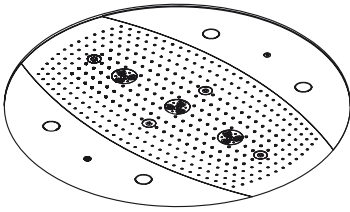

Norsk Ekspert-nivå

Raindance Rainfall
28411000

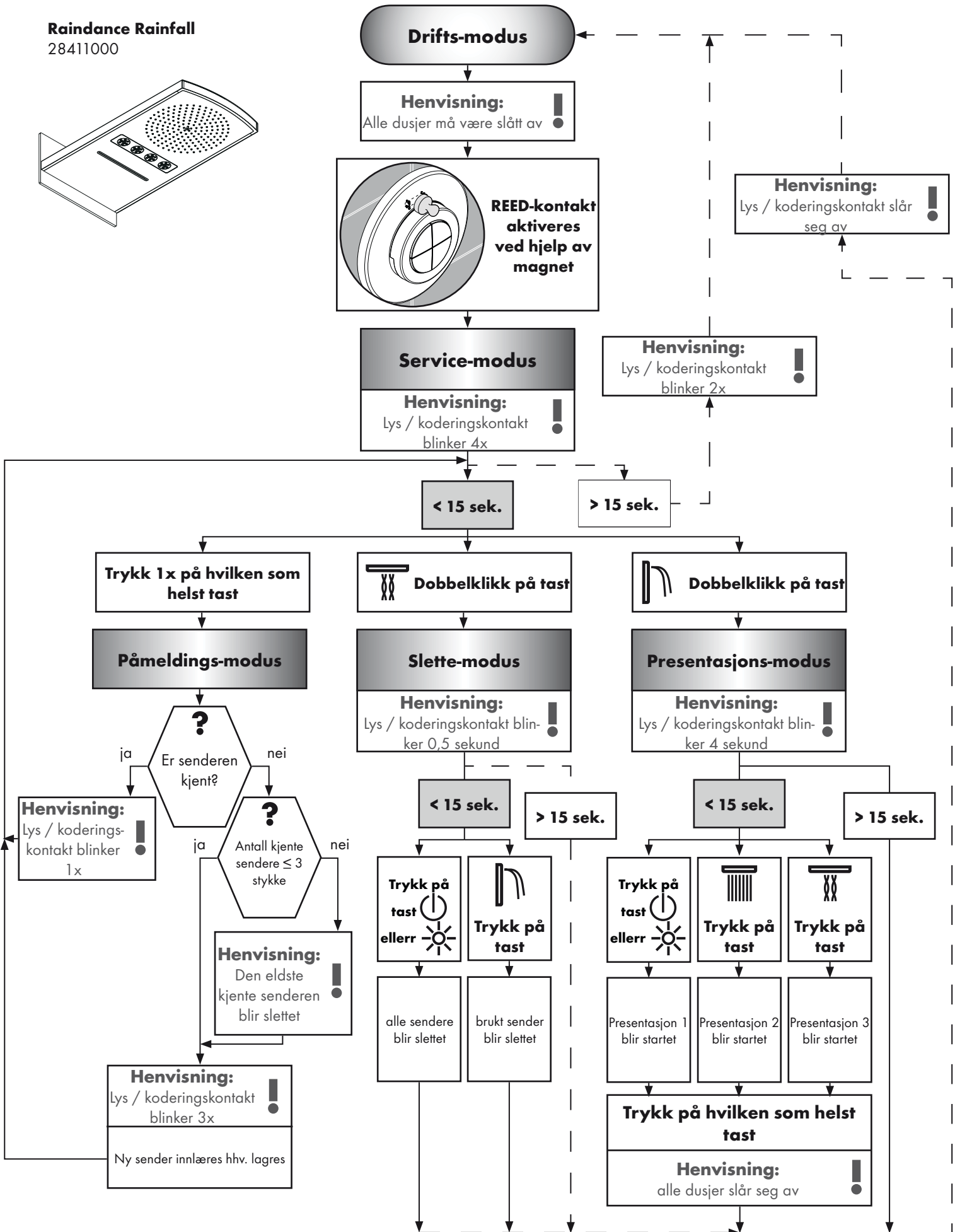
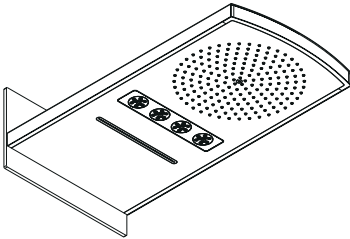

Norsk Ekspert-nivå

Raindance Rainmaker
28403000 / 28404000

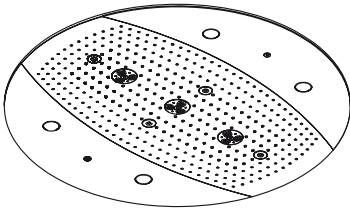

Drifts-modus

Henvisning:
Alle dusjer må være slått av



Service-modus
Henvisning:
Lys / koderingskontakt
blinker 4x

Henvisning:
Lys / koderingskontakt
blinker 2x

Henvisning:
Lys / koderingskontakt slår
seg av

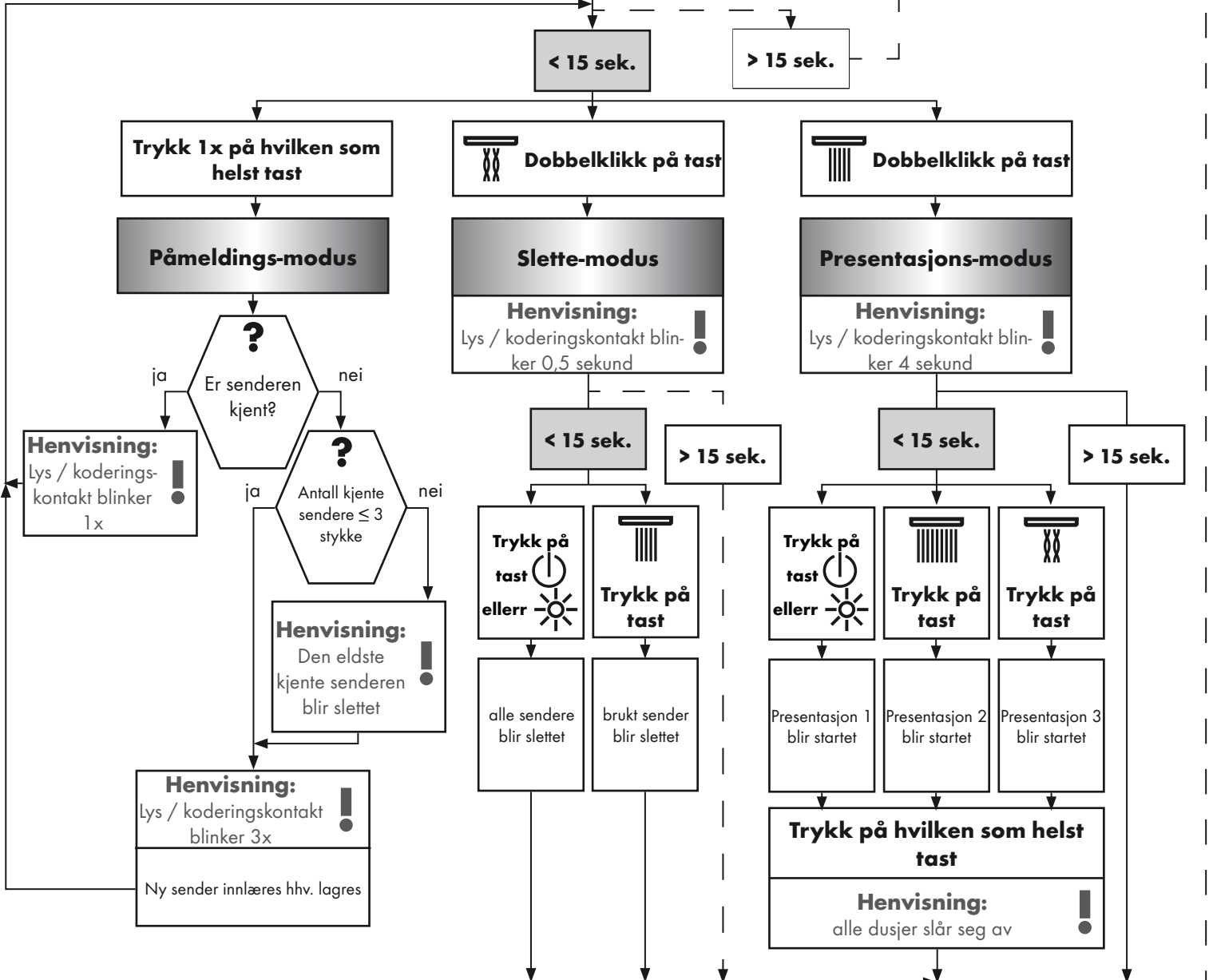

Норми и директиви:

Използването на продукта се гарантира от следните директиви:

- EN 15200
- EN 60335-2-105



Указания за безопасност:

- Позволено е използването на продукта само за къпане, хигиена и цели на почистване на тялото.
- Не е позволено деца да използват системата на душа без надзор.
- Не е позволено деца, както и възрастни с физически, умствени и / или сензорни ограничения да използват системата на душа без надзор. Не е позволено използването на системата на душа от лица, употребили алкохол или дрога.
- Трябва да се избягва контакта на струите на разпръсквателя с чувствителни части на тялото (напр. очите). Между разпръсквателя и тялото трябва да се спазва достатъчно разстояние.
- Големите разлики в налягането между изводите за студената и топлата вода трябва да се изравняват.



Свързване към електричеството:

- Дейностите по инсталацията и инспекцията следва да бъдат изпълнявани от оторизиран електротехник при спазване на VDE 0100 Част 701 и IEC 60364-7-701.
- За електрическото свързване се използва само един контакт. Захранването с ток се извършва с помощта на външен трансформатор.
- В непосредствена близост не бива да се намират лесно запалими материали.
- Околната температура не бива да бъде по-висока от 50 °C.
- Цялостното захранване с ток се извършва с извод за променлив ток 230V/N/PE/50Hz.
- Защитата трябва да се осъществи с предпазен шалтер за остатъчен ток (RCD/ FI) с параметриран диференциален ток ≤ 30 mA.
- Ако е необходимо изравняване на потенциала, това трябва да се извърши от страна на инвеститора.
- При електроинсталацията трябва да се спазват съответните разпоредби на VDE (Съюз на електротехниците в Германия), на страната и на EVU (Съюз на електроснабдителните предприятия) в съответно валидната им редакция.
- Трябва да се гарантира, че продуктът може да бъде отделен от мрежата. Или посредством свободно достъпен щекер или посредством прекъсвач на всички полюси по EN 60335-1 абз. 24.3.



Монтаж: (вижте стр. 303)

- Внимание! Арматурата трябва да се монтира, промие и провери в съответствие с валидните норми. (Инсталация по EN 1717)
Вижте ръководството за монтаж:
Raindance Rainfall 28411000
Raindance Rainmaker 28403000 / 28404000 / 28417000 / 28418000
- Извършването на всички дейности е позволено само в състояние без напрежение.
- Основното тяло 15941180 може да се монтира само отвесно! Монтаж с регулиращ пръстен (A) е възможен само в предната и средната област!
- Всички компоненти трябва да останат достъпни.

Технически данни:

Работно налягане::	макс. 1 МПа
Препоръчително работно налягане:	0,1 - 0,5 МПа
Контролно налягане::	1,6 МПа
(1 МПа = 10 bar = 147 PSI)	
Температура на горещата вода::	макс. 80° C
Препоръчителна температура на горещата вода:	65° C
Присъединителни размери:	G 3/4
Изводи свободен изходящ накрайник:	Смесена вода
Свободен поток при 0,3 МПа:	
1 Консуматор:	35 л/мин
2 Консуматор:	45 л/мин



Принадлежности: (вижте стр. 264)



Размери: (вижте стр. 292)



Примери за монтаж Raindance Rainfall: (вижте стр. 295)



Примери за монтаж Raindance Rainmaker: (вижте стр. 299)



Обслужване: (вижте стр. 266)

- Продуктът не е предвиден за употреба във връзка с парна баня!



Почистване Цедка за улавяне на замърсявания: (вижте стр. 309)

Резервни части (вижте стр. 311)

























Монтаж вижте стр. 303

БЪЛГАРСКИ

Техническа информация

Неизправност	Причина	Помощ
Без функция	<ul style="list-style-type: none"> - Липсва захранване с напрежение - Трансформатор основен набор дефектен - Приемникът е разположен неблагоприятно / дефектен - Предавателят не се запаметява / дефектен 	<ul style="list-style-type: none"> - Осигурете захранване с напрежение - Сменете трансформатора - Променете позицията на приемника респ. сменете приемника - Заучете / сменете предавателя
Режим конфигурация не може да се конфигурира	<ul style="list-style-type: none"> - Контакт Reed не е на подходяща позиция зад розетката - Контакт Reed неизправен 	<ul style="list-style-type: none"> - Разположете контакт Reed на розетката - Сменете свързващия кабел на магнитния клапан
Няма функция на светлина	<ul style="list-style-type: none"> - Трансформатор Rainmaker не е поставен / грешен - Захранвания светлинни релета грешни / дефектни 	<ul style="list-style-type: none"> - Осигурете захранване с напрежение на трансформатора / сменете трансформатора - Проверете / сменете връзките и светлинните релета
Консуматорите се изключват автоматично	<ul style="list-style-type: none"> - Времето за работа е заложено в режима на програмата 	<ul style="list-style-type: none"> - Удължете / изключете времето за работа по инерция в сервисния режим
Арматурата не е уплътнена	<ul style="list-style-type: none"> - Замърсен / дефектен магнитен клапан 	<ul style="list-style-type: none"> - Почистете / сменете мембраната на магнитния клапан
Твърде малък поток	<ul style="list-style-type: none"> - Цедката за улавяне на замърсявания на входящата страна е замърсена 	<ul style="list-style-type: none"> - Почистете / сменете цедката за улавяне на замърсяванията

Символи

	Извод за вода DN 20 Топла вода		Трансформатор		Изравняване на потенциала
	Извод за вода DN 20 Студена вода		Приемник		всичко изкл
	Включване на водата		Кодиращи щепсели		Светлина
	Изключване на водата		230V		Rain
	От • функцията е гарантирана.		12V		Whirl
	Мощността на изтичане трябва да бъде повече от 50 л/мин.		Тръба за полагане на кабели		Rainflow
	Отвеждане		Управление на светлините 27189000 (не е в обема на доставка)		Rain AIR XXL
	Среда на коритото на душ-кабината		Светлинно реле Rainmaker		Rain AIR
			Трансформатор Rainmaker		Силикон (без оцетна киселина!)
			Предварително инсталиран от страна на инвеститора извод 12 V за светлина (макс. 80 W)		

Монтаж вижте стр. 303

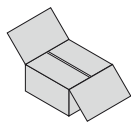

БЪЛГАРСКИ Принадлежности

Трансформатор:

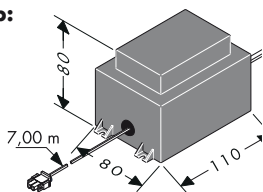

Мощността на външния трансформатор възлиза на 50 VA. Трансформаторът трябва да се инсталира в сухата област (защитна зона 3). Трансформаторът може да се монтира в пластмасов корпус с приемника, като се спази EN/IEC 60335-1. (размери припл. 250 x 160 x 92 mm, не спада към обема на доставка.) Доставеният кабел дава възможност за инсталация на трансформатора на разстояние до 7,00 m от приемника. За целта трябва да се предвиди тръба за полагане на кабели EN35 (не спада към обема на доставка). Тръбата за полагане на кабели трябва да се фиксира минимум на всеки 500 mm и радиусът на огъване трябва да бъде по-голям от 100.

Дългият припл. 7,00 m вторичен кабел на трансформатора не бива да бъде скъсяван. Излишната дължина на кабела би трябвало да се остави в близост до трансформатора. Не е позволена смяна на повредения свързващ кабел. Трансформаторът не бива да се използва повече.

Кабела за свързване към мрежата на този трансформатор не може да се сменя. При дефектен кабел за свързване към мрежата кабелът заедно с трансформатора трябва да бъдат сменени от електротехник.

Светлинно реле:

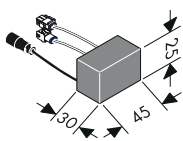

(само при варианти с интегрирана светлина)
Позволено е натоварване на светлинното реле с максимум 12 V AC / 80 W.
Не се допуска работа с мрежа от 230 V.

Управление на светлините:

27189000

(не се съдържа в обема на доставка)

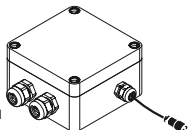

(iControl mobile 15944000)

Управлението на светлината трябва да бъде свързано при вариантите с външен източник на светлина. Управлението на светлината трябва да бъде достъпно по всяко време.

Кодиращи щепсели:

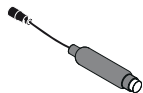

(Raindance Rainfall 28411000 /
Raindance Rainmaker 28403000)

Кодиращ щепсел трябва да се свърже при варианти без светлина.

Ако режимът на сервиз е активиран при вариантите без светлина, светодиодът на кодирания щепсел показва оптичните обратни сигнализираня.

Кодираният щекер трябва да бъде достъпен по всяко време.

Свързващ кабел Блок магнитни вентили / Свързващ кабел Светлина:



Дългият 7,50 m блокировъчен кабел на магнитния вентил както и дългият 10,00 m светлинен кабел не бива да бъдат скъсявани. Излишната дължина на кабела би трябвало да се остави в близост до приемника.

Блокировъчният кабел на магнитния вентил и светлинният кабел не бива да се полагат в доставения канал за полагане на кабели (EN 20).

Тръбата за полагане на кабели трябва да се фиксира минимум на всеки 500 mm и радиусът на огъване трябва да бъде по-голям от 100.

Внимание! В каналите за полагане на кабели за блокировъчния кабел на магнитния вентил и светлинния кабел не бива да се полагат електрически кабели с напрежение повече от 12V.

Монтаж вижте стр. 303

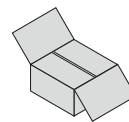

Приемник:

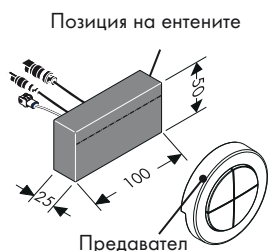

За предпочитане е приемникът да се монтира в същото помещение като устройството за душа.

Ако това не е възможно, приемникът може да се монтира и в помещение, граничещо с устройството за душа.

Приемникът не бива да се монтира в метален корпус, защото това ще екранира радиосигналите на предавателя. Освен това трябва да се обърне внимание на това, в близост до мястото на монтажа да се намират възможно

най-малко екраниращи метални части.

За оптималното разпознаване на радиосигналите антената на приемника по възможност трябва да се обърне към предавателя.

Предавател:



При доставката предавателят е вече заучен за приемника. Благодарение на идентичните серийни номера предавателят може да се причисли към приемника.

Допълнителните и в последствие придобити предаватели трябва да бъдат заучени. Могат да се заучат респ. запаметят максимум четири предавателя. (вижте стр. 270/271 Режим регистрация).

Радиочестотата на предавателя е 868,3 MHz.

Указание: Коректен метод за действие при смяна на дефектен предавател с нов.

1. Изтриване на всички предаватели (Режим регистрация ⇒ Режим на изтриване).
2. Всички предаватели, освен дефектния предавател, се заучават наново. (Сервизен режим ⇒ Режим регистрация).

Указание: Приемникът и предавателят имат обсег на действие от припл. 10,00 m. Обсегът на действие зависи от това, колко силни се заглушават радиосигналите между предавателя и приемника.

Указание: По причини на безопасността използвайте предавателя само в областта на видимост на системата на душа. В противен случай водата би могла да се включи по невнимание

Материал	Заглушаване
Дърво, гипс, стъкло (без покритие, без метал)	0 - 10 %
Тухли, плочи от прешпан	5 - 35 %
Бетон с желязна армировка	10 - 90 %
Метал, алуминиеви ламинати	90 - 100 %

Магнит:



За активиране на сервизния режим магнитът трябва да активира контакта REED (зад розетката). (вижте стр. 268/269, Сервизен режим).

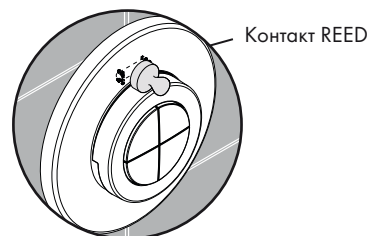

БЪЛГАРСКИ Обслужване

Raindance Rainfall

28411000

iControl mobile

15940180 / 15942000

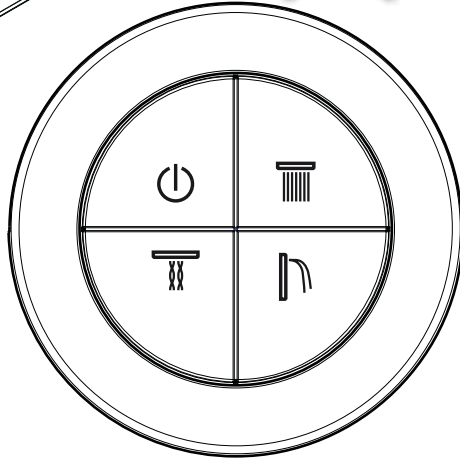
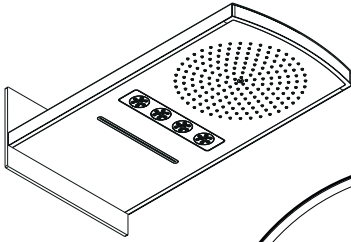

Raindance Rainfall

28411000

iControl mobile

15941180 / 15944000

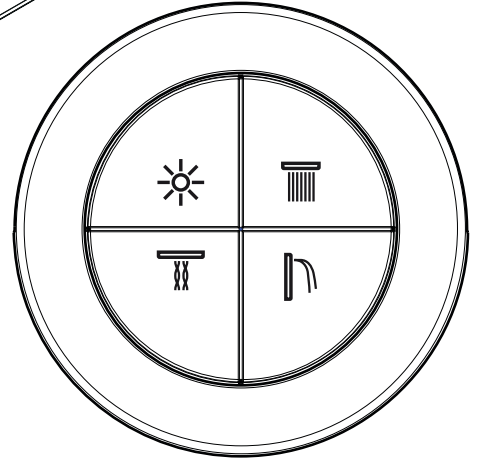
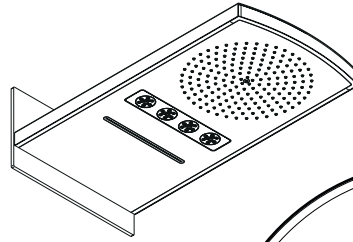

Raindance Rainmaker

28403000

iControl mobile

15940180 / 15943000

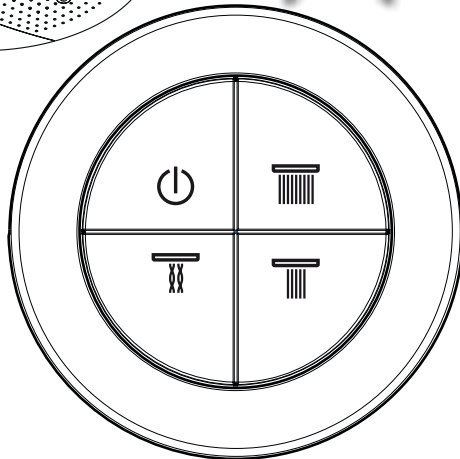
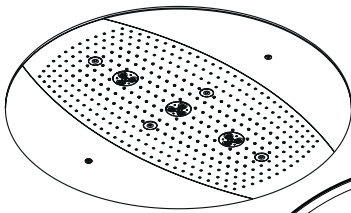

Raindance Rainmaker

28404000

iControl mobile

15941180 / 15945000

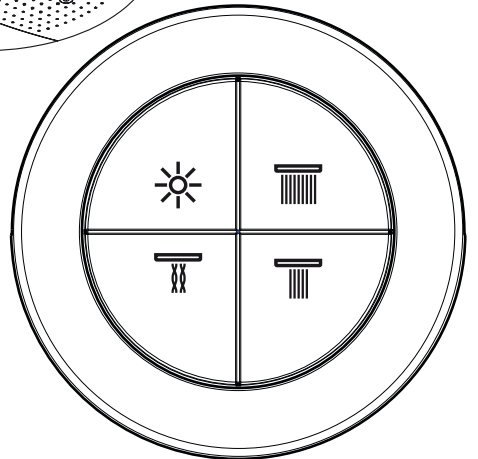
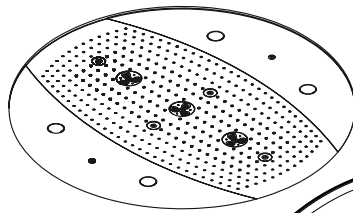

всичко изкл



Rain



Whirl



Rainflow



Светлина



Rain AIR XXL



Rain AIR

Монтаж вижте стр. 303

Включване и изключване на разпръсквателите и светлината:

(Стандартна функция със светлина)

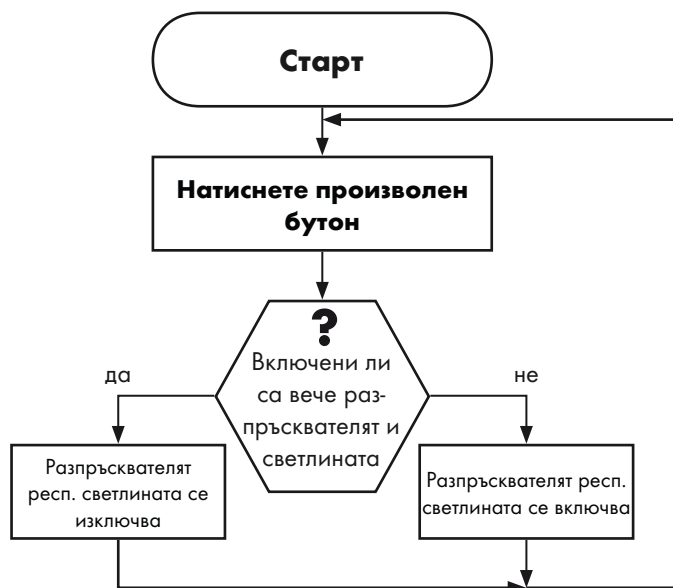

Включване и изключване на разпръсквателите:

(Стандартна функция без светлина)

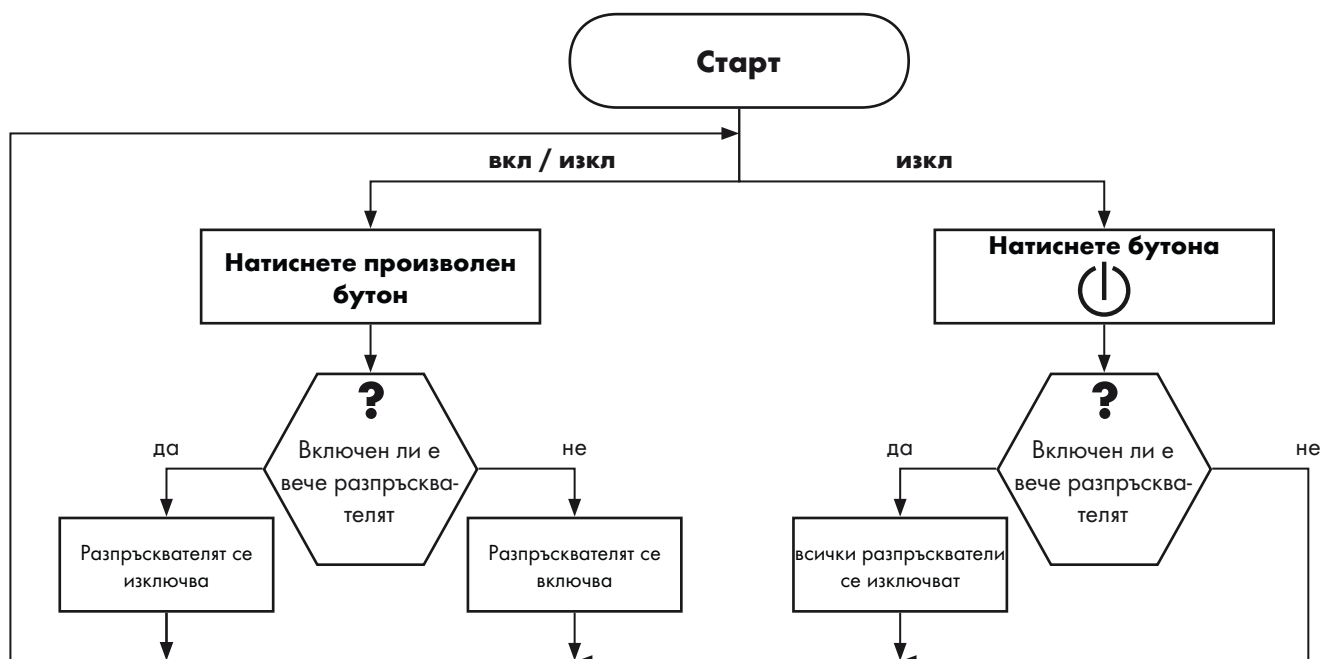

БЪЛГАРСКИ

Ниво обслужващ

Raindance Rainfall
28411000

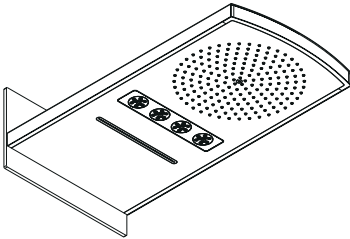

Режим на работа

Указание:
Всички разпръскватели
трябва да се изключат



Сервизен режим

Указание:
Светлинният / кодиращият
щепсел мига 4x

Указание:
Светлинният / кодиращият
щепсел се изключва

Указание:
Светлинният / кодиращият
щепсел мига 2x

< 15 sek

> 15 sek

**Кликнете два пъти на
бутон  или **

**Кликнете два пъти
на бутон **

**Режим максимален
срок на работа**

Указание:
Светлинният / кодиращият
щепсел мига в такт от 1sek

Режим разпръскватели

Указание:
Светлинният / кодиращият
щепсел мига в такт от 2sek

< 15 sek

> 15 sek

< 15 sek

> 15 sek

**Натиснете
бутон  или **

**Натиснете
бутона **

**Натиснете
бутона **

**Натиснете
бутона **

**Натиснете
бутон  или **

**Натиснете
бутона **

**Времена за
работа:**
Разпръсквате-
ли: 30 s
Светлина: 30
min

Стандарт:
**Времена за
работа:**
Разпръсквате-
ли: 60 s
Светлина: 30 min

**Времена за
работа:**
Разпръсквате-
ли: 180 s
Светлина: 30
min

**Времена за
работа:**
Разпръсквате-
ли + светлина:
безкрайно

Стандарт
могат да се
включат макс. 2
разпръсквателя

Комфорт 1:
могат да
се включат
едновременно
всички
разпръскватели

БЪЛГАРСКИ

Ниво обслужващ

Raindance Rainmaker
28403000 / 28404000

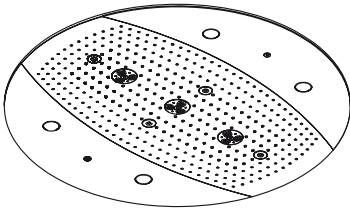

Режим на работа

Указание:
Всички разпръскватели
трябва да се изключат



Сервизен режим



Указание:
Светлинният / кодиращият
щепсел мига 4x

Указание:
Светлинният / кодиращият
щепсел мига 2x

Указание:
Светлинният / кодиращият
щепсел се изключва

< 15 sek

> 15 sek

**Кликнете два пъти на
бутон**  или 

**Кликнете два пъти
на бутон** 

**Режим максимален
срок на работа**

Указание:
Светлинният / кодиращият
щепсел мига в такт от 1sek

Режим разпръскватели

Указание:
Светлинният / кодиращият
щепсел мига в такт от 2sek

< 15 sek

> 15 sek

< 15 sek

> 15 sek

**Натиснете
бутон**  или 

**Натиснете
бутона** 

**Натиснете
бутона** 

**Натиснете
бутона** 

**Натиснете
бутон**  или 

**Натиснете
бутона** 

**Натиснете
бутона** 

**Времена за
работа:**
Разпръсквате-
ли: 30 s
Светлина: 30
min

Стандарт:
**Времена за
работа:**
Разпръскватели:
60 s
Светлина: 30 min

**Времена за
работа:**
Разпръсквате-
ли: 180 s
Светлина: 30
min

**Времена за
работа:**
Разпръскватели
+ светлина:
безкрайно

Стандарт
могат да се
включат макс. 2
разпръсквателя

Комфорт 1:
могат да
се включат
едновременно
всички
разпръскватели

Комфорт 2:
По-голямо
количество
вода, възможно
само при
Rainmakeri

БЪЛГАРСКИ

Ниво експерт

Raindance Rainmaker
28403000 / 28404000

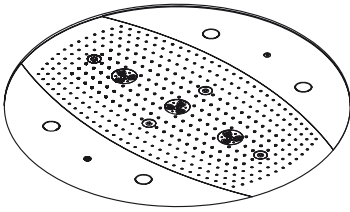

Режим на работа

Указание:
Всички разпръскватели трябва да се изключат



Сервизен режим

Указание:
Светлинният / кодиращият щепсел мига 4x

Указание:
Светлинният / кодиращият щепсел мига 2x

Указание:
Светлинният / кодиращият щепсел се изключва

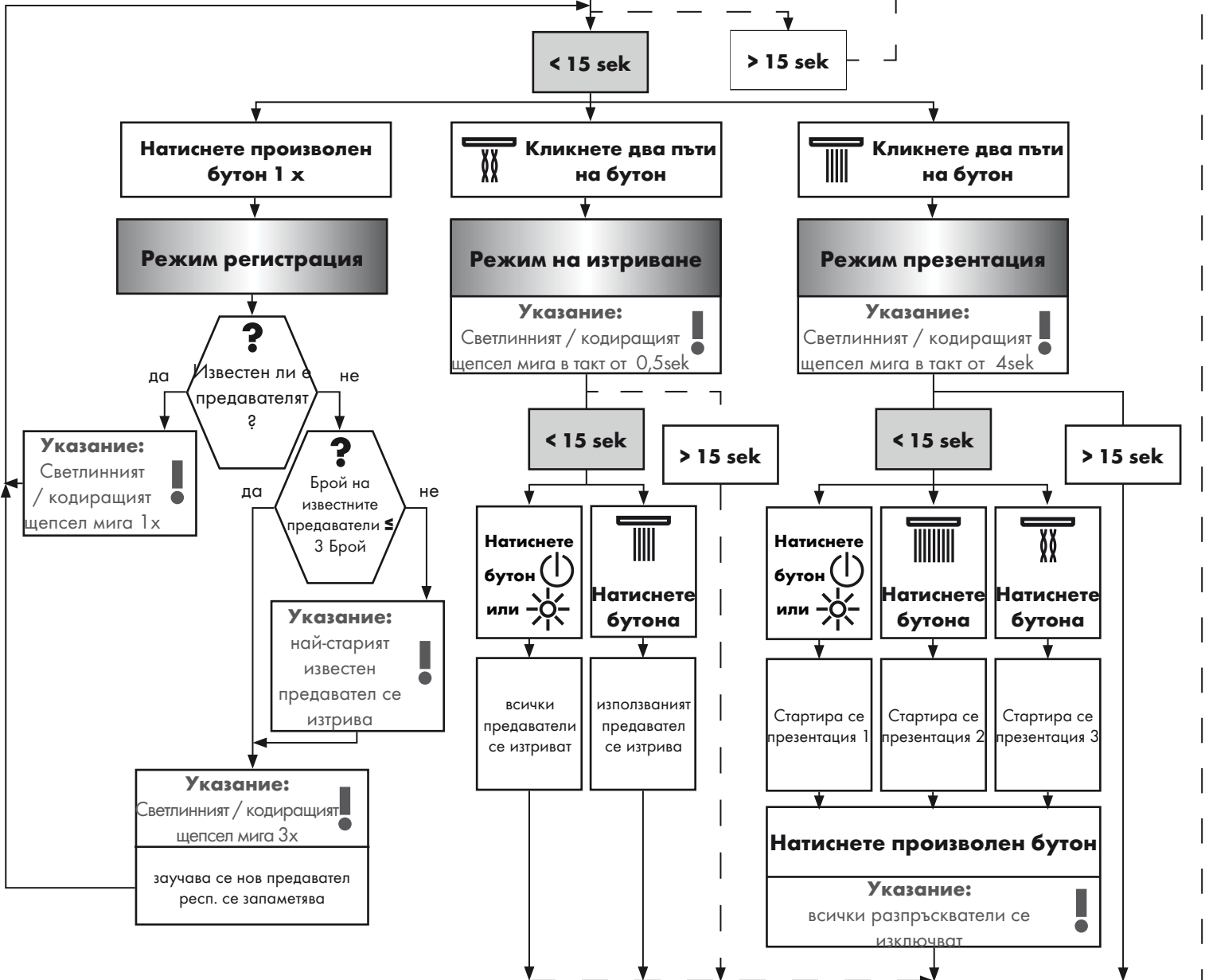

БЪЛГАРСКИ

Ниво експерт

Raindance Rainmaker
28403000 / 28404000

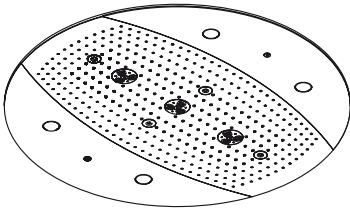

Режим на работа

Указание:
Всички разпръскватели трябва да се изключат



Сервизен режим

Указание:
Светлинният / кодиращият щепсел мига 4x

Указание:
Светлинният / кодиращият щепсел мига 2x

Указание:
Светлинният / кодиращият щепсел се изключва

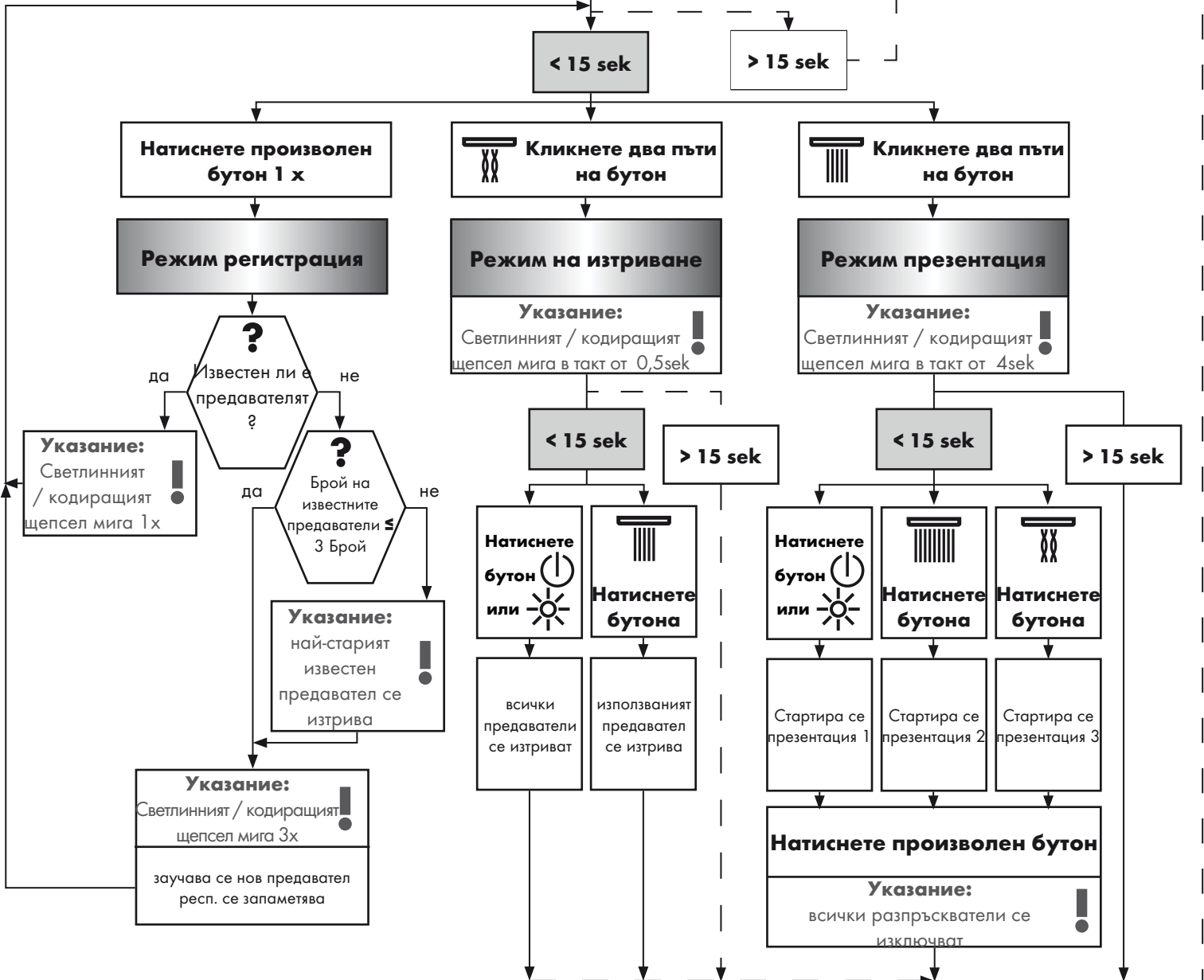

Përdorimi i pajisjes garantohej nëpërmjet direktivave të mëposhtme:

- EN 15200
- EN 60335-2-105



Udhëzime sigurie:

- Produkti duhet të përdoret vetëm qëllimet e banjave, të higjienës dhe të larjes së trupit.
- Nuk lejohet përdorimi pa mbikëqyrje i sistemit të dushit nga fëmijët.
- Fëmijët dhe të rriturit me aftësi të kufizuara fizike, mendore dhe/ose ndijuese nuk duhet ta përdorin sistemin e dushit pa qenë nën mbikëqyrje. Personat që janë nën ndikimin e drogave ose të alkoolit nuk duhet ta përdorin sistemin e dushit.
- Kontakti i valëve të dushit me pjesët e ndjeshme të trupit (p.sh. me sytë) duhet që të shmanget. Midis dushit dhe trupit duhet që të mbahet një distancë e mjaftueshme.
- Ndryshimet e mëdha të presionit mes lidhjeve të ujit të ftohtë dhe atij të ngrohtë duhen ekuilibruar.



Lidhja me rrjetin elektrik:

- Punimet e instalimit dhe të kontrollit duhet të realizohen nga një elektrikist i autorizuar duke marrë parasysh VDE 0100 Pjesa 701 dhe standardin IEC 60364-7-701.
- Për lidhjen elektrike nevojitet vetëm një prizë. Ushqimi me energji elektrike realizohet nëpërmjet një transformatori të jashtëm.
- Në afërsi nuk duhet të ndodhen materiale që ndizen lehtë.
- Temperatura e ambientit nuk duhet të jetë më e lartë se 50 °C.
- I gjithë ushqimi me energji elektrike realizohet përmes një lidhjeje me rrymë alternative 230V/N/PE/50Hz.
- Sigurimi duhet të kryhet nëpërmjet një pajisjeje mbrojtëse kundër rrjedhjes së rrymës (RCD/ FI) me një vlerësim të rrymës diferenciale ≤ 30mA.
- Nëse është i nevojshëm barazimi i potencialit, atëherë ai duhet bërë gjatë ndërtimit.
- Gjatë instalimit elektrik duhen respektuar normat përkatëse të VDE-së, të shtetit dhe të EVU-së në verzionin e tyre aktual
- Duhet të garantohej që pajisja të mund të shkëputet nga rrjeti elektrik. Kjo mund të bëhet ose nëpërmjet një spine lehtësisht të arritshme, ose nëpërmjet një çelësi me të gjitha polet, sipas standardit EN 60335-1, paragrafi 24.3.



Montimi: (shih faqen 303)

- Kujdes! Armatura duhet montuar, shpërlarë dhe kontrolluar në bazë të normave të vlefshme. (Instalimi sipas normave EN 1717) Shikoni "Udhëzuesin e montimit": Raindance Rainfall 28411000 Raindance Rainmaker 28403000 / 28404000 / 28417000 / 28418000
- Të gjitha punët duhet të bëhen vetëm në një gjendje pa ushqim me tension.
- Skeleti 15941180 mund të montohet vetëm vertikalisht! Montimi me unazë përshtatëse (A) është i mundur vetëm në zonën e përparme dhe të mesme!
- Të gjithë komponentët duhet të jenë të arritshëm.

Të dhëna teknike:

Presioni gjatë punës:	maks. 1 MPa
Presioni i rekomanduar:	0,1 - 0,5 MPa
Presioni për provë:	1,6 MPa
(1 MPa = 10 bar = 147 PSI)	
Temperatura e ujit të ngrohtë:	maks. 80 ° C
Temperatura e rekomanduar e ujit të ngrohtë:	65 ° C
Përmasat e lidhjeve:	G ¾
Lidhjet dalja e lirë:	Ujë i përzier
Rrjedhja e lirë me 0,3 Mpa:	
1 Konsumator:	35 l/min
2 Konsumator:	45 l/min



Pajisje shtesë: (shih faqen 274)



Përmasat: (shih faqen 292)



Shembuj të montimit Raindance Rainfall: (shih faqen 295)



Shembuj të montimit Raindance Rainmaker: (shih faqen 299)



Përdorimi: (shih faqen 276)

- Në rast të një shkëputjeje të tensionit të rrjetit 230V, pajisja e dushit nuk mund të përdoret.
- Pajisja nuk është parashikuar për përdorim në lidhje me një banjë me avull!





























Pastrimi Sitë për mbledhjen e papastërtive: (shih faqen 309)

Pjesët e këmbimit (shih faqen 311)

Shqib Informata teknike

Dentim	Shkaku	Ndihme
Asnjë funksion	<ul style="list-style-type: none"> - Nuk ka furnizim me energji - Transformatori nga njësia e montimit është me defekt - Marrësi i vendosur në vend të papërshtatshëm/ me defekt - Dërguesi i papërshtatur/me defekt 	<ul style="list-style-type: none"> - Siguroni furnizimin me energji - Ndërroni transformatorin - Ndryshoni pozicionin e marrësit ose ndërroni marrësin - Përshtatni/ndërroni dërguesin
Mënyra e funksionimit nuk mund të konfigurohet	<ul style="list-style-type: none"> - Kontakti Reed nuk është në pozicionin e duhur poshtë rozetës - Kontakti Reed është i dëmtuar 	<ul style="list-style-type: none"> - Vendosni kontaktin Reed në rozetë - Ndërroni kabllon e lidhjes së valvulës me magnet
Asnjë funksion i dritës	<ul style="list-style-type: none"> - Transformatori i Rainmaker nuk është vendosur në prizë/i dëmtuar - Kabllot e relesë së dritës të dëmtuara/me defekt 	<ul style="list-style-type: none"> - Siguroni furnizimin me energji të transformatorit/ndërroni transformatorin - Kontrolloni/ndërroni lidhjet dhe relenë e dritës
Përdoruesit ndërpriten në mënyrë të pavarur	<ul style="list-style-type: none"> - Është vendosur koha e përdorimit në mënyrën e programimit 	<ul style="list-style-type: none"> - Zgjatni/çaktivizoni kohën në mënyrën e shërbimit
Rubineti rrjedh ujë	<ul style="list-style-type: none"> - Valvula me magnet e bllokuar/me defekt 	<ul style="list-style-type: none"> - Pastroni/ndërroni membranën e valvulës me magnet
Qarkullimi i ujit është i dobët	<ul style="list-style-type: none"> - Filtri i bllokimit të papastërtive është i bllokuar në anën e hyrjes 	<ul style="list-style-type: none"> - Pastroni / këmbeni sitën

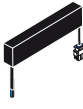
Simbole

	Lidhja me rrjetin e ujit DN 20 Uji i ngrohtë		Trafo		Barazimi i potencialeve
	Lidhja me rrjetin e ujit DN 20 Uji i ftohtë		Marrësi		të gjitha mbyllur
	Hapni ujin		Spina me kodim		Drita
	Mbyllni ujin.		230V		Rain
	Nga • është i mundur funksioni.		12V		Whirl
	Kapaciteti i shkarkimit duhet të jetë më shumë se 50 l/minutë.		Tubi i shtrimit		Rainflow
	Shkarkimi		Komandimi i dritës 27189000 (nuk përfshihet në vëllimin e furnizimit!)		Rain AIR XXL
	Mesi i vaskës së dushit		Releja e dritës Rainmaker		Rain AIR
			Trafo Rainmaker		Silikon (pa acid uthulle!)
			Lidhje 12 V e instaluar më parë për dritën (maks. 80 W)		

Montimi shih faqen 303

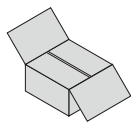

Shqib Pajisje shtesë

Trafo:

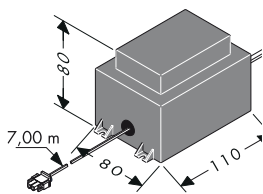

Fuqia e transformatorit të jashtëm është rreth 50 VA. Trafoja duhet të instalohet në një zonë pa lagështirë (zona e sigurisë 3) Transformatori mund të instalohet në një kuti plastike së bashku me marrësin, duke marrë parasysh standardin EN/IEC 60335-1. (përmasat rreth 250 x 160 x 92mm, nuk përfshihet në paketën që dërgohet me pajisjen.) Kabloja që ofrohet mundëson instalimin e transformatorit deri në 7,00 m larg nga marrësi. Për këtë duhet parashikuar një tub shtrimi EN35 (nuk përfshihet në paketën që dërgohet me pajisjen). Tubi i shtrimit duhet të jetë i fiksuar të paktën çdo 500mm dhe rrezja e harkimit duhet të jetë më e madhe se 100mm. Nuk lejohet që të shkurtrohet kabloja tjetër e trans-

formatorit, rreth 7,00 m e gjatë. Pjesa tjetër e kablos që nuk përdoret duhet që të mblihdet në afërsi të transformatorit. Një kablo bashkimi i dëmtuar nuk duhet të zëvendësohet. Në një rast të tillë, transformatori nuk mund të përdoret më. Kablo për lidhjen me rrjetin e rymës e këtij transformatori nuk mund të zëvendësohet. Në rast defekti të kablos së lidhjes me rrjetin elektrik, kabloja së bashku me transformatorin duhet të ndërrohet nga një elektroteknik.

Releja e dritës:

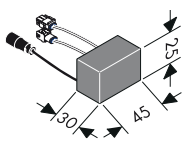

(vetëm në variantet me dritë të integruar)
Releja e dritës duhet të ushqehet maksimumi me 12V AC / 80W.
Nuk lejohet përdorimi në rrjetin 230V.

Komandimi i dritës:

27189000

(nuk përfshihet në vëllimin e furnizimit)

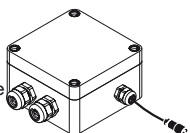

(iControl mobile 15944000)
Komandimi i dritës duhet që të lidhet në variantet me burim drite të jashtëm. Komandimi i dritës duhet të jetë i arritshëm në çdo moment.

Spina me kodim:

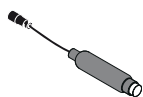

(Raindance Rainfall 28411000 / Raindance Rainmaker 28403000)
Spina me kodim duhet të lidhet në variantet pa dritë.
Kur në variantet pa ndriçim aktivizohet mënyra e shërbimit, dioda treguese e spinës me kodim tregon reagimin optik.
Spina me kodim duhet të jetë gjithmonë e arritshme.

Kabloja e lidhjes Blloku i valvulave elektromagnetike / Kabloja e lidhjes Drita:



Nuk lejohet shkurtimi i kablos së bllokut të valvulave elektromagnetike, 7,50 m i gjatë, si dhe i kablos së ndriçimit, 10,00 m i gjatë. Pjesa tjetër e kablos që nuk përdoret duhet që të mblihdet në afërsi të marrësit.

Kabloja e bllokut të valvulave elektromagnetike dhe kabloja e ndriçimit duhet të shtrohen vetëm në tubin e shtrimit (EN20) që dërgohet me pajisjen. Tubi i shtrimit duhet të jetë i fiksuar të paktën çdo 500mm dhe rrezja e harkimit duhet të jetë më e madhe se 100mm.

Kujdes: Në tubat e shtrimit për kabllon e bllokut të valvulave elektromagnetike dhe të ndriçimit nuk duhet të shtrohen kablo elektrike që përcjellin tension më të madh se 12V.

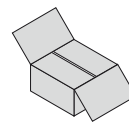

Marrësi:

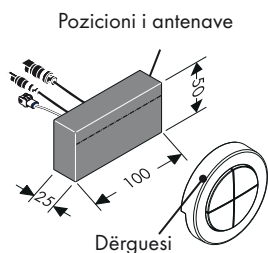

Preferohet që marrësi të montohet në të njëjtën hapësirë ku montohet dhe pajisja e dushit.

Kur kjo nuk është e mundur, marrësi mund të montohet gjithashtu në një hapësirë që ndodhet afër me pajisjen e dushit.

Nuk lejohet që marrësi të instalohet në një kuti metalike, sepse përndryshe sinjalet radio të dërguesit do të izoloohen. Përveç kësaj duhet mbajtur parasysh që në afërsi të vendit të montimit të marrësit duhet të ketë mundësisht sa më pak pjesë metalike.

Për një zbulim optimal të radiosinjaleve duhet që antena e marrësit mundësisht të jetë e drejtuar nga dërguesi.

Dërguesi:



Kur dërgohet pajisja, dërguesi është i përshtatur me marrësin. Dërguesi mund të përputhet me marrësin nëpërmjet numrave serialë identikë.

Dërguesit shtesë ose ata që blihen më pas duhet që të përshtaten. Mund të përshtaten ose mund të ruhen maksimumi katër dërgues. (shih faqen 280/281 Mënyra e njoftimit).

Radiofrekuenca e dërguesit është 868,3 MHz.

Udhëzim: Marrësi dhe dërguesi kanë një rreze veprimi prej rreth 10,00 metrash. Rrezja e veprimit varet nga fakti se sa shumë humbet radiosinjali midis dërguesit dhe marrësit.

Udhëzim: Për arsye sigurie përdoreni dërguesin vetëm në zonën e pamjes së sistemit të dushit. Përndryshe uji mund të hapet gabimisht.

Udhëzim: Procedura e saktë gjatë ndërrimit të një dërguesi të prishur me një dërgues të ri:

1. Fshini të gjithë dërguesit. (Mënyra e njoftimit ⇒ Mënyra e fshirjes).
2. Përshtatni nga e para të gjithë dërguesit me përjashtim të dërguesit me defekt. (Mënyra e shërbimit ⇒ Mënyra e njoftimit).

Materiali	Humbja e sinjalit
Dru, gips, xham (i/e paveshur, pa metal)	0 - 10 %
Tullë, pllaka fibre	5 - 35 %
Beton me përforcim me hekur	10 - 90 %
Metal, veshje me alumini	90 - 100 %

Magneti:



Për aktivizimin e mënyrës së shërbimit duhet që magneti të aktivizojë kontaktin REED (prapa rozetës). (shih faqen 278/279 Mënyra e shërbimit).

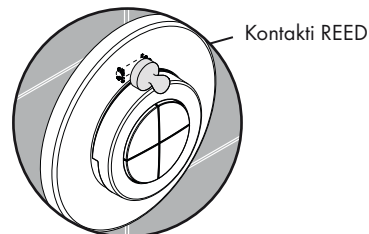

Shqib Përdorimi

Raindance Rainfall

28411000

iControl mobile

15940180 / 15942000

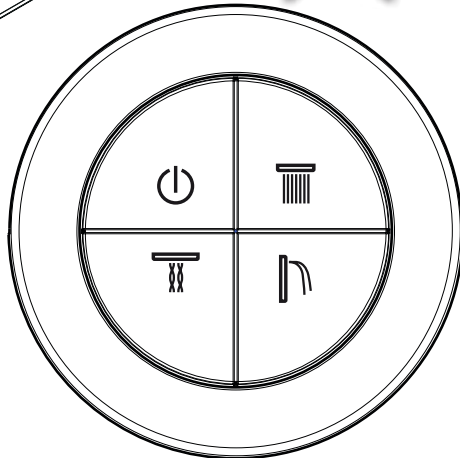
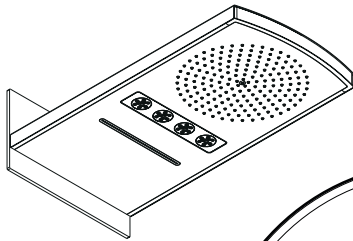

Raindance Rainfall

28411000

iControl mobile

15941180 / 15944000

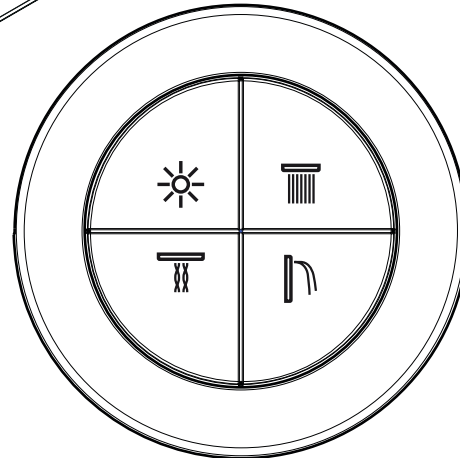
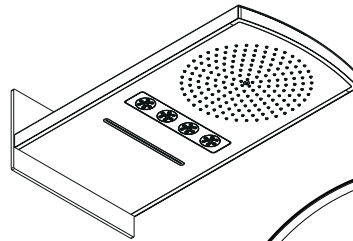

Raindance Rainmaker

28403000

iControl mobile

15940180 / 15943000

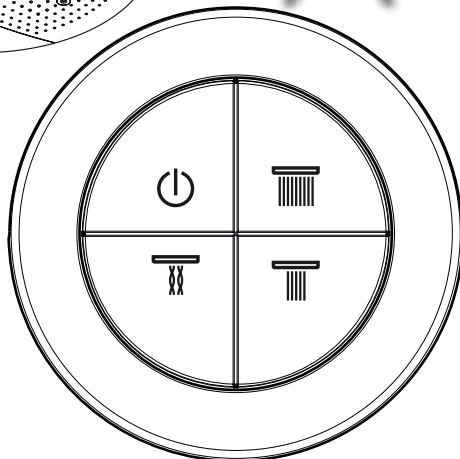
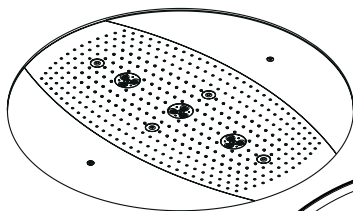

Raindance Rainmaker

28404000

iControl mobile

15941180 / 15945000

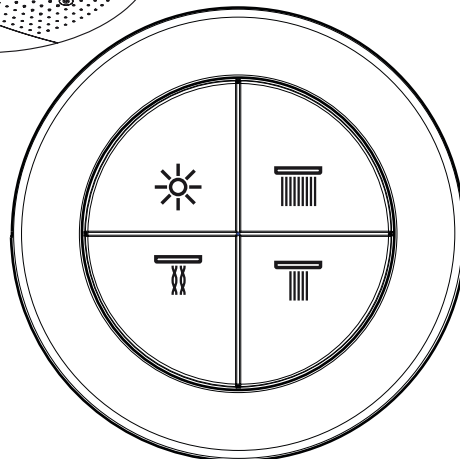
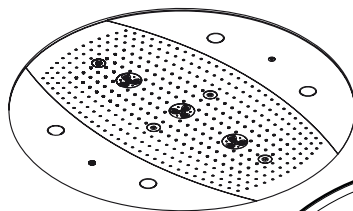

të gjitha mbyllur



Rain



Whirl



Rainflow



Drita



Rain AIR XXL



Rain AIR

Montimi shih faqen 303

Hapja dhe mbyllja e dusheve dhe dritës:

(Funksioni standard me dritë)

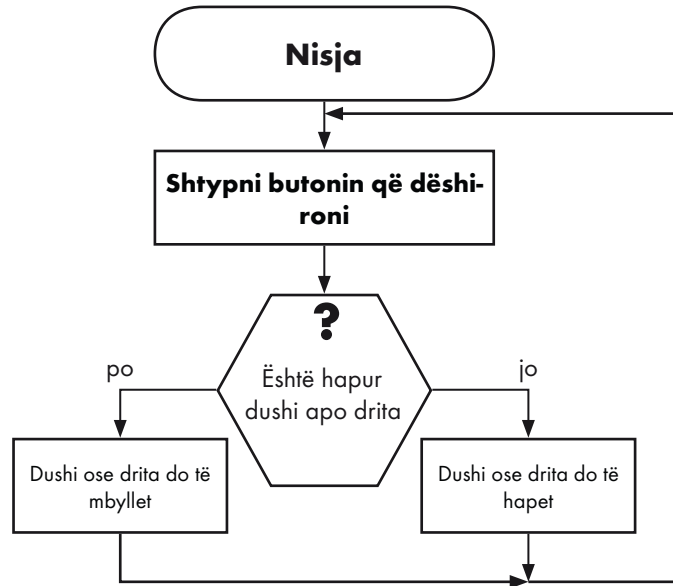

Hapja dhe mbyllja e dusheve:

(Funksioni standard pa dritë)

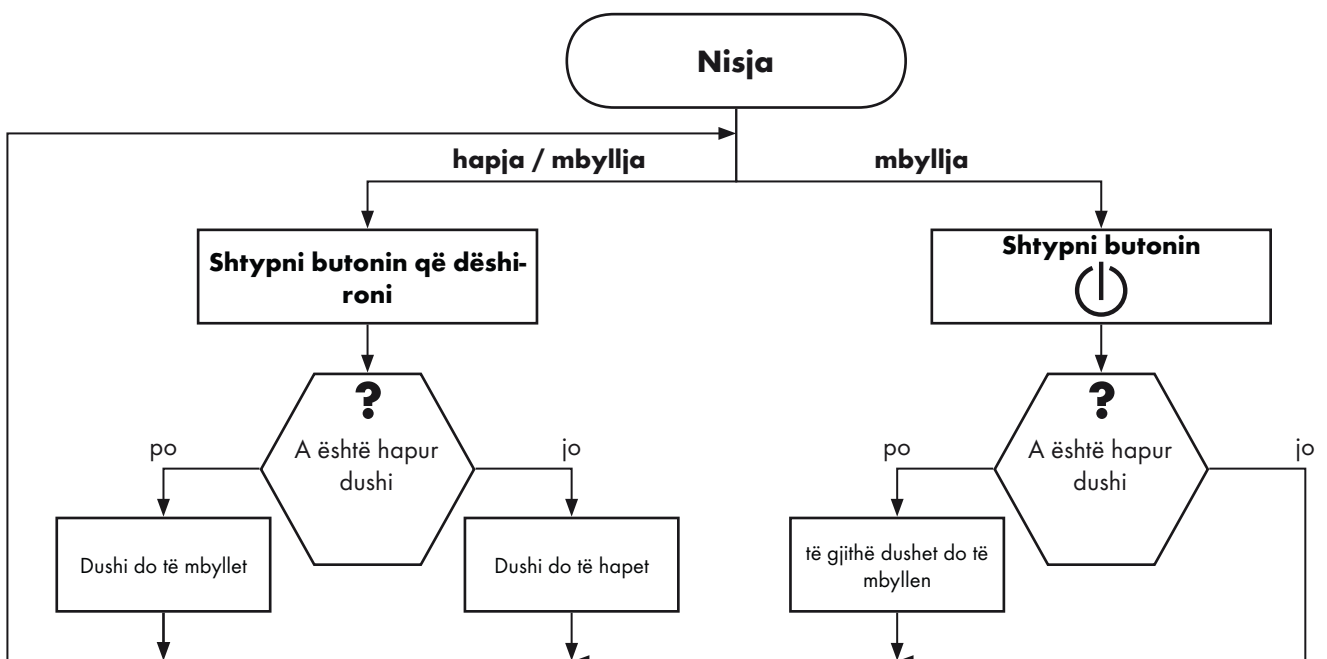

Shqib Kategoria e përdoruesit

Raindance Rainfall
28411000

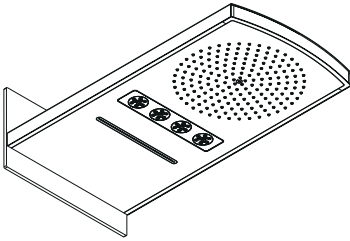

Mënyra e funksionimit

Udhëzim:
Të gjithë dushet duhet të jenë të mbyllur



Udhëzim:
Drita / spina me kodim fiket

Mënyra e shërbimit

Udhëzim:
Drita / spina me kodim vezullon 4 herë

Udhëzim:
Drita / spina me kodim vezullon 2 herë

< 15 sek.

> 15 sek.

Klikoni dy herë butonin
⏻ ose ☀️

Klikoni dy herë butonin
🚿

Mënyra e kohës maksimale të funksionimit
Udhëzim:
Drita / spina me kodim vezullon me sekuenca prej 1 sek.

Mënyra e dusheve
Udhëzim:
Drita / spina me kodim vezullon me sekuenca prej 2 sek.

< 15 sek.

> 15 sek.

< 15 sek.

> 15 sek.

Shtypni butonin ⏻ ose ☀️	Shtypni butonin 🚿	Shtypni butonin 🚿	Shtypni butonin 🚿
---------------------------------	--------------------------	--------------------------	--------------------------

Shtypni butonin ⏻ ose ☀️	Shtypni butonin 🚿
---------------------------------	--------------------------

Kohët e funksionimit: Dushet: 30 s Drita: 30 min	Standard: Kohët e funksionimit: Dushet: 60 s Drita: 30 min	Kohët e funksionimit: Dushet: 180 s Drita: 30 min	Kohët e funksionimit: Dushi + drita: pa kufizim
---	---	--	---

Standard mund të hapen maksimumi 2 dushe	Komfort 1: mund të hapen njëkohësisht të gjithë dushet
--	--

Shqib Kategoria e përdoruesit

Raindance Rainmaker
28403000 / 28404000

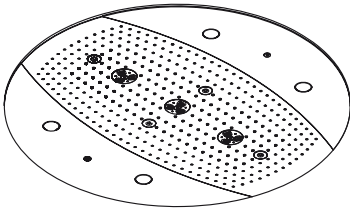

Mënyra e funksionimit

Udhëzim:
Të gjithë dushet duhet të jenë të mbyllur



Mënyra e shërbimit

Udhëzim:
Drita / spina me kodim vezullon 4 herë

Udhëzim:
Drita / spina me kodim fiket

Udhëzim:
Drita / spina me kodim vezullon 2 herë

< 15 sek.

> 15 sek.

Klikoni dy herë butonin
⏻ ose ☀️

Klikoni dy herë butonin
☔

Mënyra e kohës maksimale të funksionimit
Udhëzim:
Drita / spina me kodim vezullon me sekuenca prej 1 sek.

Mënyra e dusheve
Udhëzim:
Drita / spina me kodim vezullon me sekuenca prej 2 sek.

< 15 sek.

> 15 sek.

< 15 sek.

> 15 sek.

Shtypni butonin ⏻ ose ☀️	Shtypni butonin ☔	Shtypni butonin ☔	Shtypni butonin ☔
--------------------------	-------------------	-------------------	-------------------

Shtypni butonin ⏻ ose ☀️	Shtypni butonin ☔	Shtypni butonin ☔
--------------------------	-------------------	-------------------

Kohët e funksionimit: Dushet: 30 s Drita: 30 min	Standard: Kohët e funksionimit: Dushet: 60 s Drita: 30 min	Kohët e funksionimit:: Dushet: 180 s Drita: 30 min	Kohët e funksionimit: Dushi + drita: pa kufizim
---	---	---	---

Standard mund të hapen maksimumi 2 dushe	Komfort 1: mund të hapen njëkohësisht të gjithë dushet	Komfort 2: Sasi uji më të mëdha, të nevojshme vetëm të Rainmaker-i
--	--	--

Shqib Kategoria e ekspertëve

Raindance Rainfall
28411000

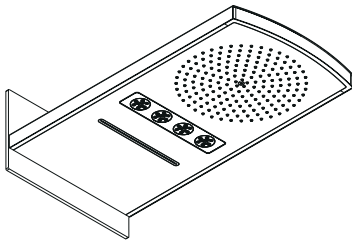

Mënyra e funksionimit

Udhëzim:
Të gjithë dushet duhet të jenë të mbyllur



Mënyra e shërbimit

Udhëzim:
Drita / spina me kodim vezullon 4 herë

Udhëzim:
Drita / spina me kodim fiket

Udhëzim:
Drita / spina me kodim vezullon 2 herë

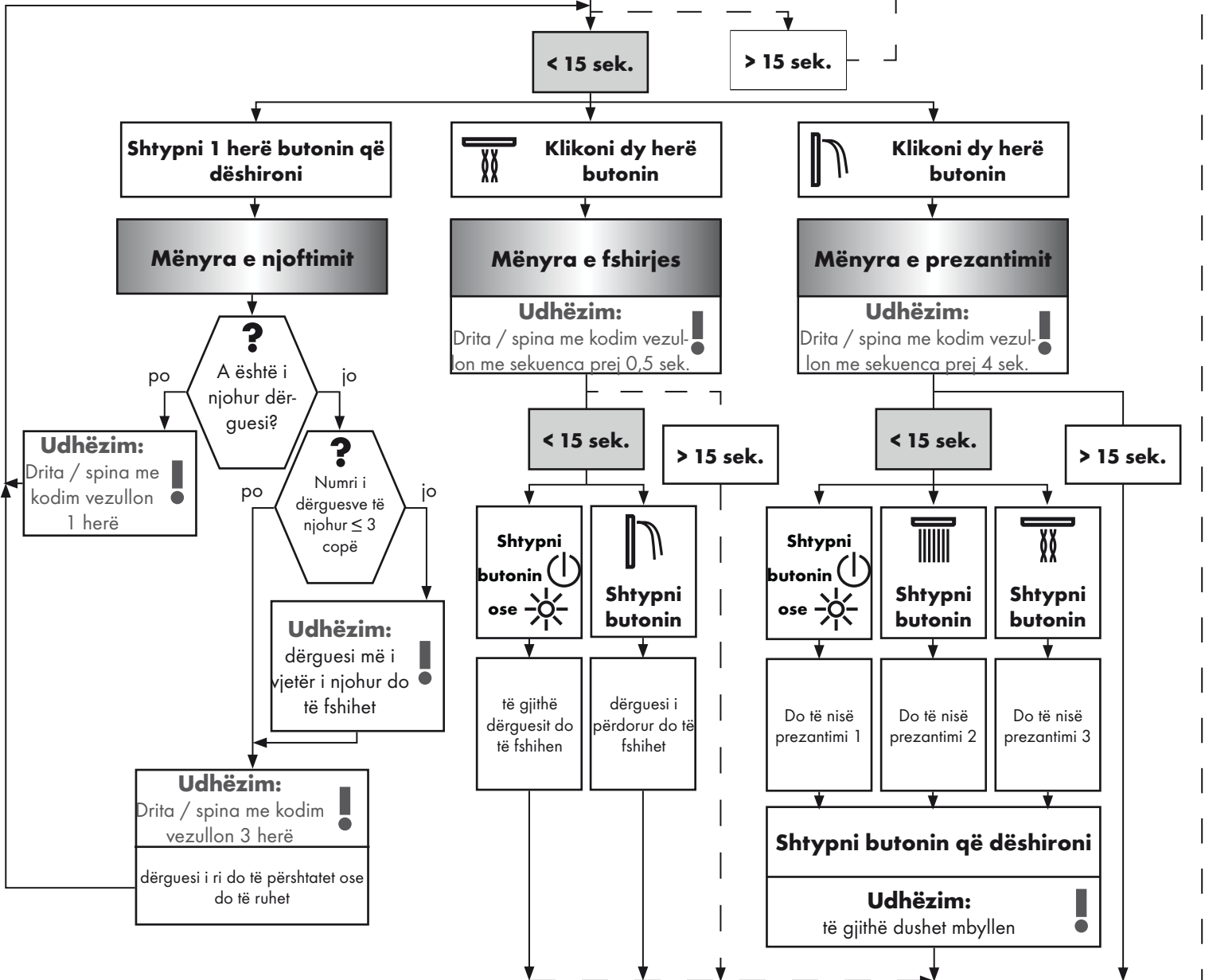

Shqib Kategoria e ekspertëve

Raindance Rainmaker
28403000 / 28404000

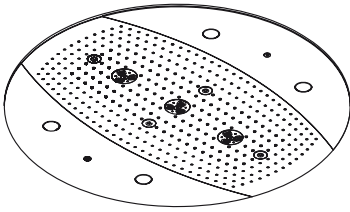

Mënyra e funksionimit

Udhëzim:
Të gjithë dushet duhet të jenë të mbyllur



Mënyra e shërbimit

Udhëzim:
Drita / spina me kodim vezullon 4 herë

Udhëzim:
Drita / spina me kodim fiket

Udhëzim:
Drita / spina me kodim vezullon 2 herë

< 15 sek.

> 15 sek.

Shtypni 1 herë butonin që dëshironi

Klikoni dy herë butonin

Klikoni dy herë butonin

Mënyra e njoftimit

Mënyra e fshirjes

Mënyra e prezantimit

A është i njohur dërguesi?

po

jo

Udhëzim:
Drita / spina me kodim vezullon me sekuenca prej 0,5 sek.

Udhëzim:
Drita / spina me kodim vezullon me sekuenca prej 4 sek.

Udhëzim:
Drita / spina me kodim vezullon 1 herë

Numri i dërguesve të njohur ≤ 3 copë

po

jo

< 15 sek.

> 15 sek.

< 15 sek.

> 15 sek.

Shtypni butonin ose

Shtypni butonin ose

Udhëzim:
dërguesi më i vjetër i njohur do të fshihet

të gjithë dërguesit do të fshihen

dërguesi i përdorur do të fshihet

Do të nisë prezantimi 1

Do të nisë prezantimi 2

Do të nisë prezantimi 3

Udhëzim:
Drita / spina me kodim vezullon 3 herë

dërguesi i ri do të përshtatet ose do të ruhet

Shtypni butonin që dëshironi

Udhëzim:
të gjithë dushet mbyllen

المعايير واللوائح:

- يتم ضمان استخدام المنتج من خلال اللوائح التالية:
- EN 15200
- EN 60335-2-105

التركيب: (راجع صفحة 303)



- **تنبيه!** يجب تركيب الوصلة واستخدامها واختيارها وفقاً للمعايير المعمول بها.) التركيب وفقاً للموصفة (EN 1717) أنظر دليل التركيب Raindance Rainfall 28411000 Raindance Rainmaker 28403000 / 28404000 / 28417000 / 28418000
- يلزم القيام بجميع الأعمال فقط في حالة فقط في حالة عدم وجود اتصال كهربائي على الإطلاق.
- لا يمكن تركيب الجسم الرئيسي 15941180 إلا بصورة رأسية فحسب! لا يمكن إجراء عملية التركيب باستخدام حلقة التركيب (أ) إلا في المنطقة الأمامية أو المنطقة الوسطى.
- يجب وضع جميع المكونات في مكان يسهل الوصول إليه.

تنبيهات الأمان:



- لا يجب استخدام نظام الدش إلا في أغراض الاستحمام والأغراض الصحية وأغراض تنظيف الجسم.
- غير مسموح للأطفال باستخدام نظام الدش بدون مراقبة من أشخاص بالغين.
- ممنوع استخدام نظام الدش بدون ملاحظة من البالغين سواء في حالة استخدامه من طرف أطفال أو البالغين يعانون من قصور جسدي أو عقلي أو عصبي يمنعهم من الإحساس بدرجات حرارة المياه. لا يسمح لأي شخص تحت تأثير تناول الكحول أو المخدرات من استخدام نظام الدش.
- يجب تجنب حدوث اتصال مباشر بين الماء الخارج من رأس الدش وبين أجزاء الجسم الحساسة (مثل العينين). يجب وجود مسافة كافية بين رأس الدش والجسم.
- يجب أن يكون تيار الماء الساخن والماء البارد متعادلين في الضغط.

المواصفات الفنية:

- الحد الأقصى 1 ميجاباسكال ضغط التشغيل:
- 0,5 - 0,1 ميجاباسكال ضغط التشغيل الموصى به:
- 1,6 ميجاباسكال ضغط الاختبار:
- (1 ميجاباسكال = 10 بار = 147 PSI)
- الحد الأقصى 80° C درجة حرارة الماء الساخن::
- 65° C درجة الحرارة الموصى بها للماء الساخن:
- ¼ G المسافة المركزية:
- مخلوط ماء الوصلات مندخل:
- معدل تدفق 0,3 ميجاباسكال:
- 1 المستهلك:
- 35 لتر / الدقيقة
- 45 لتر / الدقيقة
- 2 المستهلك:

توصيلة كهربائية:



- يتعين القيام بكافة أعمال التركيب والفحص من قبل فني كهرباء معتمد مع الأخذ في الاعتبار الالتزام بالمعيار VDE 0100 الجزء 701 و IEC 60364-7-701.
- يلزم فقط وجود مقبس واحد للتوصيلة الكهربائية يتم الإمداد بالكهرباء عن طريق محول خارجي.
- ممنوع وجود أية مواد قابلة للاشتعال بالقرب من المكان.
- لا يسمح بأن تتخطى درجة الحرارة المحيطة معدل 50 درجة مئوية.
- يتم الإمداد بالكهرباء عن طريق وصلة تيار متردد 230 فولت/نيون/باسكال/50 هيرتز.
- يتم التأمين من خلال تجهيزة حماية ضد اختلاف التيار (RCD/ FI) عند اختلاف التيار لأقل من أو يساوي 30 مللي أمبير.
- إذا كانت معادلة التردد الكهربائي ضرورية، فيجب هنا عمل ذلك على الجانب.
- يجب الالتزام بالقواعد السارية كل على حده عند عمل التركيبات الكهربائية، وذلك بالنظر إلى قواعد اتحاد الصناعات الإلكترونية (VDE)، وقواعد الدولة، وقواعد الاتحاد الأوروبي لفحص وتحليل الحوادث (EVU).
- يلزم ضمان إمكانية فصل المنتج عن الشبكة. وذلك إما من خلال قابس يمكن الوصول إليه بحرية أو من خلال مفتاح متعدد الأقطاب طبقاً لمواصفات EN 60335-1 الفقرة 24.3.

مكلمات: (راجع صفحة 284)



أبعاد: (راجع صفحة 292)



مثال على التركيب Raindance Rainfall: (راجع صفحة 295)



مثال على التركيب Raindance Rainmaker: (راجع صفحة 299)



التشغيل: (راجع صفحة 286)



- في حالة حدوث أي عطل بجهد الشبكة الذي يبلغ 230 فولت، قد يتعذر تشغيل وحدة الدش.
- لا يستخدم المنتج مع حمام بخار!

التنظيف مرشح الاتساخات: (راجع صفحة 309)



قطعة غيار: (راجع صفحة 311)

عربي بيانات تقنية

العطل	السبب	العلاج والإصلاح
لا توجد وظائف على الإطلاق	- لا توجد تغذية كهربائية - المحول بالمجموعة الأساسية عاطل - جهاز الاستقبال يوجد في مكان غير مناسب / عاطل - جهاز الإرسال غير مبرمج / عاطل	- تأكد من سريان الإمداد بالكهرباء - استبدل المحول - قم بتغيير موقع جهاز الاستقبال أو استبدله - قم ببرمجة جهاز الإرسال / قم باستبداله
لا يمكن تهيئة نسق التشغيل	- التوصيلة الريشية غير موجودة في مكانها المناسب خلف الجلبة - التوصيلة الريشية بها خطأ	- ضع التوصيلة الريشية على الجلبة - قم باستبدال التوصيلة الخاصة بالصمام المغناطيسي
لا توجد وظيفة إضاءة	- محول Rainmaker غير موصل / به خطأ - توصيلات مرحل الضوء بها خطأ / عاطلة	- تأكد من سريان الإمداد بالكهرباء للمحول / قم باستبدال المحول - قم باختبار الوصلات ومرحل الضوء / قم باستبدال الوصلات
يغلق المستهلكون بأنفسهم	- تم حفظ مدة التشغيل في نسق البرمجة	- قم بتمديد وقت التشغيل بعد العمل في نسق الخدمة / قم بإغلاق
خلاط المياه غير محكم	- الصمام المغناطيسي متسخ / عاطل	- قم بتنظيف جلبة الصمام المغناطيسي / قم باستبدالها
الانسحاب قليل للغاية	- مصفاة الانساحات في ناحية المدخل متسخة	- قم بتنظيف / تغيير مرشح الانساحات

رموز

معادلة الجهد الكهربائي		محول		توصيلة مياه DN 20 ماء دافئ	
إيقاف تشغيل جميع الوحدات		جهاز الاستقبال		توصيلة مياه DN 20 ماء بارد	
اللمبة		قابس		افتح خلاط المياه	
Rain		230V		قم بإيقاف المياه	
Whirl		12V		من • الوظيفة مضمونة	
Rainflow		ماسورة فارغة		يجب أن تكون قدرة الصرف أأبر من 50 لتر/دقيقة	
Rain AIR XXL		توجيه الإضاءة (27189000 غير مدرج!)		تصريف	
Rain AIR		Rainmaker	مرحل الضوء	Raindrain	
سيليكون (خالي من حمض الخليك!)		Rainmaker	محول	بانيو مزود بدش في المنتصف	
				توجد على الجانب توصيلة 12 فولت للإضاءة (بحد أقصى 80 وات)	

الترتيب راجع صفحة 303

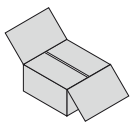

عربي مكملات

ولا يسمح بتقصير الكابل الثانوي للمحول والذي يبلغ طوله حوالي 7 م. يجب وضع الجزء غير الضروري من الكابل بالقرب من المحول الأمان. لا يسمح باستبدال أية وصلة تالفة. وفي هذه الحالة، لا يسمح بتشغيل المحول. لا يسمح باستبدال أية وصلة تالفة. يجب أن يتم استبدال توصيلة الكهربياء والمحول بواسطة عامل متخصص إذا كان بالتوصيلة خلل.

تبلغ قدرة المحول الخارجي 50 فولت أمبير. كما يتعين تركيب المحول في منطقة جافة (منطقة الحماية الثالثة). يمكن تركيب المحول مع جهاز الاستقبال في علبة بلاستيك مع مراعاة المعيار (EN/IEC 60335-1 الأبعاد حوالي 92 × 160 × 250 مم، لا يوجد الأنبوب ضمن المواد الموردة). يسمح الكابل المورد بالقيام بعملية تركيب المحول على بعد يصل إلى 7 أمتار من جهاز الاستقبال . ولذا، فيجب توفير أنبوب فارغ (EN35 لا يوجد الأنبوب ضمن المواد الموردة). (يجب تثبيت الأنبوب الفارغ على الأقل كل 500 مم كما يجب أن يكون نصف قطر الثني أكبر من 100 مم .

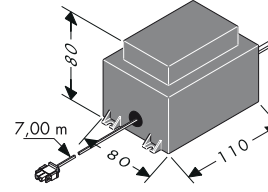

محول:

(فقط للموديلات بإضاءة مدمجة)
يجوز تحميل مرحل الضوء بتيار متردد 12 فولت/ 80 وات بحد أقصى.
لا يسمح بالتشغيل بشبكة 230 فولت.

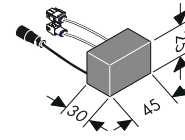

مرحل الضوء:

(iControl mobile 15944000)
يلزم توصيل توجيه الإضاءة في حالة المنتجات التي بها مصادر إضاءة خارجية. يجب أن تتوفر دائماً إمكانية الوصول لتوجيه الإضاءة.

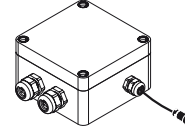

توجيه الإضاءة:

27189000

(محتويات المسلمة غير مدرج مع ال)

(Raindance Rainfall 28411000 /
Raindance Rainmaker 28403000)
يجب توصيل القابس بالنسبة للأشكال غير المزودة بلمبة. عندما يتم تنشيط وضع الصيانة بالنسبة للأشكال غير المزودة بلمبة، تشير لمبة القابس إلى الإشارات المرجعية البصرية.
يجب أن يكون الوصول لقابس الكود ممكناً دائماً.

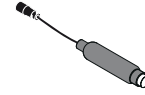

قابس:

تنبيه: لا يسمح بتوصيل أية كابلات كهربائية يزيد جهدها عن 12 فولت في الأنابيب الفارغة لكابل الصمام المغناطيسي والكابل الضوئي.

لا يسمح بتقصير كابل الصمام المغناطيسي التي يبلغ طوله 7,50 م والكابل الضوئي الذي يبلغ طوله 10 م. يجب وضع الجزء غير الضروري من الكابل بالقرب من جهاز الاستقبال.

يسمح بتوصيل كابل الصمام المغناطيسي والكابل الضوئي في الأنبوب الفارغ الذي تم توريده (EN20) فحسب. يجب تثبيت الأنبوب الفارغ على الأقل كل 500 مم كما يجب أن يكون نصف قطر الثني أكبر من 100 مم.

الوصلة صمام المغناطيس / الوصلة اللمبة :



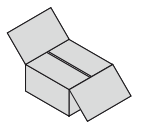

من أجل التعرف على الإشارات اللاسلكية على أكمل وجه، يجب تخصيص الهوائي الخاص بجهاز الاستقبال لجهاز الإرسال بقدر الإمكان.

يفضل تركيب جهاز الاستقبال في نفس المكان مثل وحدة الدش. إذا كان ذلك غير ممكن، يمكن تركيب جهاز الاستقبال في مكان يحيط بوحدة الدش. لا يسمح بتركيب جهاز الاستقبال في علبة معدنية حيث أنه يتم عزل الإشارات اللاسلكية لجهاز الإرسال. فضلاً عن ذلك فيجب الأخذ في الاعتبار أن يوجد عدد قليل من الأجزاء المعدنية المعزولة بقدر الإمكان بالقرب من مكان تركيب جهاز الاستقبال.

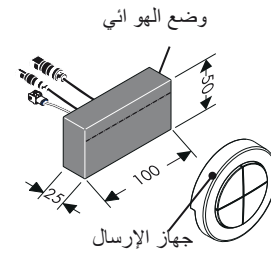

جهاز الاستقبال:

ملحوظة: لدواعي أمنية يجب استخدام جهاز الإرسال فقط في مجال الرؤية لنظام الدش. وإلا فسيتم فتح المياه بدون قصد.

عند التسليم يجب تهيئة جهاز الإرسال وفقاً لجهاز الاستقبال. من خلال أرقام التعريف المسلسلة يمكن تخصيص جهاز الإرسال لجهاز الاستقبال. يتعين ضبط كافة أجهزة الإرسال الإضافية والتي يتم الحصول عليها فيما بعد. يمكن ضبط وحفظ أربعة أجهزة إرسال بحد أقصى. راجع صفحة 2_ نسق التسجيل. كما يبلغ التردد اللاسلكي لجهاز الإرسال 868,3 ميجا هرتز.

ملحوظة: كيفية استبدال أي جهاز إرسال تالف بجهاز إرسال سليم بصورة صحيحة:
1. إلغاء جميع أجهزة الإرسال. (نسق التسجيل □ وضع الإلغاء).
2. يتعين ضبط جميع أجهزة الإرسال مرة أخرى باستثناء جهاز الإرسال التالف. (وضع الصيانة □ نسق التسجيل).



جهاز الإرسال:

ملحوظة: يتميز جهاز الاستقبال والإرسال بنطاق تغطية يصل إلى 10 م تقريباً. ويتوقف نطاق التغطية على مدى قوة تخفيف الإشارات اللاسلكية بين جهاز الإرسال وجهاز الاستقبال.

التخفيف	المواد
0 - 10 %	الخشب والجبس والزجاج (غير مطلية بدون معادن).
5 - 35 %	طوب وألواح ضغط
10 - 90 %	خرسانة مع حديد مسلح
90 - 100 %	معادن وصفائح ألومنيوم

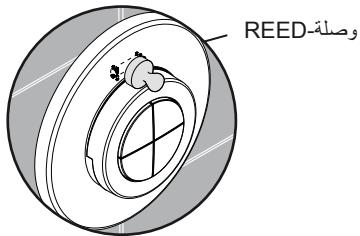

لتشغيل حالة الخدمة يجب أن تكون الوصلة REED المغناطيسية (خلف الجلبة) في حالة التشغيل. راجع صفحة 288 / 289_ وضع الصيانة.



مغناطيس:

Raindance Rainfall

28411000

iControl mobile

15940180 / 15942000

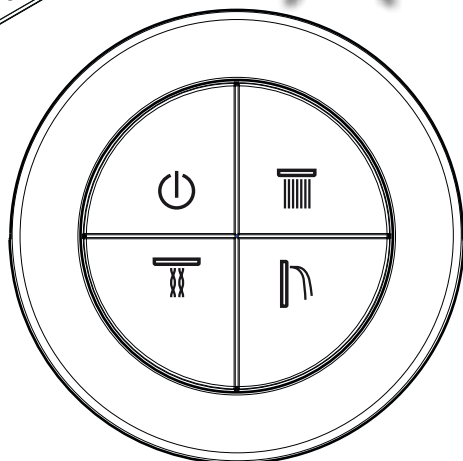
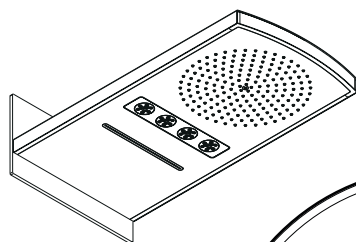

Raindance Rainfall

28411000

iControl mobile

15941180 / 15944000

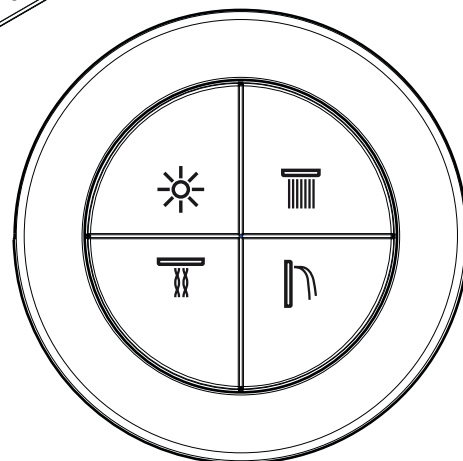
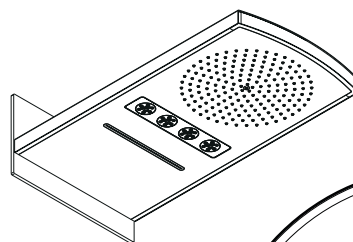

Raindance Rainmaker

28403000

iControl mobile

15940180 / 15943000

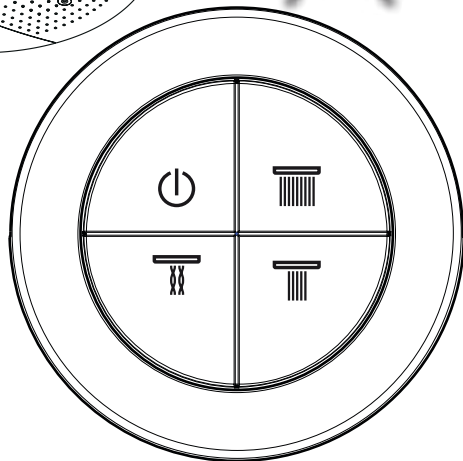
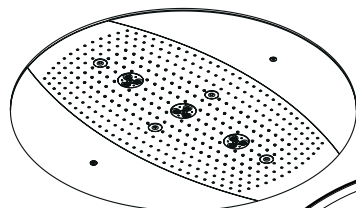

Raindance Rainmaker

28404000

iControl mobile

15941180 / 15945000

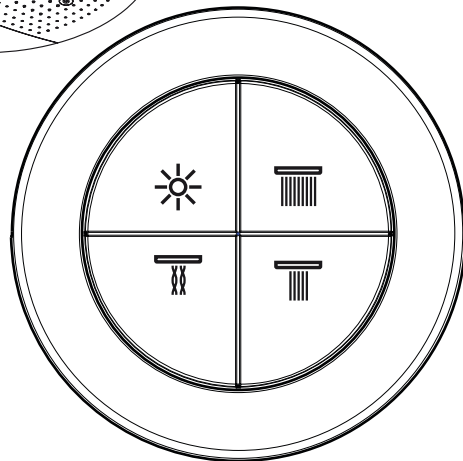
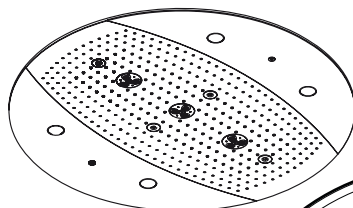

Rain



Whirl



Rainflow



Rain AIR XXL

Rain AIR

فتح وإغلاق الدش واللمبة:
(الوظيفة القياسية مع اللمبة)

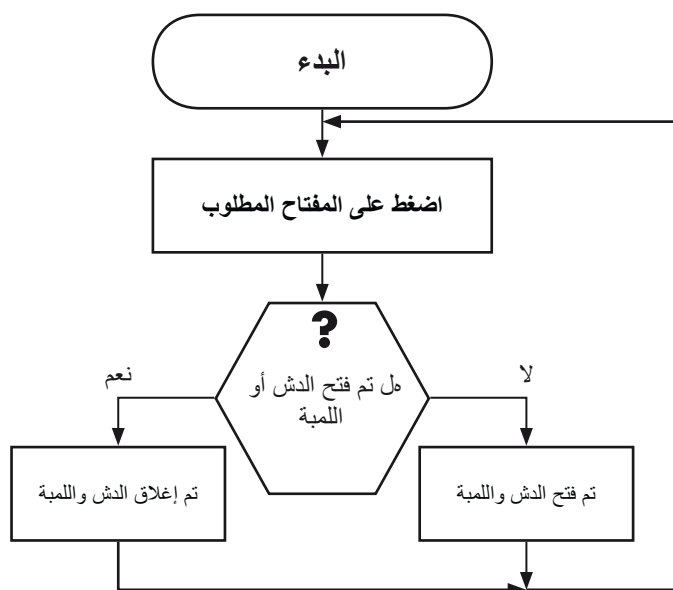

فتح وإغلاق الدش:
(الوظيفة القياسية بدون اللمبة)

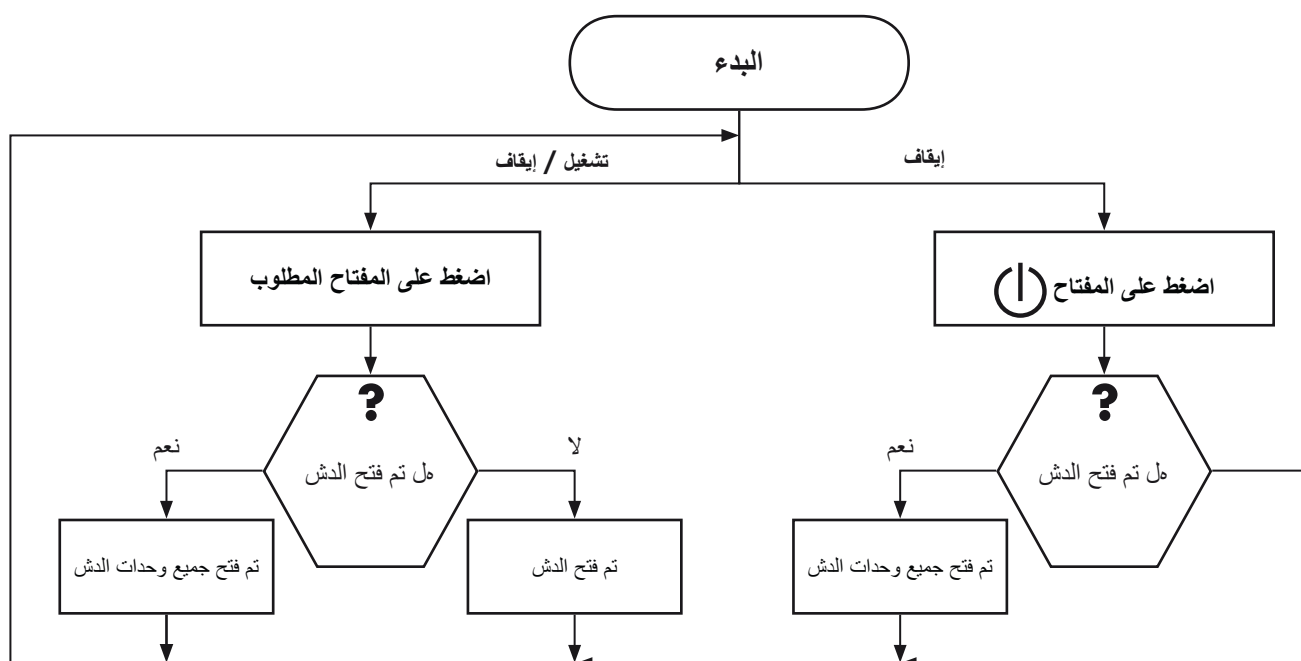

Raindance Rainfall
28411000

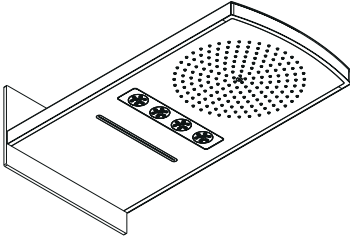

وضع التشغيل

ملحوظة: !



ملحوظة: !
انطفاء اللبة / القابض

وضع الصيانة

ملحوظة: !
وميض اللبة / القابض 4 مرات

ملحوظة: !
وميض اللبة / القابض 2 مرات

15 < ثانية

15 > ثانية

انقر المفاتيح  أو  مرتين

انقر المفاتيح مرتين 

وضع الحد الأقصى من زمن التشغيل

ملحوظة: !
وميض اللبة / القابض 1 ثانية واحدة

وضع الدش

ملحوظة: !
وميض اللبة / القابض 2 ثانية واحدة

15 < ثانية

15 > ثانية

15 < ثانية

15 > ثانية

اضغط على المفاتيح  أو 

اضغط على المفاتيح 

اضغط على المفاتيح 

اضغط على المفاتيح 

اضغط على المفاتيح  أو 

اضغط على المفاتيح 

أوقات التشغيل:
الدش: 30 ثانية
اللمبة: 30 الدقيقة

المقياس:
أوقات التشغيل:
الدش: 60 ثانية
اللمبة: 30 الدقيقة

أوقات التشغيل:
الدش: 180 ثانية
اللمبة: 30 الدقيقة

أوقات التشغيل:
الدش +
اللمبة:
غير محددة

المقياس:
نكلمي حتف
يتدحو شد دحب
يصرقاً

الراحة 1:
يمكن فتح جميع
وحدات الدش في
وقت واحد.

Raindance Rainmaker
28403000 / 28404000

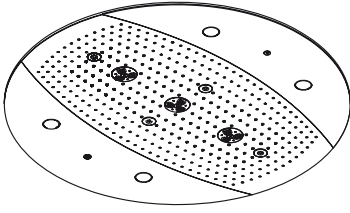

وضع التشغيل

ملحوظة: !

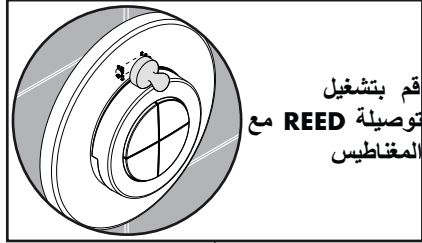

ملحوظة: !
انطفاء اللبة / القابس

وضع الصيانة
ملحوظة: !
وميض اللبة / القابس 4 مرات

ملحوظة: !
وميض اللبة / القابس 2 مرات

15 < ثانية

15 > ثانية

انقر المفاتيح أو مرتين

انقر المفاتيح مرتين

وضع الحد الأقصى من زمن التشغيل
ملحوظة: !
وميض اللبة / القابس 1 ثانية واحدة

وضع الدش
ملحوظة: !
وميض اللبة / القابس 2 ثانية واحدة

15 < ثانية

15 > ثانية

15 < ثانية

15 > ثانية

اضغط على المفاتيح أو

اضغط على المفاتيح

اضغط على المفاتيح

اضغط على المفاتيح أوقات التشغيل:

اضغط على المفاتيح أو

اضغط على المفاتيح

اضغط على المفاتيح

أوقات التشغيل:
الدش: 30 ثانية
اللمبة: 30 الدقيقة

المقياس:
أوقات التشغيل:
الدش: 60 ثانية
اللمبة: 30 الدقيقة

أوقات التشغيل:
الدش: 180 ثانية
اللمبة: 30 الدقيقة

الدش +
اللمبة:
غير محددة

المقياس:
نكفي حتف
يتدحج شد دحب
يصرقاً

الراحة 1:
يمكن فتح جميع
وحدات الدش في
وقت واحد.

الراحة 2:
يمكن ضبط أمية مياه
أبر إذا أن هناك
ضرورة لذلك عند
ترايب وحدة ضح
المياه (Rainmaker)

Raindance Rainfall
28411000

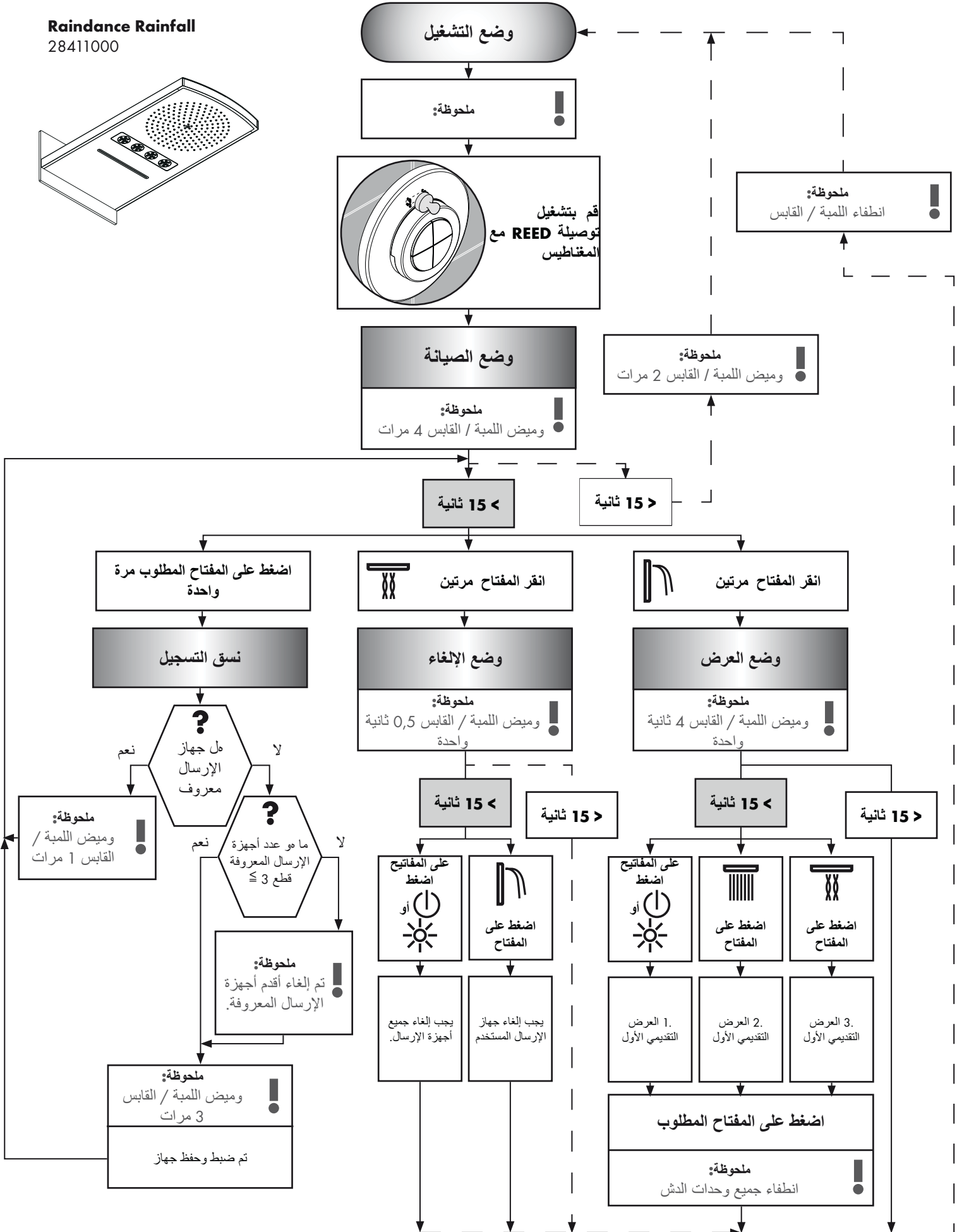
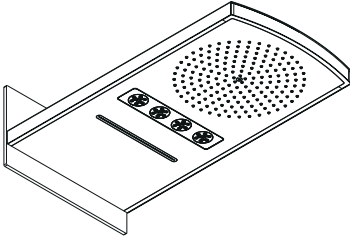

Raindance Rainmaker
28403000 / 28404000

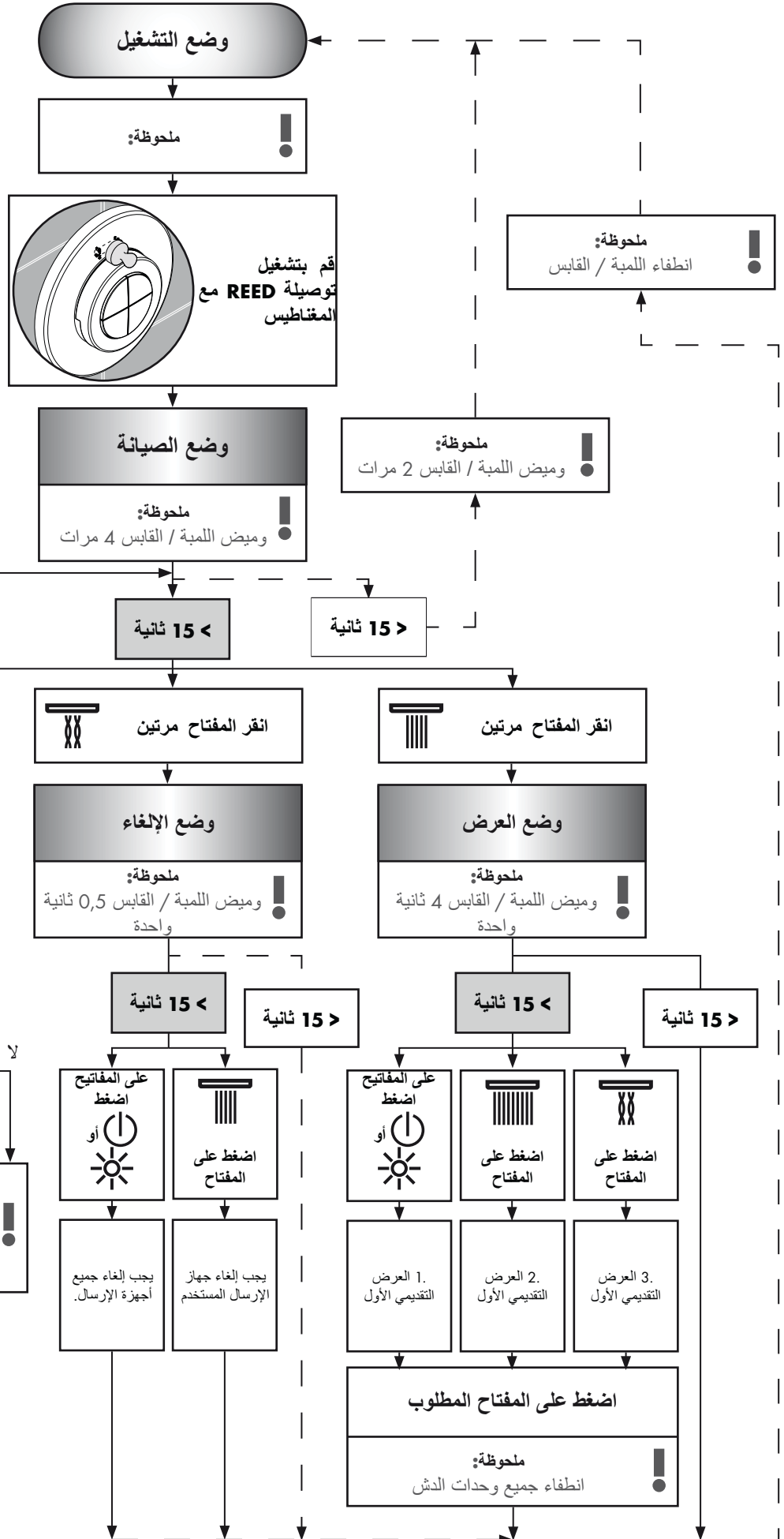
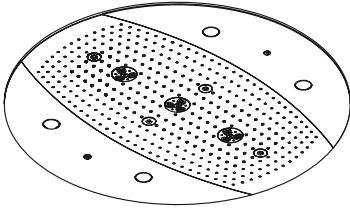

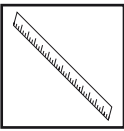

iControl mobile

15942000 / 15943000 / 15944000 / 15945000

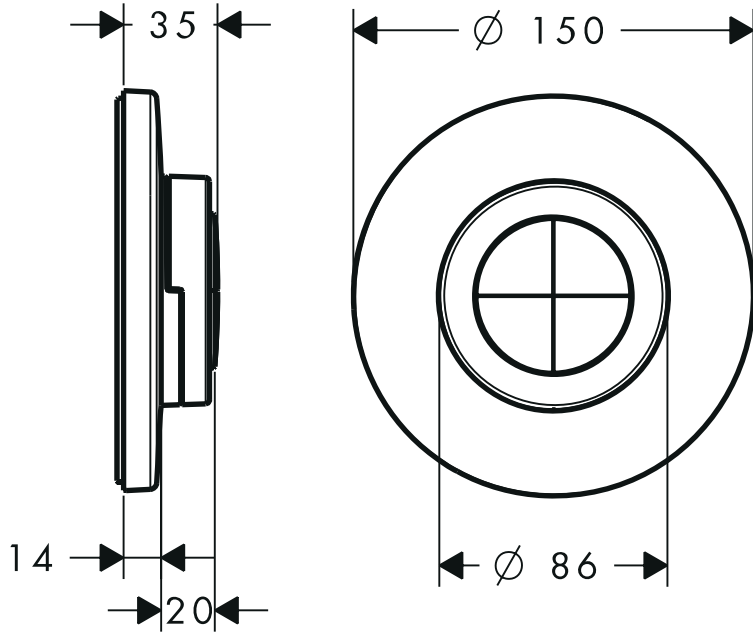

iControl mobile

15941180

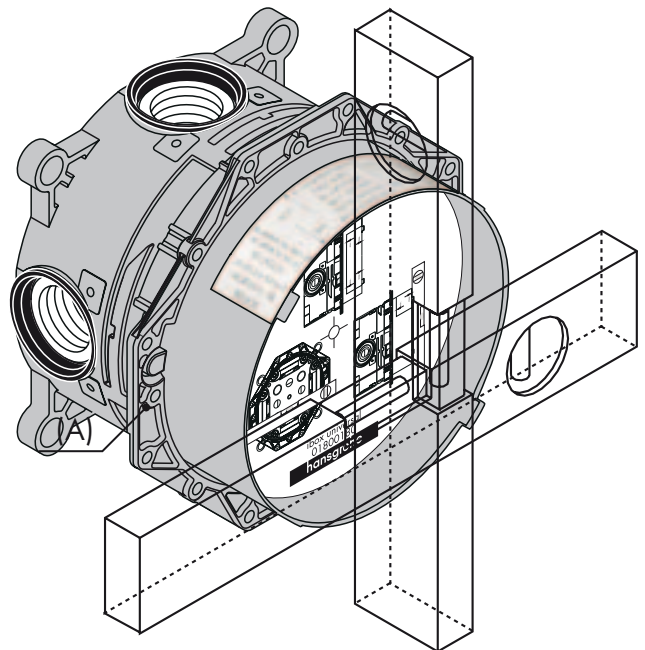

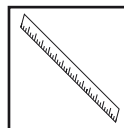

iControl mobile
15943000 / 15945000

Raindance Rainmaker
28403000 / 28404000

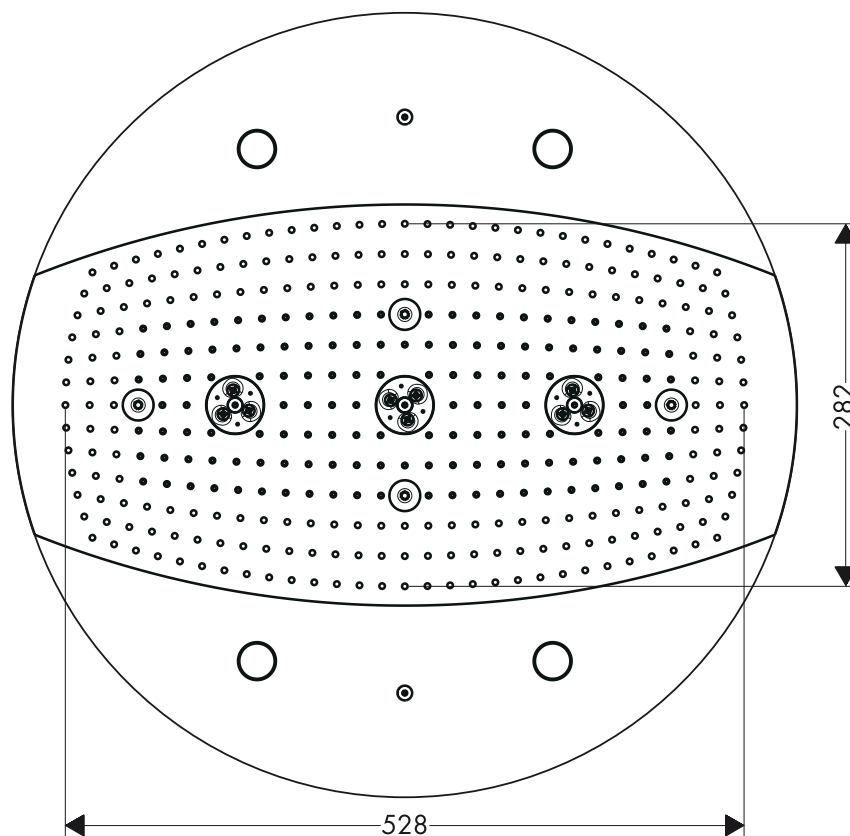
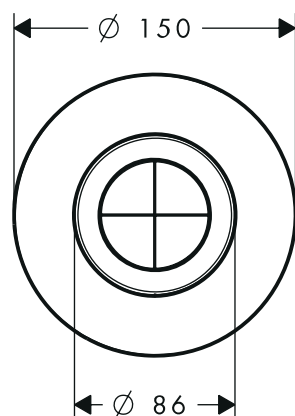
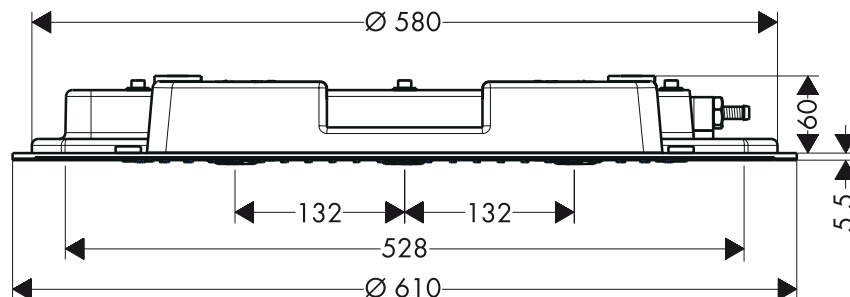
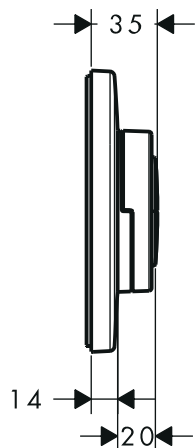

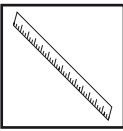

Raindance Rainfall
28411000

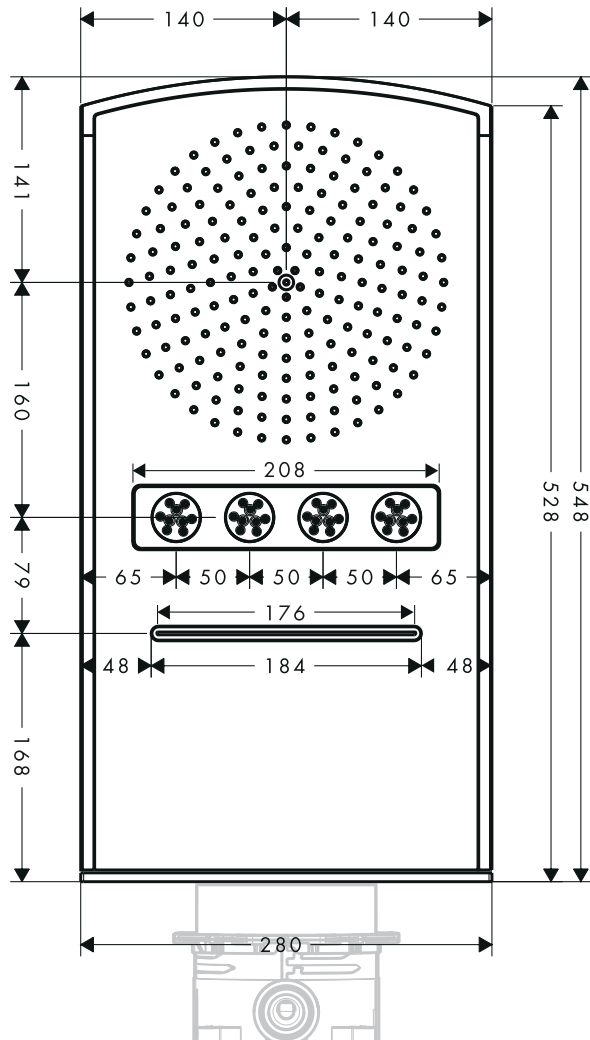
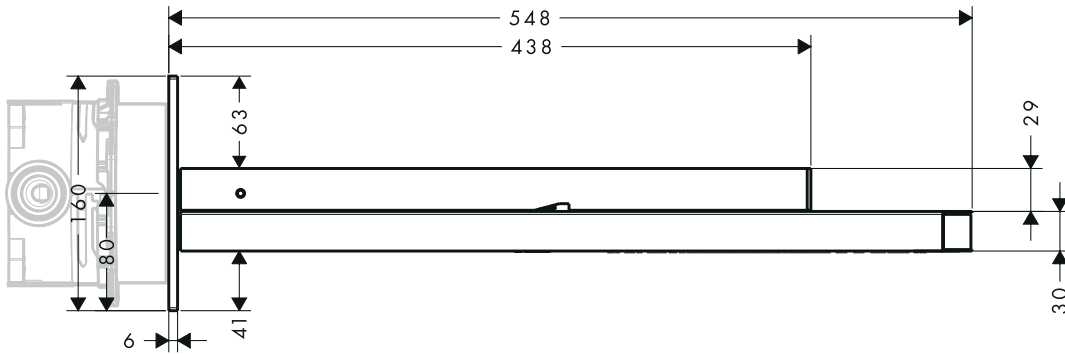

Raindance Rainfall

28411000

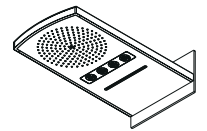

- | | | |
|--|--|--|
| DE Wandverstärkung für Rainfall-Befestigung notwendig | CS Pro upevnění systému Rainfall je nutné zesílení stěny | RO Pentru fixare este nevoie de consolidarea peretelui |
| FR Renforcement nécessaire pour fixation Rainfall | SK Je nevyhnutné zosilniť stenu pre pripevnenie Rainfall | EL Απαραίτητη είναι και μία ενίσχυση του τοίχου στο σημείο στερέωσης του Rainfall |
| EN Wall reinforcement required for Rainfall mounting | ZH 对加强“降雨量”来说加固边避不可或缺。 | SL Za pritrditev prhe Rainfall je potrebno ojačenje stene |
| IT Necessario un rinforzo parete per il fissaggio del Rainfall | RU Требуется укрепление стены для монтажа Rainfall | ET Rainfalli kinnitamiseks tuleb seinat toetada |
| ES Es necesario un refuerzo del muro para el soporte-Rainfall. | HU A Rainfall rögzítéséhez a fal megerősítése szükséges. | LV Lai piestiprinātu „Rainfall”, nepieciešams nostiprināt sienu |
| NL Muurversterking noodzakelijk voor de bevestiging van de Rainfall | FI Rainfallin kiinnitykseen tarvitaan seinän vahvistus. | SR Za pričvršćivanje elementa Rainfall potrebno je ojačanje zida |
| DK Vægforstærkning nødvendig til montering af Rainfall | SV Väggförstärkning nödvändig för Rainfall-montering | NO Det er nødvendig med en veggforsterkning for feste av Rainfall |
| PT É necessário um reforço de parede para a fixação Rainfall | LT Būtino sienos sutvirtinimo sritis | BG Необходимо е подсилване на стената за закрепване на Rainfall |
| PL Dla funkcji Rainfall konieczne jest wzmocnienie ściany | HR Za pričvršćivanje elementa Rainfall potrebno je ojačanje zida | SQ Përforcimi i murit për montimin e pajisjes Rainfall është i nevojshëm |
| | TR Yağmur damlası sabitlemesi için duvar güçlendirmesi gereklidir | AR Rainfall يجب توفر تثبيت على الحائط لـ |

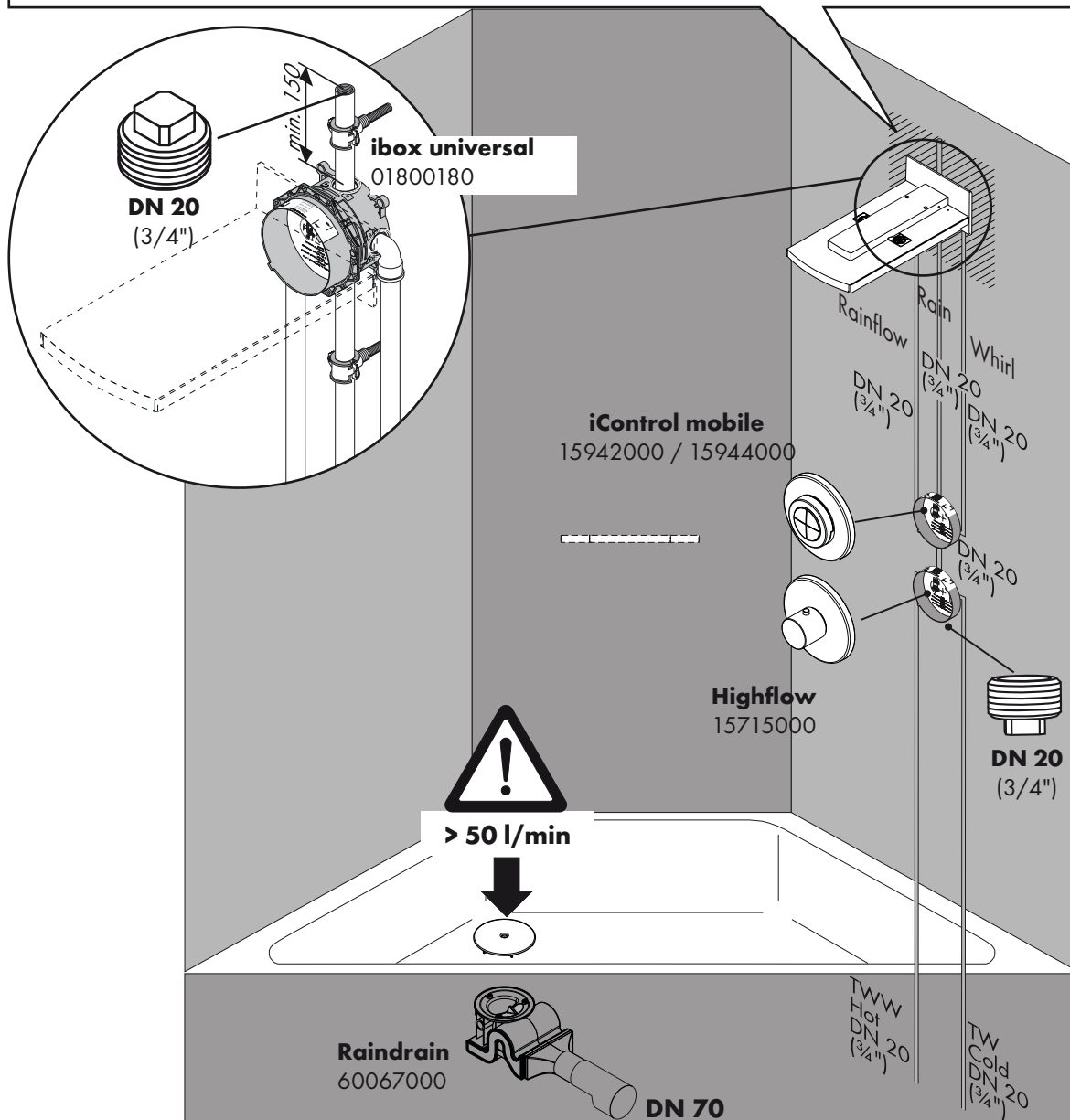

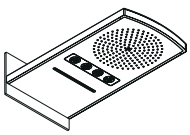

Raindance Rainfall

28411000

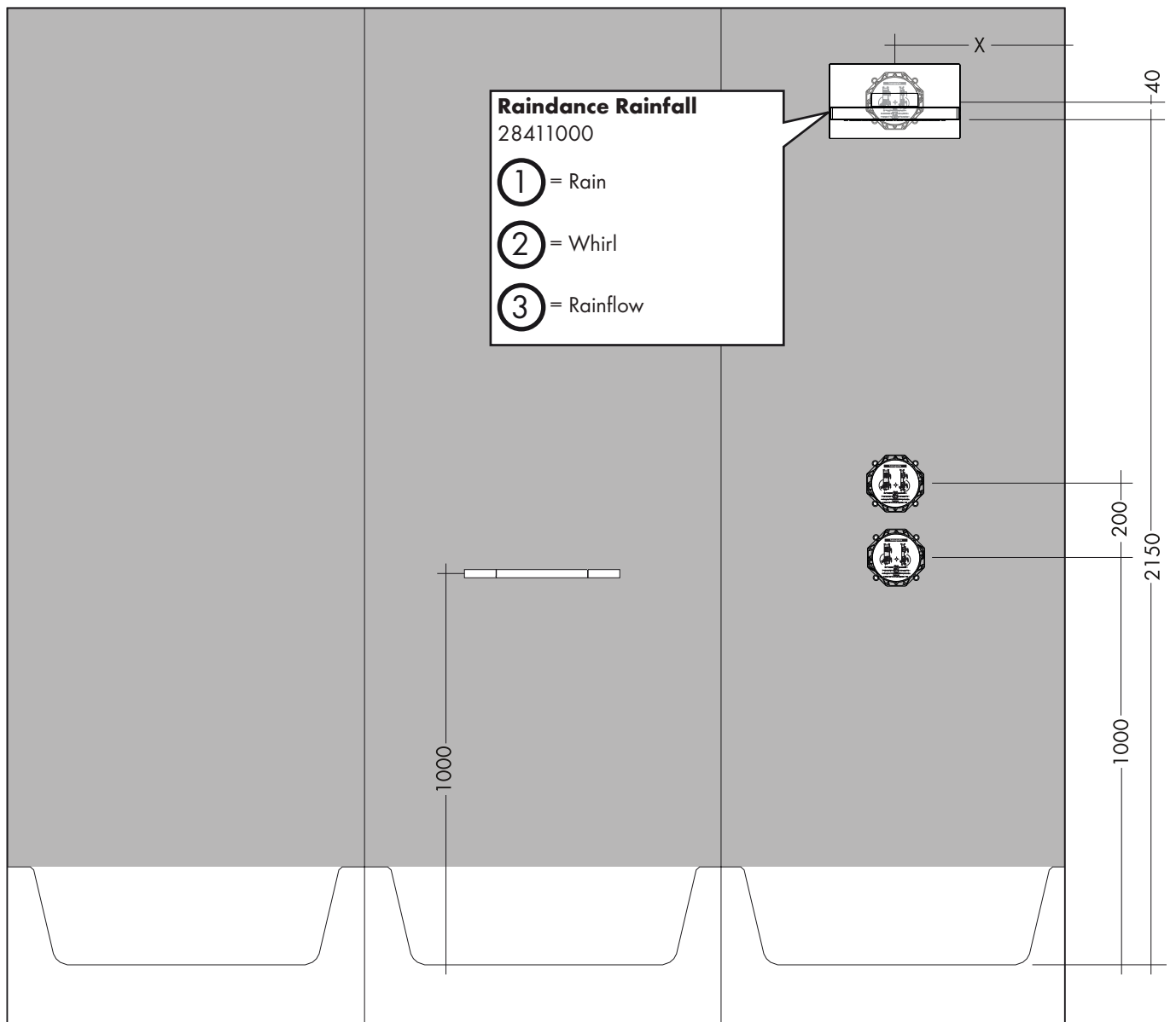
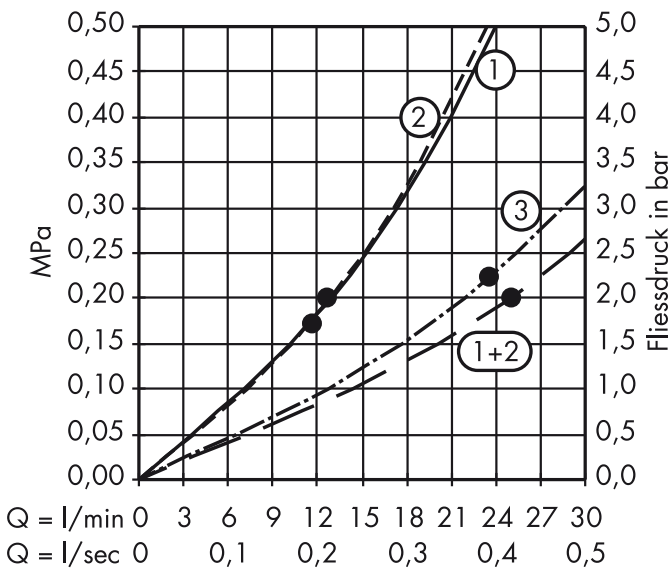

Raindance Rainfall

28411000

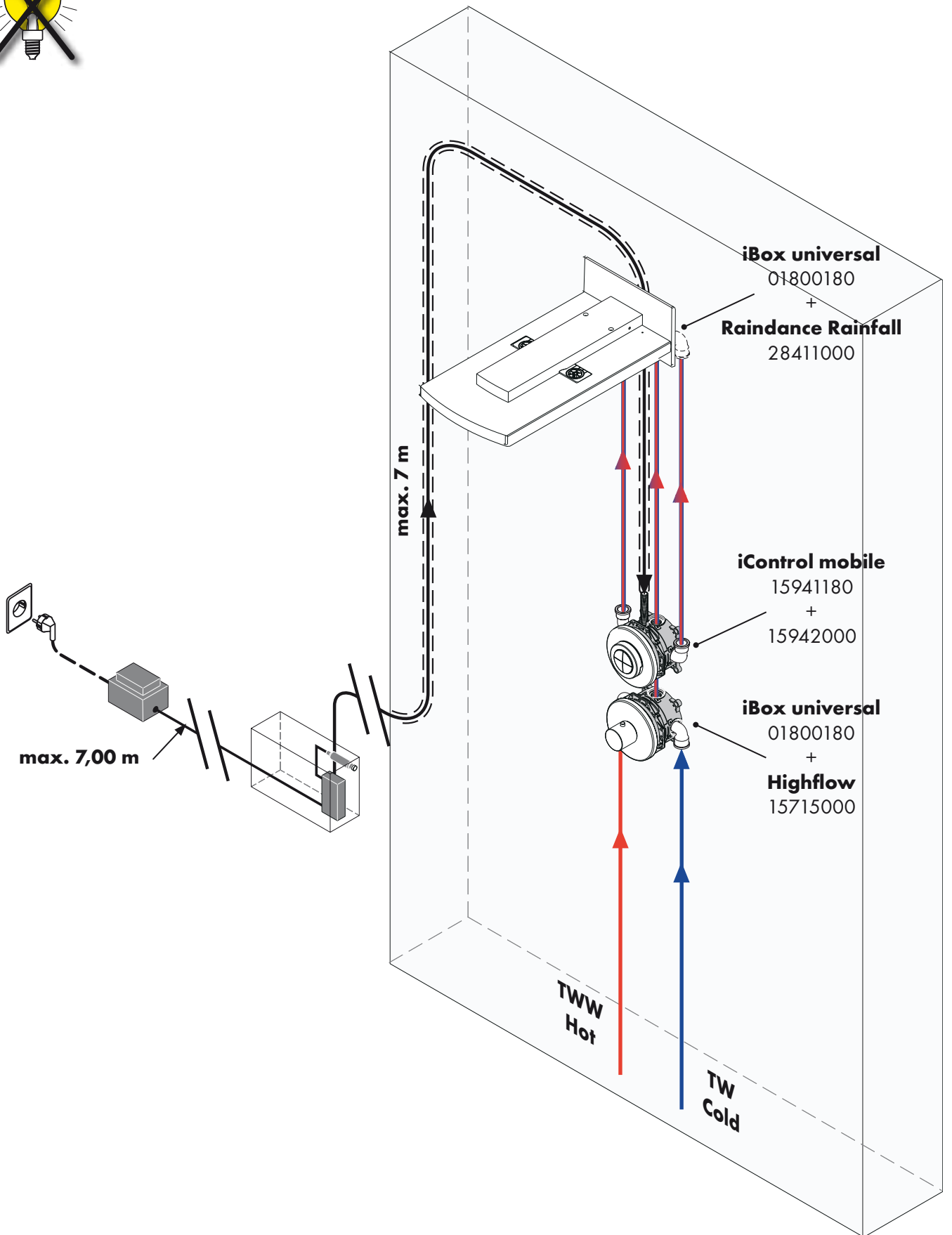
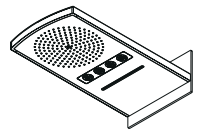

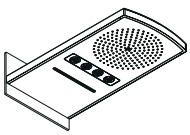

Raindance Rainfall

28411000

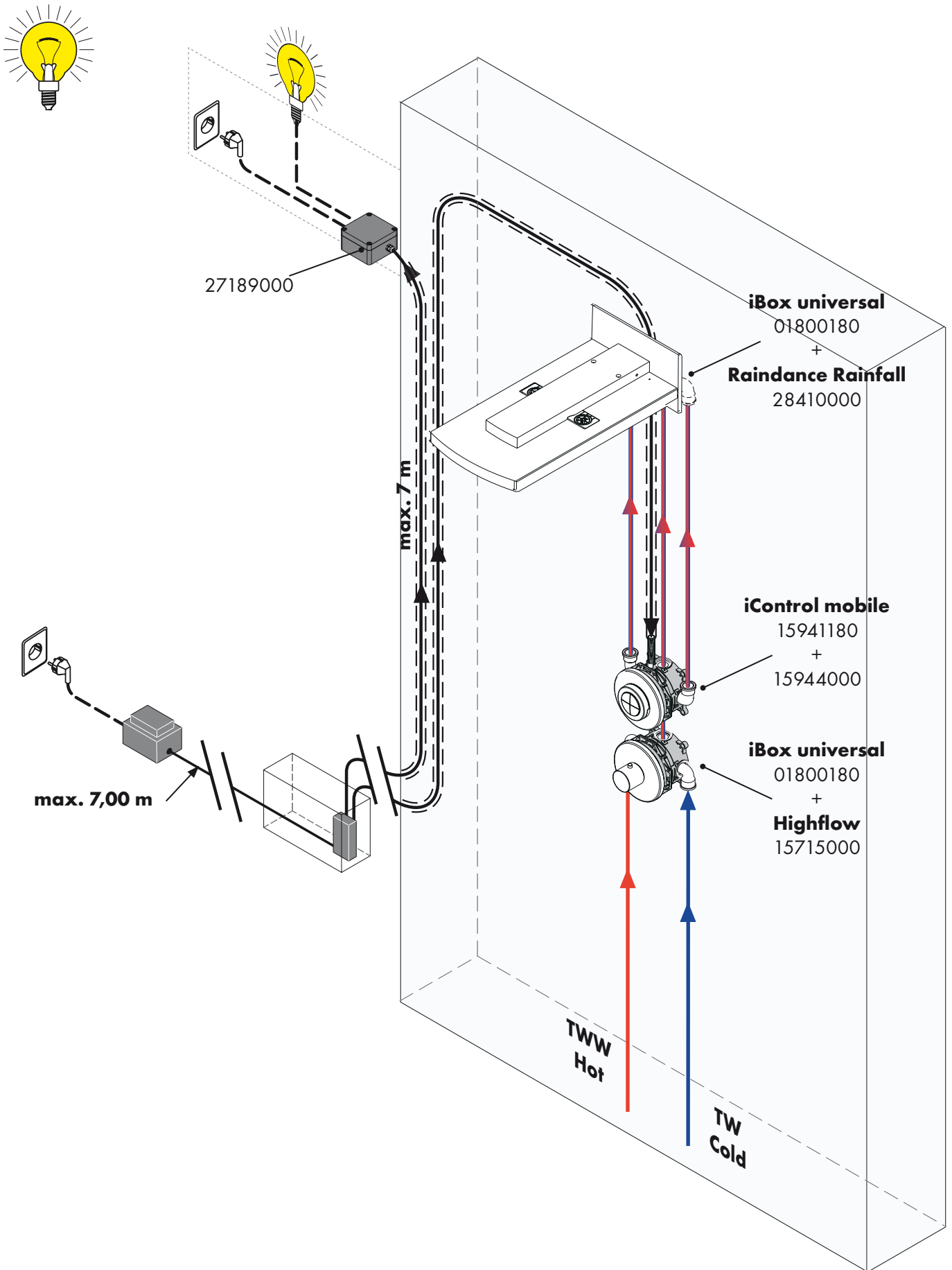

Raindance Rainmaker

28403000 / 28404000

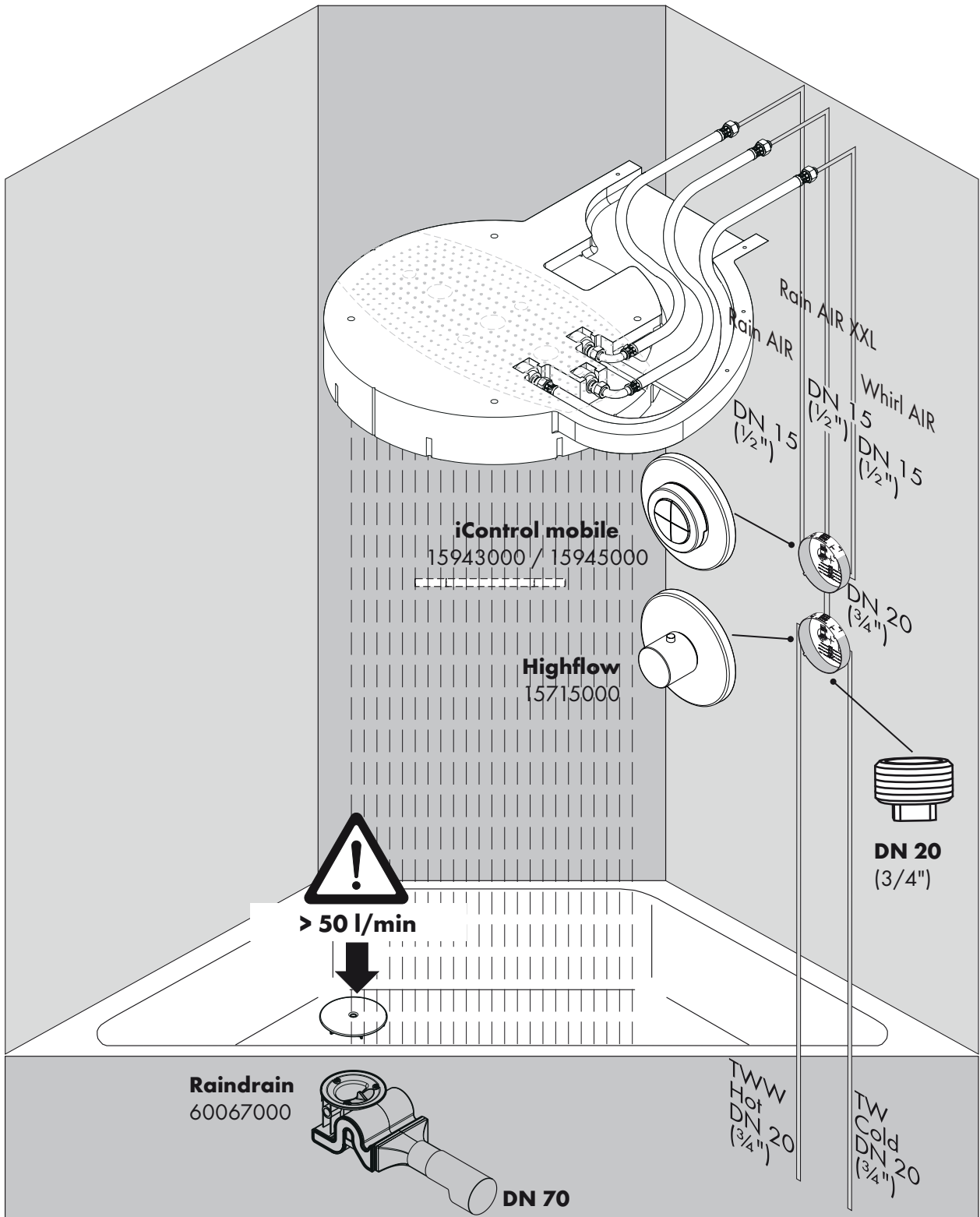
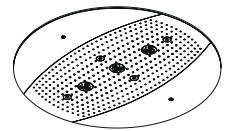

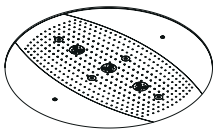

Raindance Rainmaker

28403000 / 28404000

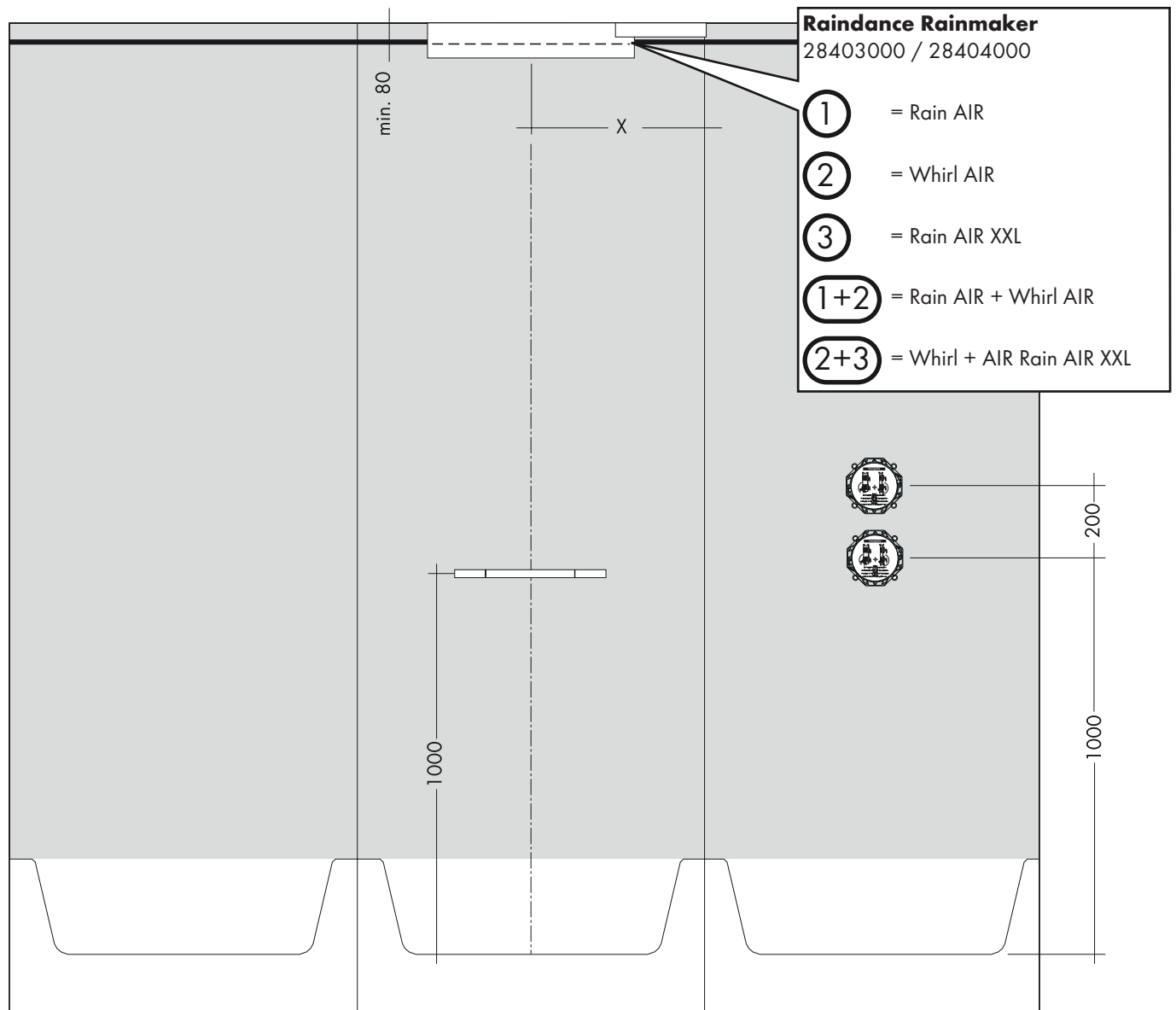
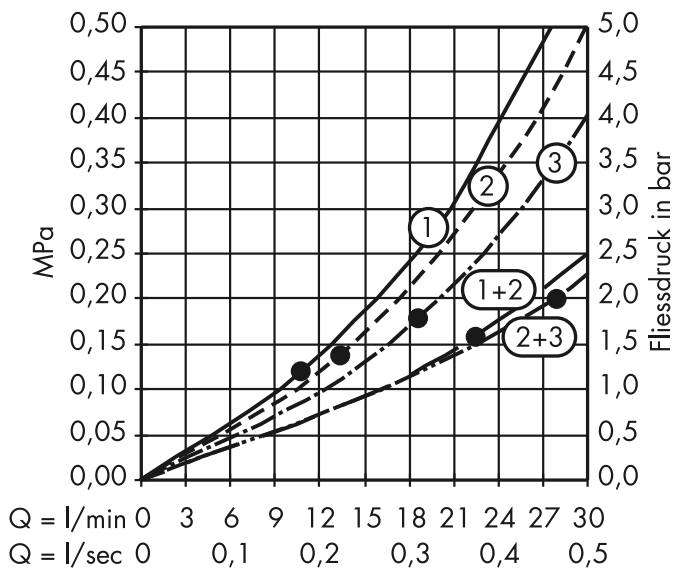

Raindance Rainmaker

28403000

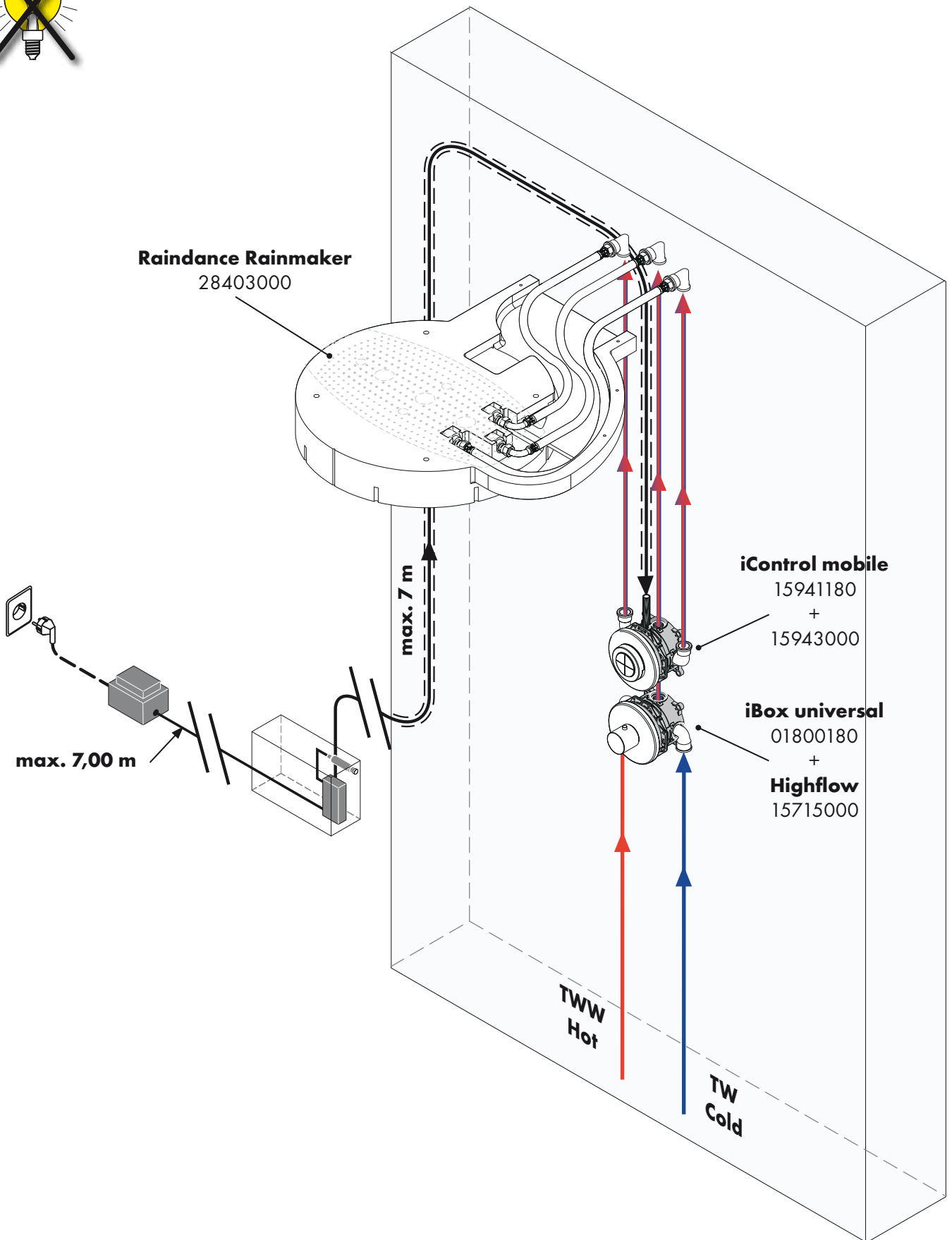
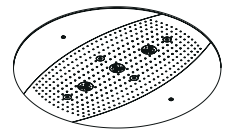

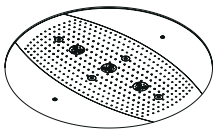

Raindance Rainmaker

28404000

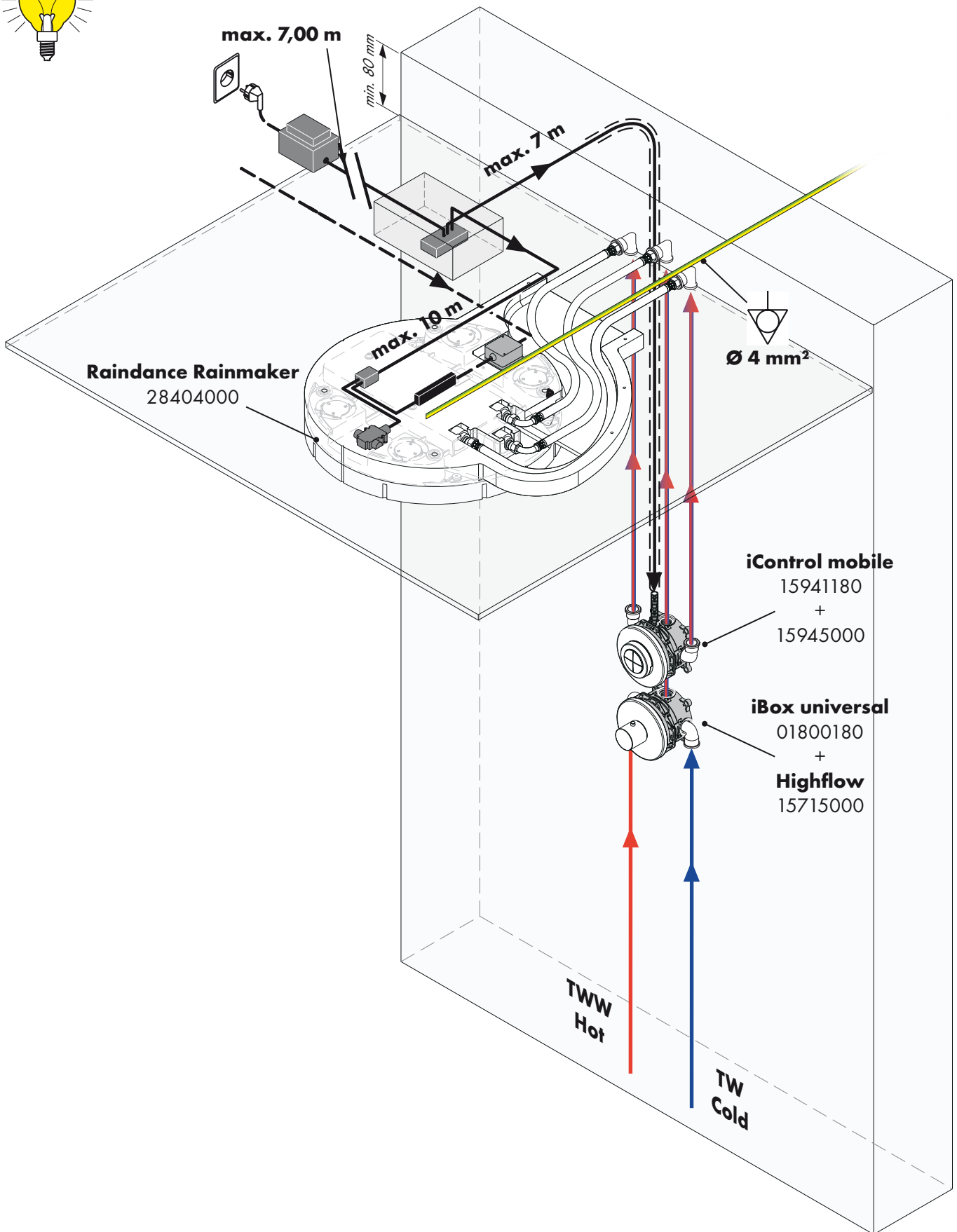

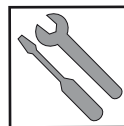

Montage
Assembly
Montaggio
Montaje
Montering
Montagem
Montaž
Montáž
安裝

Монтаж
Szerelés
Asennus
Montering
Montavimas
Sastavljanje
Montaži
Montare
Συναρμολόγηση

Montaža
Paigaldamine
Montáža
Montaža
Montasje
Монтаж
Montimi
الترايب

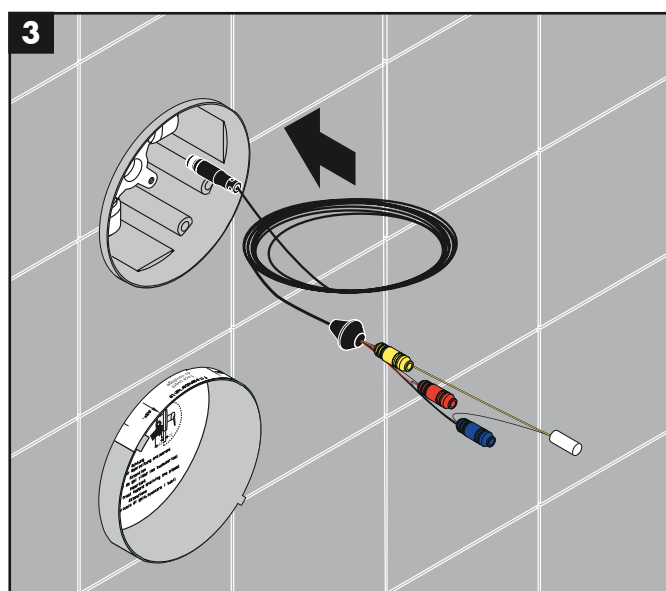
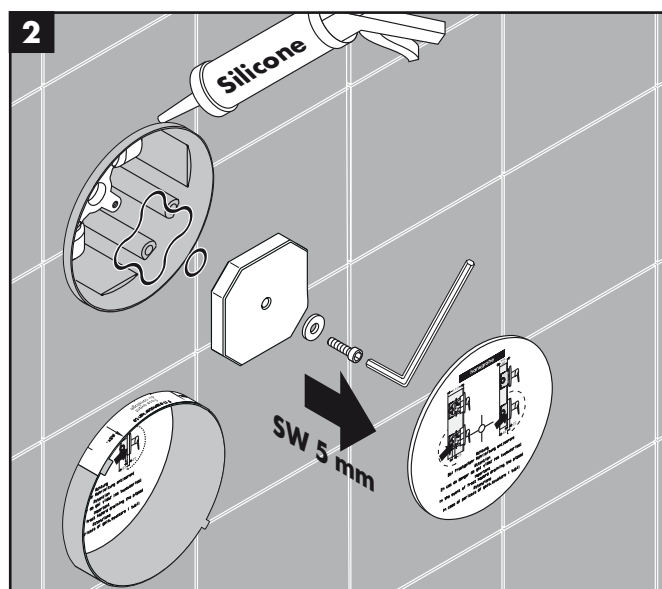
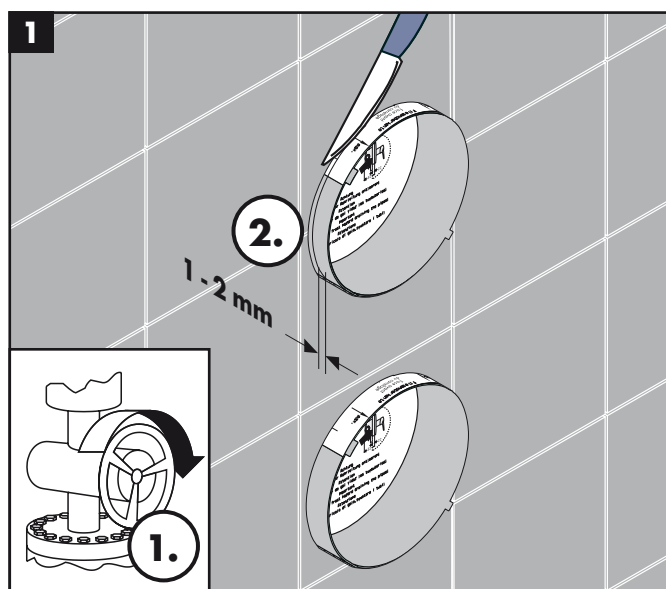

DE Magnetventilleitung mit Hilfe eines Kabeleinzuggerätes in das Leerrohr (EN 20) einziehen.

Die Magnetventilleitung kann nur vom Magnetventilblock in Richtung Empfänger eingezogen werden.

FR A l'aide d'un tire-fil, passer le câble d'électrovannes dans la gaine supplémentaire (EN 20).

Le câble d'électrovannes ne peut être passé qu'en partant de l'îlot d'électrovannes vers le récepteur.

EN Pull the solenoid valve line into the empty pipe by means of a cable puller (EN 20).

The solenoid valve line can only be retracted from the solenoid valve block in the direction of the receiver.

IT Tirare il cavo dell'elettrovalvola nel tubo vuoto (EN 20) con l'aiuto di un attrezzo tira-cavo.

Il cavo dell'elettrovalvola può essere tirato solo dal blocco elettrovalvole in direzione del ricevitore.

ES Introducir el cable de válvula magnética con ayuda de un dispositivo para tracción de cables en el tubo vacío (EN 20). El cable de válvula magnética únicamente se puede introducir desde el bloque de válvulas magnéticas y tirando en la dirección del receptor.

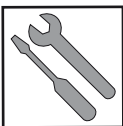

- NL** Magneetventielleiding met behulp van een kabeltrektoestel in de lege buis (EN 20) trekken.
De magneetventielleiding kan alleen door het magneetventielblok in de richting van de ontvanger getrokken worden.
- DK** Træk magnetventilledningen ind i det tomme rør (EN 20) ved hjælp af en kabeltrækker.
Magnetventilledningen kan kun trækkes ind i retningen modtageren fra magnetventielblokken.
- PT** Inserir o cabo da válvula magnética com a respectiva ferramenta no tubo vazio (EN 20).
O cabo da válvula magnética só pode ser inserido a partir do bloco da válvula magnética na direcção do receptor.
- PL** Wciągnąć przewód zaworu elektromagnetycznego za pomocą urządzenia do wciągania kabli do rurki kablowej (EN 20).
Przewód zaworu elektromagnetycznego można wciągnąć tylko z bloku zaworu elektromagnetycznego w kierunku odbiornika.
- CS** Vedení elektromagnetického ventilu zaveďte pomocí zaváděcího nástroje do ochranné trubky (EN 20).
Vedení elektromagnetického ventilu lze zavádět pouze od modulu elektromagnetického ventilu ve směru k přijímači.
- SK** Vsuňte vedenie magnetického ventilu s pomocou nástroja na vŕahovanie káblov do ochrannej trubky (EN 20).
Vedenie magnetického ventilu sa smie vŕahovať len od magnetického ventilového bloku v smere k prijímaču.
- ZH** 电磁阀导线用穿电线机穿到空管(EN20)里面。
电磁阀导线只能从电磁阀组向接收器方向拉。
- RU** С помощью устройства ввода кабеля введите линию электромагнитного клапана в пустотелую трубу (EN 20).
Линия электромагнитного клапана может вводиться только от блока электромагнитного клапана в направлении приемника.
- HU** A mágnesszelep vezetékét egy kábelbehúzó készülék segítségével húzza be az üres csőbe (EN 20).
A mágnesszelep vezetékét csak a mágnesszelep egységtől a vevő irányába lehet behúzni.
- FI** Vedä magneettiventtiilijohsto suojaPUTken (EN 20) sisään kaapelinsisäänvetolaitteen avulla.
Magneettiventtiilijohdon voi vetää sisään vain magneettiventtiilistä vastaanottimen suuntaan.
- SV** Drag in magnetventilkabeln i det ihåliga kabelröret med hjälp av kabeldragnings-verktyg.
Magnetventilkabeln bar dras in i riktning mottagare från magnetventilblocket.
- LT** Į tuščią vamzdį (EN 20), pasinaudojant kabelio įtraukimo prietaisu, įtraukti magnetinių vožtuvų kabelį.
Magnetinių vožtuvų kabelį galima traukti tik nuo magnetinių vožtuvų į imtuvo pusę.
- HR** Vod magnetskog ventila s pomoću pomagala za uvlačenje kabla uvući u praznu cijev (EN 20).
Vod magnetskog ventila se može uvući samo od bloka magnetskih ventila u smjeru ka prijemniku.
- TR** Manyetik valf hattını bir kablo içeri çekme cihazı ile boş boruya (EN 20) geçirin.
Manyetik valf hattı, sadece manyetik valf bloğu tarafından alıcı yönünde içeri çekilebilir.
- RO** Introduceți cablul supapei magnetice în tubul gol (EN 20) cu ajutorul unui aparat de introdus cabluri.
Cablul supapei magnetice poate fi introdus numai dinspre blocul de supapă magnetică înspre receptor.
- EL** Εισάγετε το καλώδιο της μαγνητικής βαλβίδας με τη βοήθεια μίας συσκευής εισαγωγής καλωδίων στον κενό αγωγό καλωδίων (EN 20). Το καλώδιο μαγνητικής βαλβίδας μπορεί να εισαχθεί μόνο από το συγκρότημα των μαγνητικών βαλβίδων προς την κατεύθυνση του δέκτη.
- SL** Vodnik magnetnega ventila potegnite v prazno cev (EN 20) s pomočjo predvleke za uvlek kablov.
Vodnik magnetnega ventila se lahko uvleče le od bloka magnetnih ventilov v smeri sprejemnika.
- ET** Tõmmake magnetventiili juhe vastava abivahendiga toruüüzi (EN 20).
Magnetventiili juhtme võib tõmmata ainult magnetventiili plokist vastunõija suunas.
- LV** Magnēta ventīļa vadu ar kabeļu ievilcēja palīdzību ievilkst tukšajā caurulē (EN 20).
Magnēta ventīļa vadu iespējams ievilkst tikai no magnēta ventīļa bloka, uztvērēja virzienā.
- SR** Vod magnetskog ventila pomoću pomagala za uvlačenje kabla uvući u praznu cev (EN 20).
Vod magnetskog ventila se može uvlačiti samo od bloka magnetskih ventila u smeru ka prijemniku.
- NO** Magnetventil-ledningen trekkes inn i tomrøret (EN 20) ved hjelp av en ledningstrekker.
Magnetventil-ledningen kan kun trekkes inn fra magnetventilblokken i retning til mottakeren
- BG** Прокарайте кабела на магнитните вентили с помощта на уред за прокаране на кабели в канала за полагање на кабели (EN 20).
Кабелът на магнитните вентили може да се прокара от блока на магнитните вентили по посока на приемника.
- SQ** Futni kabllon e valvulave elektromagnetike brenda tubit të shtrimit (EN 20) me ndihmën e një mjeti për futjen e kablllove.
Kabllloja e valvulave elektromagnetike mund të tërhiqet vetëm nga blloku i valvulave elektromagnetike në drejtim të marrësit.
- AR** يجب إدخال أنابيب صمام المغناطيس داخل الأنبوب الفارغ (EN 20) بمساعدة جهاز إدخال الكابلات.
يمكن إدخال أنابيب صمام المغناطيس من صمام المغناطيس في اتجاه جهاز الاستقبال.

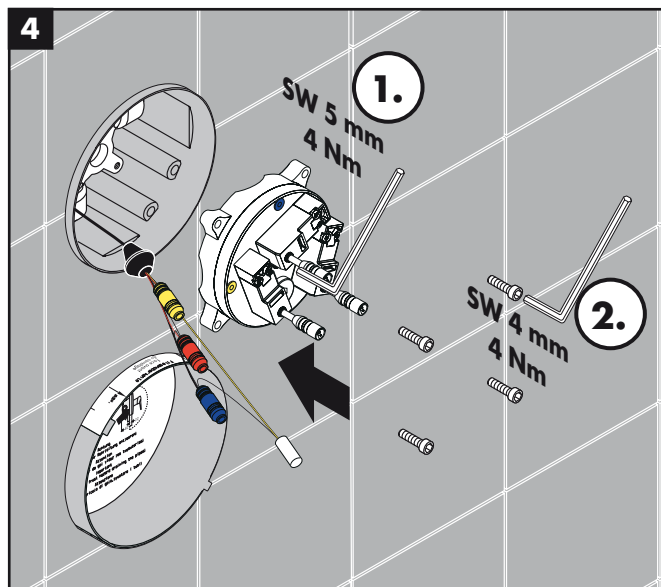

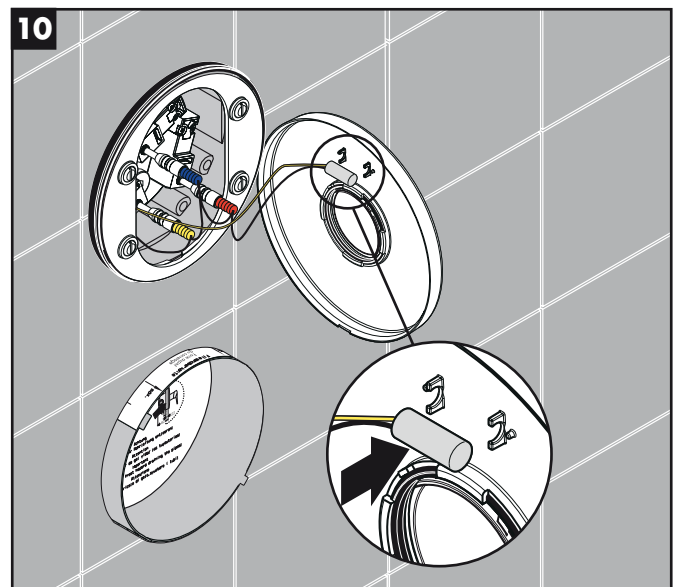
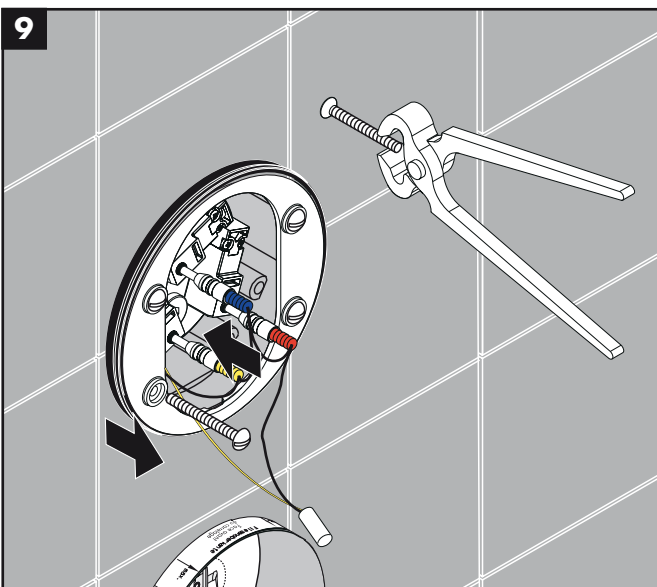
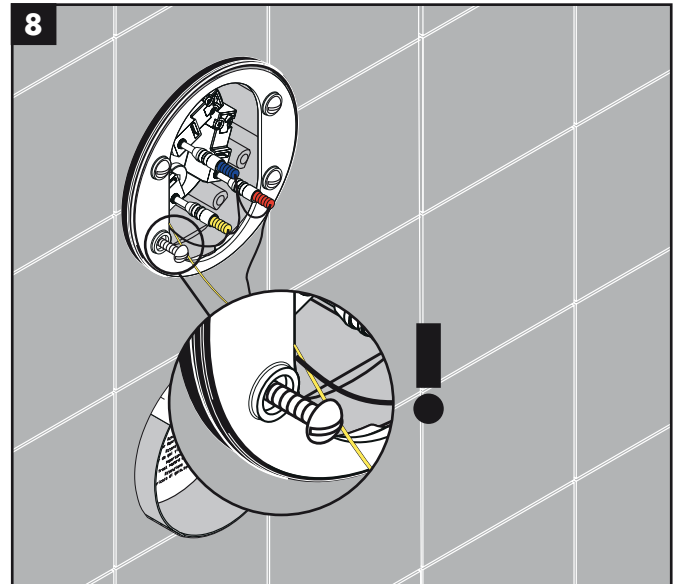
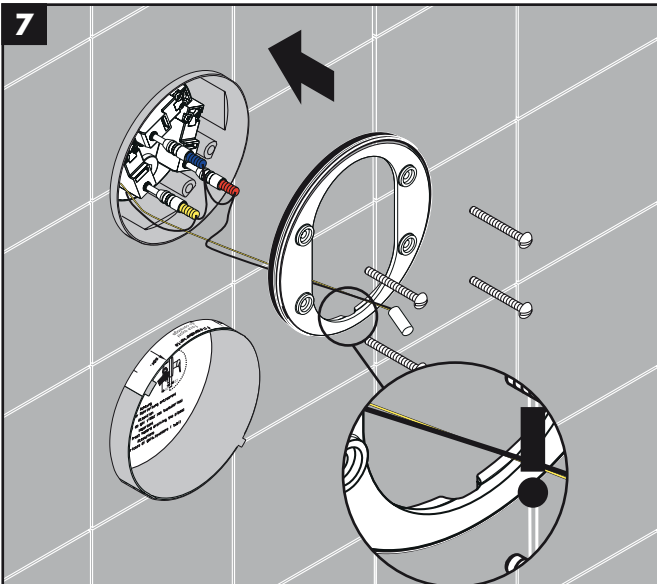
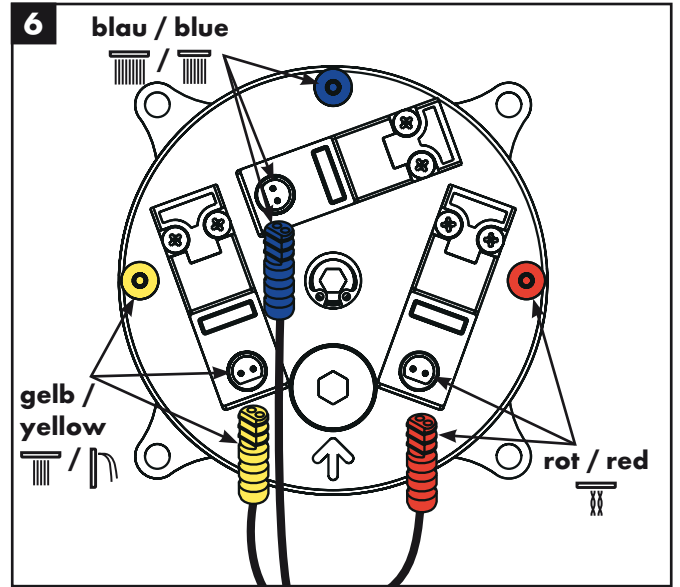
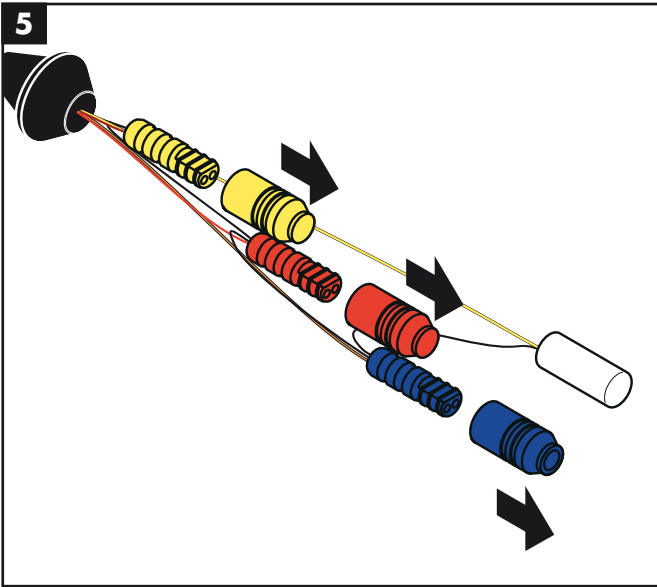
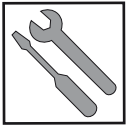

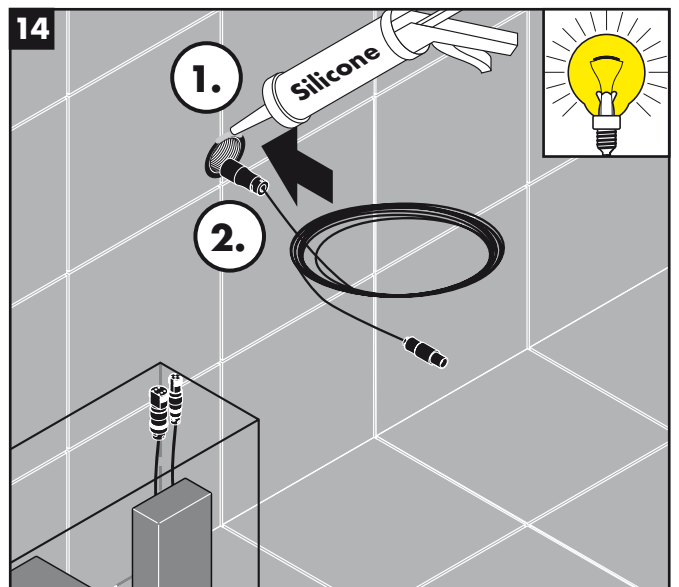
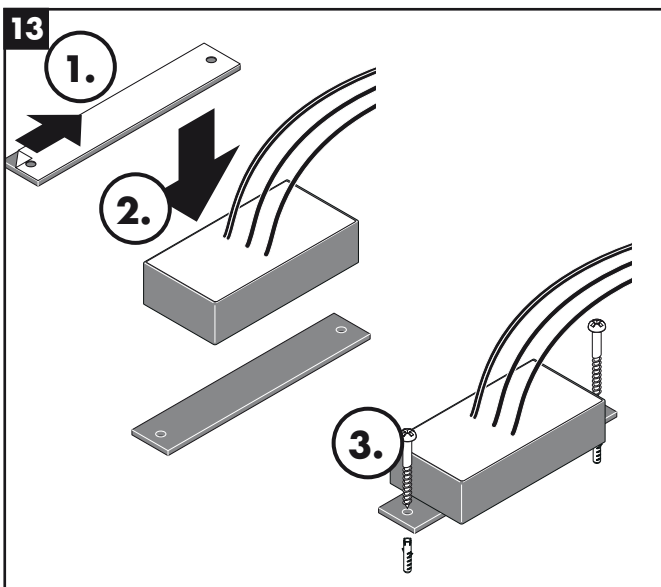
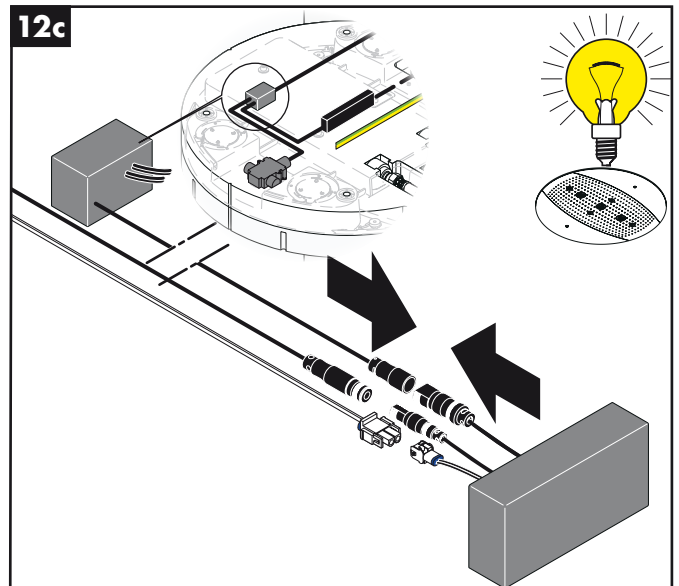
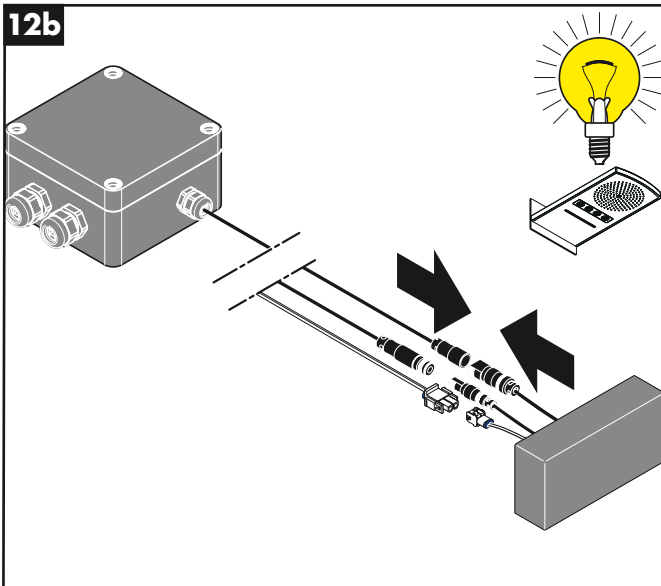
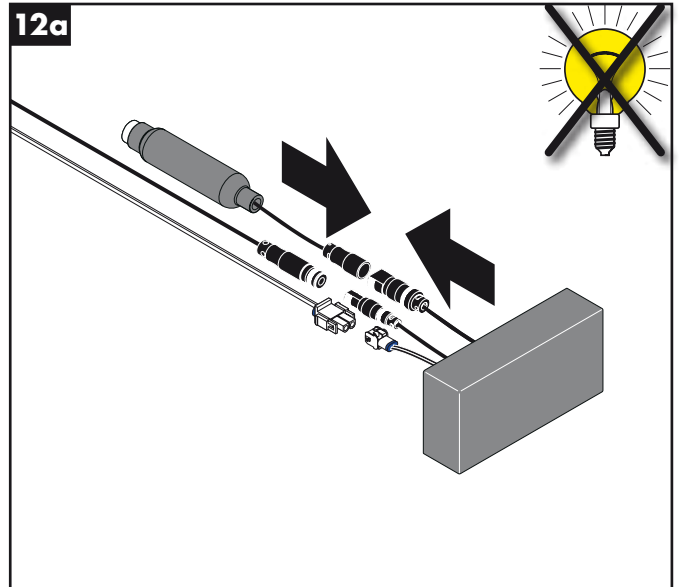
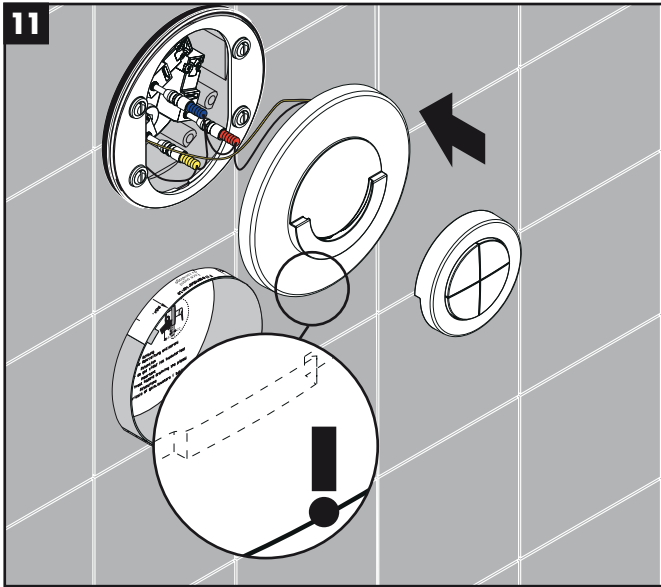
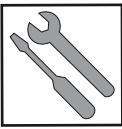

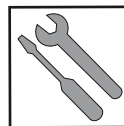

- DE** Lichtleitung mit Hilfe eines Kabeleinzuggerätes in das Leerrohr (EN 20) einziehen. Die Lichtleitung sollte vorzugsweise vom Empfänger in Richtung Duscheinrichtung eingezogen werden.
- FR** A l'aide d'un tire-fil, passer le câble de lampes dans la gaine supplémentaire (EN 20). Passer le câble de lampes de préférence en partant du récepteur vers l'installation de douche.
- EN** Pull the light cable into the empty pipe by means of a cable puller (EN 20). The light cable should preferably be retracted from the receiver in the direction of the shower system.
- IT** Tirare il cavo della luce nel tubo vuoto (EN 20) con l'aiuto di un attrezzo tira-cavo. Il cavo della luce preferibilmente deve essere tirato dal ricevitore in direzione del dispositivo doccia.
- ES** Introducir el cable de iluminación con ayuda de un dispositivo para tracción de cables en el tubo vacío (EN 20). El cable de iluminación, preferentemente se introduce en el lado del emisor tirando en la dirección de la ducha.
- NL** Verlichtingsleiding met behulp van een kabeltrektoestel in de lege buis (EN 20) trekken. De verlichtingsleiding moet bij voorkeur van de ontvanger in de richting van de douche-inrichting getrokken worden.
- DK** Træk lysledningen ind i det tomme rør (EN 20) ved hjælp af en kabeltrækker. Lysledningen bør fortrinsvis trækkes ind fra modtageren i retning af bruderen.
- PT** Inserir o cabo da iluminação com a respectiva ferramenta no tubo vazio (EN 20). Preferencialmente deve-se inserir o cabo de iluminação a partir do receptor no sentido do duche.
- PL** Wciągnąć przewód światłowodowy za pomocą urządzenia do wciągania kabli do rurki kablowej (EN 20). Światłowód powinien w miarę możliwości zostać wciągnięty w kierunku od odbiornika do prysznicza.
- CS** Světelné vedení zaveďte pomocí závaděcího nástroje do ochranné trubky (EN 20). Světelné vedení by mělo být přednostně zaváděno od přijímače ve směru k zařízení sprchy.
- SK** Vsúňte svetelné vedenie s pomocou nástroja na vŕahovanie káblov do ochrannej trubky (EN 20). Svetelné vedenie by ste mali vŕahovať od prijímača smerom k sprchovému zariadeniu.
- ZH** 照明用电源线用穿电线机穿到空管(EN20)里面。照明用电源线尽量从接收器向淋浴装置方向拉。
- RU** С помощью устройства ввода кабеля введите линию освещения в пустотелую трубу (EN 20). Линию освещения рекомендуется вводить от приемника в направлении душевого оборудования.
- HU** A lámpa vezetékét egy kábelbehúzó készülék segítségével húzza be az üres csőbe (EN 20). A lámpa vezetékét ajánlott a vevőtől a zuhanyberendezés irányába behúzni.
- FI** Vedä valojohto suojausputken (EN 20) sisään kaapelinsisäänvetolaitteen avulla. Valojohto tulisi vetää sisään pääasiassa lähettimeltä puolelta suihkulaitteiston suuntaan.
- SV** Dra in ljuskabeln i det ihåliga kabelröret (EN 20) med hjälp av kabeldragnings-verktyg. Ljuskabeln ska helst dras in från mottagaren och mot duschenheten.
- LT** Į tuščią vamzdį (EN 20), pasinaudojant kabelio įtraukimo prietaisu, įtraukii elektros laidus. Elektros laidus reikia tempti nuo imtuvo į dušo įrenginio pusę.
- HR** Svjetlosni vod s pomoću pomagala za uvlačenje kabela uvući u praznu cijev (EN 20). Njega, po mogućnosti, uvlačiti od prijemnika u smjeru dijela za tuširanje.
- TR** Aydınlatma hattını bir kablo içeri çekme cihazı ile boş boruya (EN 20) geçirin. Aydınlatma hattı özellikle alıcı tarafından duş tertibatı yönünde içeri çekilmelidir.
- RO** Introduceți cablul de lumină în tubul gol (EN 20) cu ajutorul unui aparat de introdus cabluri. Cablul de lumină trebuie introdus de preferință dinspre receptor înspre instalația de duș.
- EL** Εισάγετε το καλώδιο φωτισμού με την βοήθεια μίας συσκευής εισαγωγής καλωδίων στον κενό αγωγό καλωδίων (EN 20). Το καλώδιο φωτισμού θα πρέπει κατά προτίμηση να εισαχθεί από τον δέκτη προς την κατεύθυνση του συστήματος ντους.
- SL** Vodnik za luč potegnite v prazno cev (EN 20) s pomočjo predvleke za uvlek kablov. Vodnik za luč je treba po možnosti uvleči od sprejemnika v smeri priprave za prhanje.
- ET** Tõmmake valguskaabel juhe vastava abivahendiga torurüüzi (EN 20). Eelistatud on valguskaabli vedamine vastuvõtjast dušisüsteemi poole.
- LV** Ievilkta gaismas vadu ar kabelu ievilkēja palīdzību tukšajā caurulē (EN 20). Gaismas vadam vajadzētu būt ievilktam no uztvērēja, dušas iekārtas virzienā.
- SR** Svetlosni vod pomoću pomagala za uvlačenje kabla uvući u praznu cev (EN 20). Njega, po mogućstvu, treba uvlačiti od prijemnika u smeru dela za tuširanje.
- NO** Lysledningen trekkes inn i tomrør (EN 20) ved hjelp av en ledningstrekker. Det anbefales å trekke lysledningen inn fra mottakeren og i retning til dusjanlegget.
- BG** Прокарайте светлинния кабел с помощта на уред за прокаране на кабели в канала за полагане на кабели (EN 20). За предпочитане е светлинният кабел да се прокара от приемника по посока на устройството за душа.
- SQ** Futni kabllon e dritës brenda tubit të shtrimit (EN 20) me ndihmën e një mjeti për futjen e kabllave. Kabllloja e dritës duhet që të tërhiqet nga marrësi në drejtim të pajisjes së dushit.
- AR** يجب إدخال أبيل الإضاءة في الأنبوب الفارغ (EN20) بمساعدة جهاز إدخال أبيل. يفضل إدخال الكابل الضوئي من جهاز الاستقبال في اتجاه وحدة الدش.

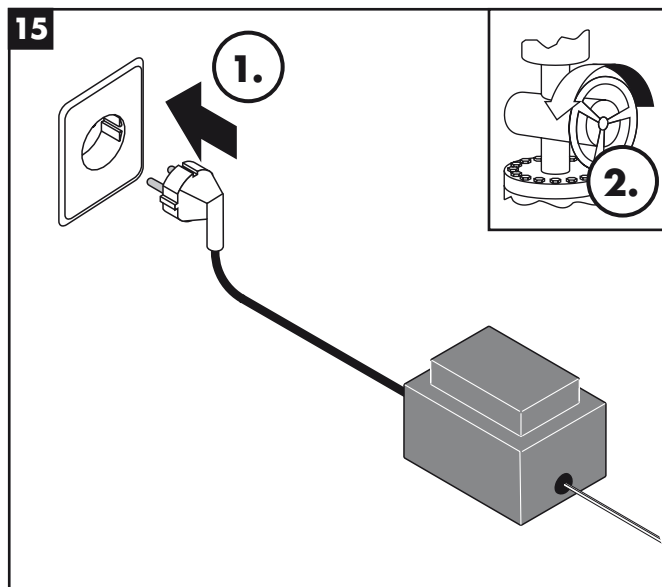

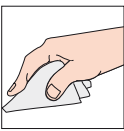

Reinigung Schmutzfangsieb

Nettoyage filter

Cleaning filter

Pulitura filtro

Limpiair filtro

Reinigen zeefje

Rengøring snavsfilter

Limpeza filtro

Czyszczenie sitko

Čištění filtrační sitko

Čištění filtrační sitko

清洗 过滤网

Очистка Улавливающий фильтр

Tisztítás szűrőt tisztítani

Puhdistus likasihti

Rengöring filter

Valymas filtras

Čišćenje rešetkasti filter

Temizleme filtre

Curățare sită de impurități

Καθαρισμός Φίλτρο συλλογής

ακαθαρσιών

Čišćenje Filtrirna mrežica

Puhastamine filter

Триšana филтрс

Čišćenje Mrežica za hvatanje za prljavštine

Rengjøring smussfiltersil

Почистване Цедка за улавяне на замърсявания

Pastrimi sitë për mbledhjen e rapastërtive

التنظيف مرشح الاتساخات

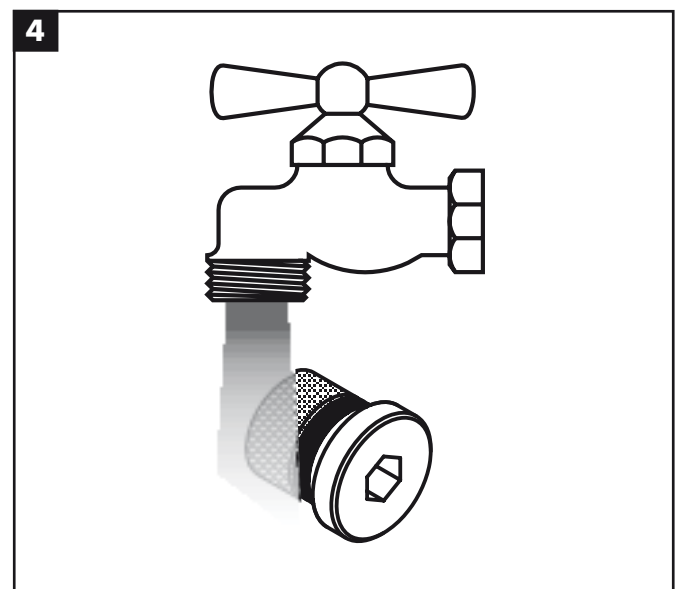
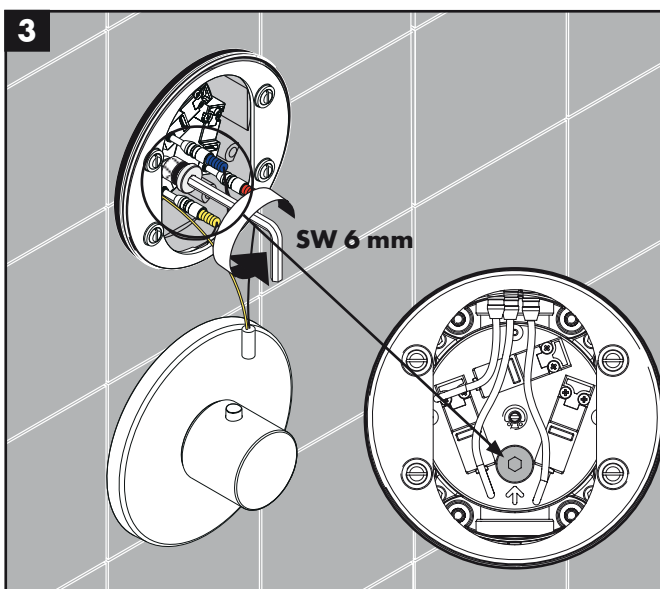
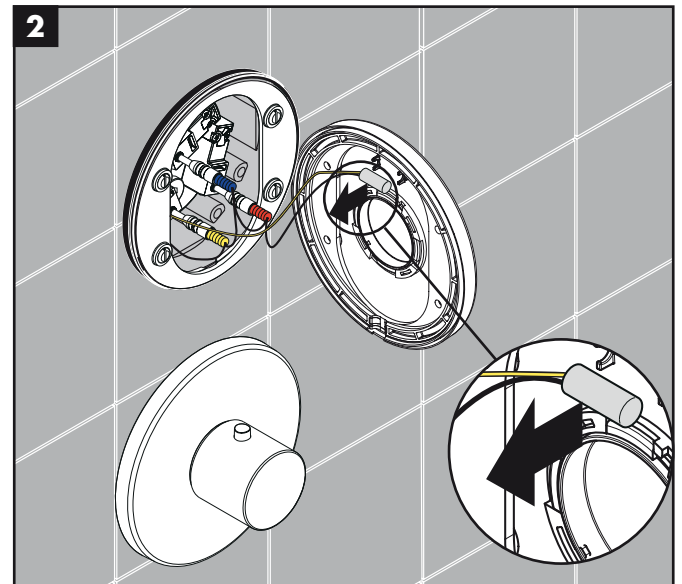
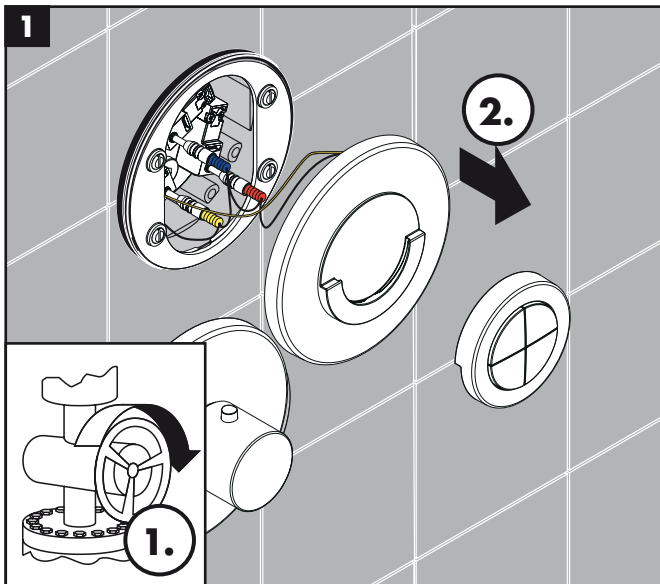

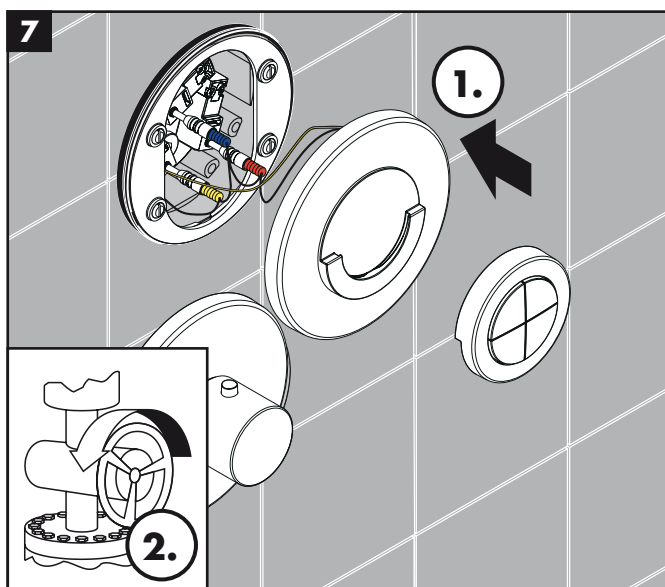
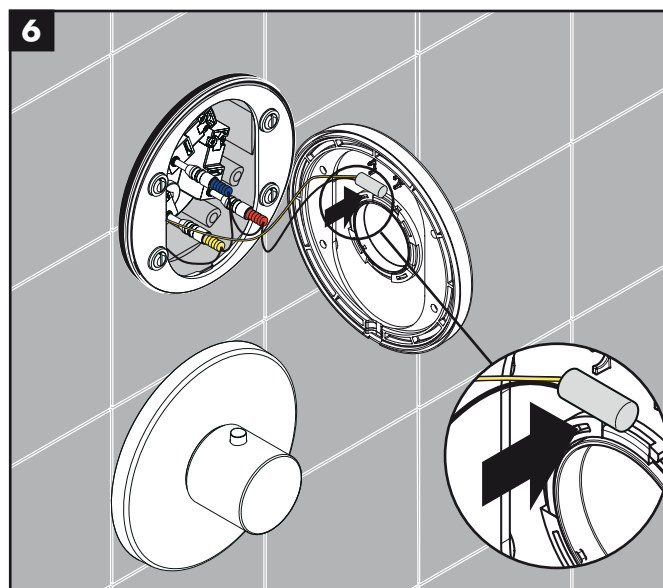
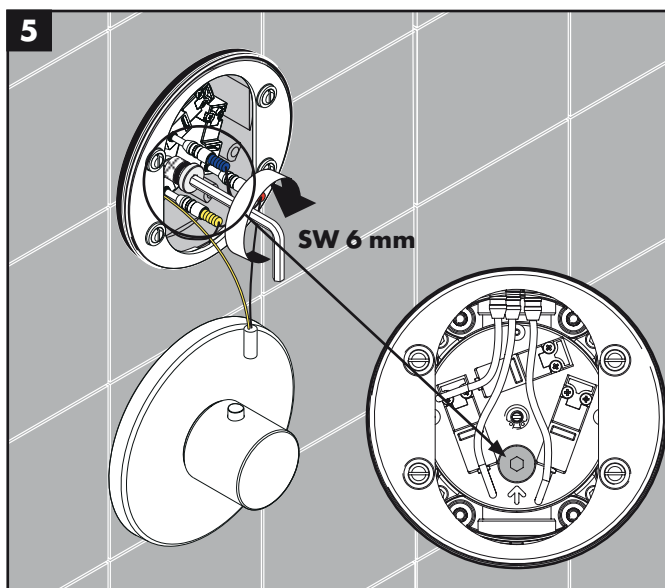
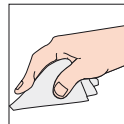

Ersatzteile
Pièces de rechange
Spare parts
Ricambi
Piezas de recambio
Reserveonderdelen
Reservebele
Peças sobressalentes
Części zamienne
Náhradní díly

Náhradné diely
备件
Запасные части
Alkatrészek
Varaosat
Atsarginės dalys
Atsarginės dalys
Rezervni dijelovi
Yedek parçalar
Piese de schimb

Ανταλλακτικά
Nadomestni deli
Varuosad
Rezerves daļas
Rezervni delovi
Reservedeler
Резервни части
Рјесѐт е кѐмбимит
قطعة غيار

iControl mobile
 15942000 / 15943000

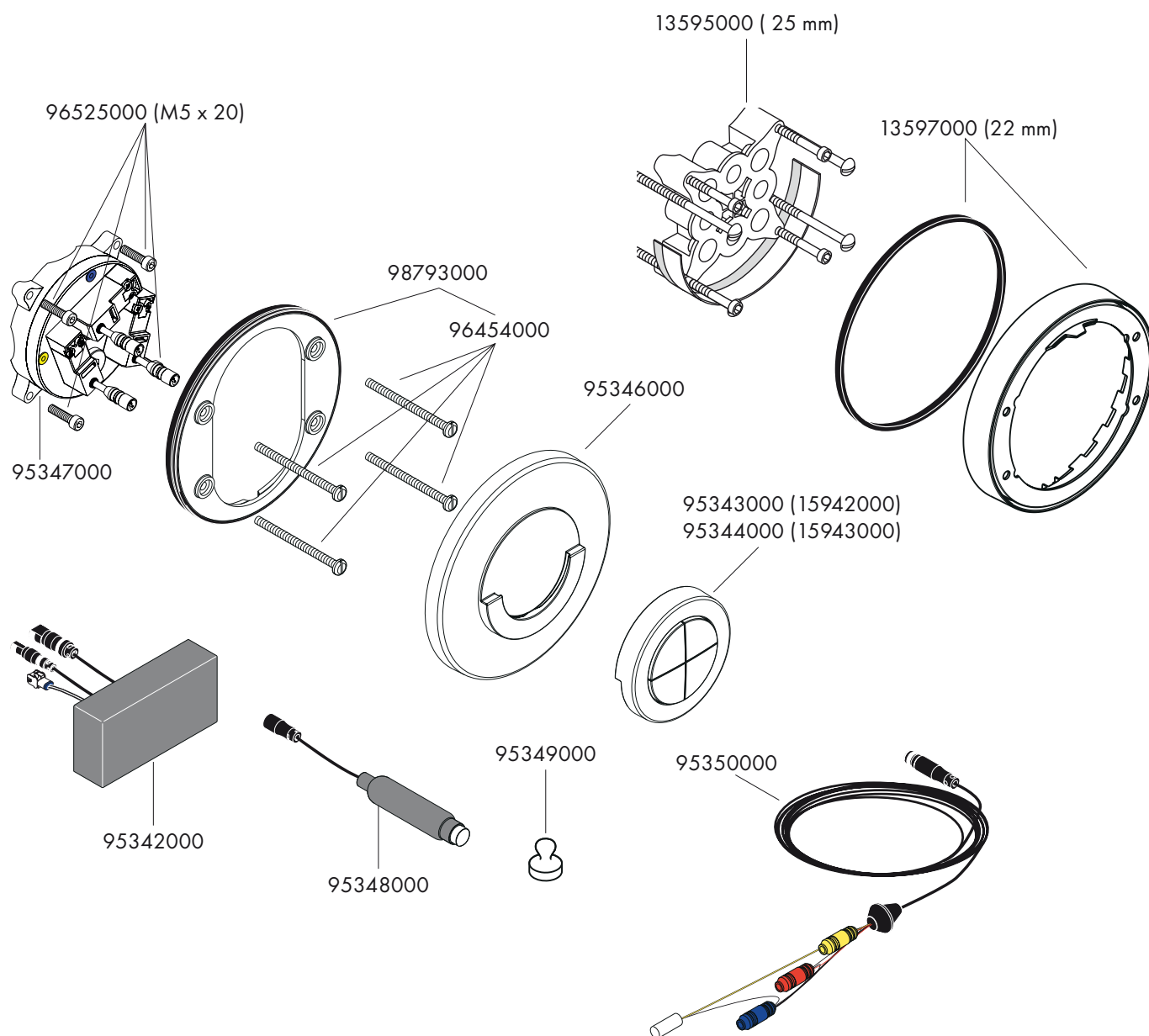

iControl mobile
15944000 / 15945000

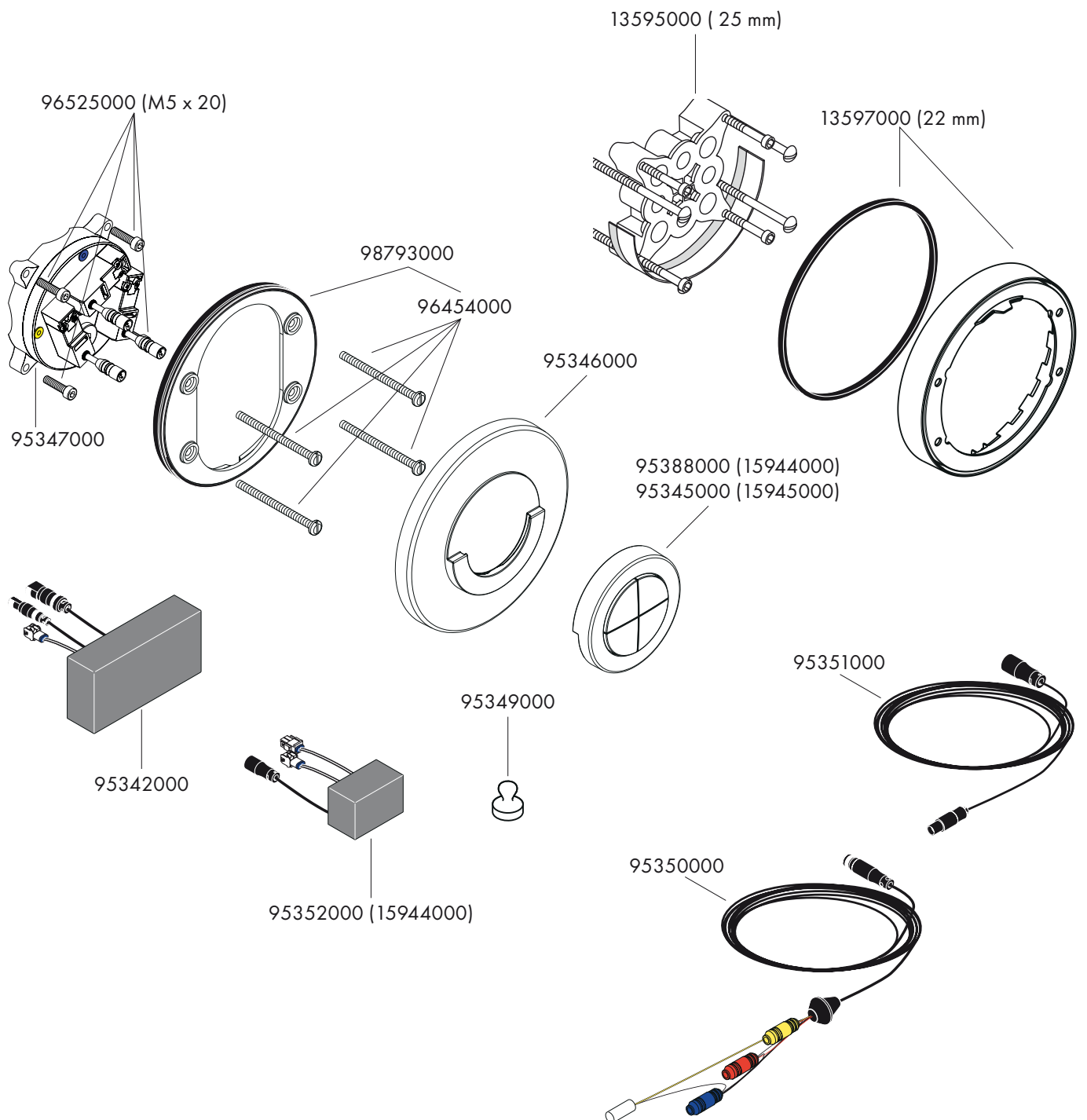

hansgrohe

Hansgrohe · Postfach 1145 · D-77761 Schiltach · Telefon +49 (0) 78 36/51-1282 · Telefax +49 (0) 7836/511440
E-Mail: info@hansgrohe.com · Internet: www.hansgrohe.com

04/2011
9.04538.01