

# AXOR®

hansgrohe

|           |   |           |
|-----------|---|-----------|
| <b>DE</b> | Gebrauchsanleitung / Montageanleitung                 | <b>2</b>  |
| <b>FR</b> | Mode d'emploi / Instructions de montage               | <b>3</b>  |
| <b>EN</b> | Instructions for use / assembly instructions          | <b>4</b>  |
| <b>IT</b> | Istruzioni per l'uso / Istruzioni per l'installazione | <b>5</b>  |
| <b>ES</b> | Modo de empleo / Instrucciones de montaje             | <b>6</b>  |
| <b>NL</b> | Gebruiksaanwijzing / Handleiding                      | <b>7</b>  |
| <b>DK</b> | Brugsanvisning / Monteringsvejledning                 | <b>8</b>  |
| <b>PT</b> | Instruções para uso / Manual de instalação            | <b>9</b>  |
| <b>PL</b> | Instrukcja obsługi / Instrukcja montażu               | <b>10</b> |
| <b>CS</b> | Návod k použití / Montážní návod                      | <b>11</b> |
| <b>SK</b> | Návod na použitie / Montážny návod                    | <b>12</b> |
| <b>ZH</b> | 用户手册 / 组装说明   | <b>13</b> |
| <b>RU</b> | Руководство пользователя / Инструкция по монтажу      | <b>14</b> |
| <b>HU</b> | Használati útmutató / Szerelési útmutató              | <b>15</b> |
| <b>FI</b> | Käyttöohje / Asennusohje                              | <b>16</b> |
| <b>SV</b> | Bruksanvisning / Monteringsanvisning                  | <b>17</b> |
| <b>LT</b> | Vartotojo instrukcija / Montavimo instrukcijos        | <b>18</b> |
| <b>HR</b> | Upute za uporabu / Uputstva za instalaciju            | <b>19</b> |
| <b>TR</b> | Kullanım kılavuzu / Montaj kılavuzu                   | <b>20</b> |
| <b>RO</b> | Manual de utilizare / Instrucțiuni de montare         | <b>21</b> |
| <b>EL</b> | Οδηγίες χρήσης / Οδηγία συναρμολόγησης                | <b>22</b> |
| <b>SL</b> | Navodilo za uporabo / Navodila za montažo             | <b>23</b> |
| <b>ET</b> | Kasutusjuhend / Paigaldusjuhend                       | <b>24</b> |
| <b>LV</b> | Lietošanas pamācība / Montāžas instrukcija            | <b>25</b> |
| <b>SR</b> | Uputstvo za upotrebu / Uputstvo za montažu            | <b>26</b> |
| <b>NO</b> | Bruksanvisning / Montasjeveiledning                   | <b>27</b> |
| <b>BG</b> | Инструкция за употреба / Инструкция за употреба       | <b>28</b> |
| <b>SQ</b> | Udhëzuesi i përdorimit / Udhëzime rreth montimit      | <b>29</b> |
| <b>AR</b> | دليل الاستخدام / تعليمات التجميع                      | <b>30</b> |

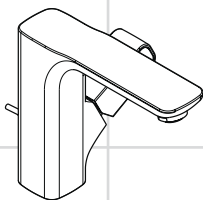

**Urquiola**

11020000 / 11021000 /  
11022000 / 11025000

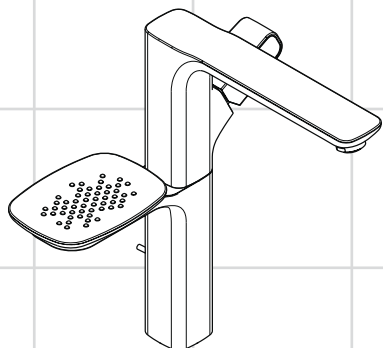

**Urquiola**

11023000 / 11034000

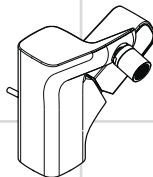

**Urquiola**

11220000



## Sicherheitshinweise

- ⚠ Bei der Montage müssen zur Vermeidung von Quetsch- und Schnittverletzungen Handschuhe getragen werden.
- ⚠ Das Produkt darf nur zu Bade-, Hygiene- und Körperreinigungszwecken eingesetzt werden.
- ⚠ Große Druckunterschiede zwischen den Kalt- und Warmwasseranschlüssen müssen ausgeglichen werden.

## Montagehinweise

- Die Armatur muss nach den gültigen Normen montiert, gespült und geprüft werden.
- Bei Problemen mit dem Durchlauferhitzer oder wenn mehr Wasserdurchsatz gewünscht wird, kann der EcoSmart® (Durchflussbegrenzer), der hinter dem Luftsprudler sitzt entfernt werden.

## Technische Daten

**Armatur serienmäßig mit EcoSmart®** (Durchflussbegrenzer)

|                                  |               |
|----------------------------------|---------------|
| Betriebsdruck:                   | max. 1 MPa    |
| Empfohlener Betriebsdruck:       | 0,1 - 0,5 MPa |
| Prüfdruck:                       | 1,6 MPa       |
| (1 MPa = 10 bar = 147 PSI)       |               |
| Heißwassertemperatur:            | max. 80 °C    |
| Empfohlene Heißwassertemperatur: | 65 °C         |

Hansgrohe Armaturen können in Verbindung mit hydraulisch und thermisch gesteuerten Durchlauferhitzern eingesetzt werden wenn der Fließdruck mindestens 0,15 MPa beträgt.

## Symbolerklärung



Einhandmischer mit Warmwasserbegrenzung, Justierung siehe Seite 33. In Verbindung mit Durchlauferhitzern ist eine Warmwassersperre nicht notwendig.



Kein essigsäurehaltiges Silikon verwenden!



**Maße** (siehe Seite 34 + 35)



**Durchflussdiagramm**  
(siehe Seite 34 + 35)

- ① mit EcoSmart®
- ② ohne EcoSmart®



**Serviceteile** (siehe Seite 37)



**Sonderzubehör**

Montageschlüssel (58085000) nicht im Lieferumfang enthalten



Installationskit nicht im Lieferumfang enthalten



**Bedienung** (siehe Seite 36)



**Reinigung** (siehe beiliegende Broschüre)





**Prüfzeichen** (siehe Seite 38)



**Montage siehe Seite 31 + 32**



## Consignes de sécurité

-  Lors du montage, porter des gants de protection pour éviter toute blessure par écrasement ou coupure
-  Le système de douche ne doit servir qu'à se laver et à assurer l'hygiène corporelle.
-  Il est conseillé d'équilibrer les pressions de l'eau chaude et froide.

## Instructions pour le montage

- La robinetterie doit être installée, rincée et contrôlée conformément aux normes valables.
- En cas de problèmes avec le chauffe-eau, ou bien si le débit d'eau doit être plus important, il est possible d'enlever l'EcoSmart® (limiteur de débit) se trouvant derrière l'aérateur.

## Informations techniques

### Robinetterie équipée en série d'un EcoSmart® (limiteur de débit)

|   |               |
|---|---------------|
| Pression de service autorisée:                              | max. 1 MPa    |
| Pression de service conseillée:                             | 0,1 – 0,5 MPa |
| Pression maximum de contrôle:<br>(1 MPa = 10 bar = 147 PSI) | 1,6 MPa       |
| Température d'eau chaude:                                   | max. 80 °C    |
| Température recommandée:                                    | 65 °C         |

Les mitigeurs Hansgrohe fonctionnent également en association à des chauffe-eau à commande hydraulique ou thermique à condition que la pression soit au minimum de 0,15 MPa.

## Description du symbole



Mitigeur avec limitation de la température: consulter la page 33 pour le réglage.  
Une limitation de la température n'est pas nécessaire quand le mitigeur est alimenté par un chauffe-eau instantané.



Ne pas utiliser de silicone contenant de l'acide acétique!



**Dimensions** (voir page 34 + 35)



**Diagramme du débit**  
(voir page 34 + 35)

- ① avec EcoSmart®
- ② sans EcoSmart®



**Pièces détachées** (voir pages 37)



**Special accessories**

clé de montage (58085000) ne fait pas partie de la fourniture



Mastic d'installation ne fait pas partie de la fourniture



**Instructions de service** (voir page 36)



**Nettoyage** (voir la brochure jointe)





**Classification acoustique et débit** (voir page 38)



**Montage voir page 31 + 32**



## Safety Notes

-  Gloves should be worn during installation to prevent crushing and cutting injuries.
-  The shower system may only be used for bathing, hygienic and body cleansing purposes.
-  The hot and cold supplies must be of equal pressures.

## Installation Instructions

- The fitting must be installed, flushed and tested after the valid norms.
- If the instantaneous water heater causes problems or if you wish to increase the water flow, the EcoSmart® (flow limiter) located behind the aerator can be removed.

## Technical Data

**This mixer series-produced with EcoSmart®** (flow limiter)

|                                 |               |
|---------------------------------|---------------|
| Operating pressure:             | max. 1 MPa    |
| Recommended operating pressure: | 0,1 – 0,5 MPa |
| Test pressure:                  | 1,6 MPa       |
| (1 MPa = 10 bar = 147 PSI)      |               |
| Hot water temperature:          | max. 80 °C    |
| Recommended hot water temp.:    | 65 °C         |

Hansgrohe mixers can be used together with hydraulically and thermally controlled continuous flow heaters if the flow pressure is at least 0,15 MPa.

## Symbol description



To adjust the hot water limiter on single lever mixers, please see page 33. No adjustment is necessary when using a continuous flow water heater.



Do not use silicone containing acetic acid!



## Dimensions

 (see page 34 + 35)

## Flow diagram

 (see page 34 + 35)

- ① with EcoSmart®
- ② without EcoSmart®



## Spare parts

 (see page 37)

## Special accessories

special tool (58085000) order as an extra



Installation kit order as an extra



## Operation

 (see page 36)

## Cleaning

 (see enclosed brochure)





## Test certificate

 (see page 38)

## Assembly see page 31 + 32



## **Indicazioni sulla sicurezza**

-  Durante il montaggio, per evitare ferite da schiacciamento e da taglio bisogna indossare guanti protettivi.
-  Il sistema doccia deve essere utilizzato esclusivamente per l'igiene del corpo.
-  Attenzione! Compensare le differenze di pressione tra i collegamenti dell'acqua fredda e dell'acqua calda.

## **Istruzioni per il montaggio**

- La rubinetteria deve essere installata, pulita e testata secondo le istruzioni riportate!
- Nel caso di problemi con lo scaldacqua oppure nel caso si desiderasse più erogazione, si può eliminare il EcoSmart® (limitatore di flusso) che si trova dietro la valvola di aerazione.

## **Dati tecnici**

**Questo miscelatore è dotato di serie del EcoSmart® (limitatore di flusso)**

|                                     |               |
|-------------------------------------|---------------|
| Pressione d'uso:                    | max. 1 MPa    |
| Pressione d'uso consigliata:        | 0,1 - 0,5 MPa |
| Pressione di prova:                 | 1,6 MPa       |
| (1 MPa = 10 bar = 147 PSI)          |               |
| Temperatura dell'acqua calda:       | max. 80 °C    |
| Temp. dell'acqua calda consigliata: | 65 °C         |

I miscelatori Hansgrohe possono venire usati con caldaie a "bassa pressione" se la pressione di flusso è almeno di 0,15 MPa.

## **Descrizione simbolo**



Regolazione del limitatore di erogazione di acqua calda dei miscelatori monocomando, vedere pagina 33. In combinazione con le caldaie istantanee, il limitatore di erogazione di acqua calda non è necessario.



Non utilizzare silicone contenente acido acetico!



**Ingombri** (vedi pagg. 34 + 35)



**Diagramma flusso**  
(vedi pagg. 34 + 35)

- ① con EcoSmart®
- ② senza EcoSmart®



**Parti di ricambio** (vedi pagg. 37)



**Accessori speciali**

chiave per montaggio (58085000) non contenuto nel volume di fornitura



Mastice d'installazione non contenuto nel volume di fornitura



**Procedura** (vedi pagg. 36)



**Pulitura** (vedi il prospetto accluso)





**Segno di verifica** (vedi pagg. 38)



**Montaggio vedi pagg. 31 + 32**



## Indicaciones de seguridad

-  Durante el montaje deben utilizarse guantes para evitar heridas por aplastamiento o corte.
-  La grifería solo debe ser utilizada para fines de baño, higiene y limpieza corporal.
-  Grandes diferencias de presión en servicio entre agua fría y agua caliente deben equilibrarse.

## Indicaciones para el montaje

- El grifo tiene que ser instalado, probado y testado, según las normas en vigor.
- En caso de problemas con el calentador instantáneo o cuando se desee más caudal de agua puede quitarse el EcoSmart® (limitador de caudal), situado detrás del aireador.

## Datos técnicos

### Grifo, desde fábrica equipado con EcoSmart® (limitador de caudal)

|                                      |               |
|--------------------------------------|---------------|
| Presión en servicio:                 | max. 1 MPa    |
| Presión recomendada en servicio:     | 0,1 – 0,5 MPa |
| Presión de prueba:                   | 1,6 MPa       |
| (1 MPa = 10 bar = 147 PSI)           |               |
| Temperatura del agua caliente:       | max. 80 °C    |
| Temp. recomendada del agua caliente: | 65 °C         |

Los mezcladores Hansgrohe pueden ser utilizados junto con calentadores continuos de agua que sean manejados de manera hidráulica o térmica, siempre que la presión en servicio ascienda a un mínimo de 0,15 MPa.

## Descripción de símbolos



Uso como mezclador monomando con limitación del caudal de agua caliente: ver ajuste en página 33. En combinación con calentadores instantáneos no es necesario limitar el caudal de agua caliente.



No utilizar silicona que contiene ácido acético!



**Dimensiones** (ver página 34 + 35)



**Diagrama de circulación** (ver página 34 + 35)

- ① con EcoSmart®
- ② sin EcoSmart®



**Repuestos** (ver página 37)



**Opcional**

Llave de montaje (58085000) no incluido en el suministro



Masilla no incluido en el suministro



**Manejo** (ver página 36)



**Limpiar** (ver el folleto adjunto)



**Marca de verificación** (ver página 38)



**Montaje ver página 31 + 32**



## Veiligheidsinstructies

- ⚠ Bij de montage moeten ter voorkoming van knel- en snijwonden handschoenen worden gedragen.
- ⚠ Het douchesysteem mag alleen voor het wassen, hygiënische doeleinden en voor de lichaamreiniging worden gebruikt.
- ⚠ Grote drukverschillen tussen de kouden warm wateraansluitingen dienen vermeden te worden.

## Montage-instructies

- Leidingen doorspoelen volgens Norm. De mengkraan vervolgens monteren en controleren.
- Wanneer problemen optreden bij doorloopgeisers of wanneer een grotere waterdoorvoer gewenst is, kan de EcoSmart® (doorstroombegrenzer) die achter de perlator is gemonteerd, makkelijk verwijderd worden.

## Technische gegevens

**Armatuur standaard met EcoSmart®** (doorstroombegrenzer)

|                              |               |
|------------------------------|---------------|
| Werkdruk: max.               | max. 1 MPa    |
| Aanbevolen werkdruk:         | 0,1 – 0,5 MPa |
| Getest bij:                  | 1,6 MPa       |
| (1 MPa = 10 bar = 147 PSI)   |               |
| Temperatuur warm water:      | max. 80 °C    |
| Aanbevolen warm water temp.: | 65 °C         |

Hansgrohe kranen kunnen samen met hydraulisch en thermisch gestuurde geisers gebruikt worden indien de uitstroomdruk min. 0,15 MPa bedraagt.

## Symboolbeschrijving



Eéngreepsmengkranen met warmwaterbegrenzing, instelling zie blz. 33. In combinatie met geisers is een warmwaterbegrenzing niet noodzakelijk.



Gebruik geen zuurhoudende silicone!



**Maten** (zie blz. 34 + 35)



**Doorstroomdiagram**  
(zie blz. 34 + 35)

- ① met EcoSmart®
- ② zonder EcoSmart®



**Service onderdelen** (zie blz. 37)



**Toebehoren**

montagesleutel (58085000) behoort niet tot het leveringspakket



Kit behoort niet tot het leveringspakket



**Bediening** (zie blz. 36)



**Reinigen** (zie bijgevoegde brochure)



**Keurmerk** (zie blz. 38)



**Montage zie blz. 31 + 32**



## Sikkerhedsanvisninger

- △ Ved monteringen skal der bruges handsker for at undgå kvæstelser og snitsår.
- △ Brusersystemet må kun bruges til bade-, hygiejne og rengøringsformål.
- △ Større trykforskelte mellem koldt og varmt vand bør udjævnes.

## Monteringsanvisninger

- Ifølge gældende regler, skal armaturet monteres, skylles igennem og afprøves.
- Ved problemer med gennemløbsvandvarmer eller hvis der ønskes mere vandgennemstrømning, kan EcoSmart® (gennemstrømningsbegrænseren), der sidder i perlatoren, fjernes.

## Tekniske data

**Armaturet er forsynet med EcoSmart®** (gennemstrømningsbegrænsere)

|                                 |               |
|---------------------------------|---------------|
| Driftstryk:                     | max. 1 MPa    |
| Anbefalet driftstryk:           | 0,1 – 0,5 MPa |
| Prøvetryk:                      | 1,6 MPa       |
| (1 MPa = 10 bar = 147 PSI)      |               |
| Varmtvandstemperatur:           | max. 80 °C    |
| Anbefalet varmtvandstemperatur: | 65 °C         |

Hansgrohe armaturer kan anvendes i forbindelse med hydraulisk- og termiskstyrede gennemstrømningsvandvarmere ved et vandtryk på 0,15 MPa.

## Symbolbeskrivelse



Etgrebsarmaturer med varmtvandsbegrænsning, justering se side 33. I forbindelse med gennemstrømningsvandvarmer er en varmtvandsbegrænsning ikke nødvendig.



Der må ikke benyttes eddikesyreholdig silikone!



**Målene** (se s. 34 + 35)



**Gennemstrømningsdiagram**  
(se s. 34 + 35)

- ① med EcoSmart®
- ② uden EcoSmart®



**Reserve dele** (se s. 37)



**Specialtilbehør**

Monteringsnøgle (58085000) ikke med i leveringsomfang



Kitt ikke med i leveringsomfang



**Bediening** (se s. 36)



**Rengøring** (se venligst den vedlagte brochure)





**Godkendelse** (se s. 38)







## Avisos de segurança

-  Durante a montagem devem ser utilizadas luvas de protecção, de modo a evitar ferimentos resultantes de entalamentos e de cortes.
-  O sistema de duche só pode ser utilizado para fins de higiene pessoal.
-  Grandes diferenças entre as pressões das águas quente e fria devem ser compensadas.

## Avisos de montagem

- A misturadora deve ser instalada, purgada e testada de acordo com as normas em vigor.
- Em caso de problemas com o esquentador de água ou se desejar maior débito de água, é possível retirar o EcoSmart® (limitador de caudal), situado por trás do emulsor.

## Dados Técnicos

### Misturadoras produzidas em série com EcoSmart® (limitador de caudal)

|                                |               |
|--------------------------------|---------------|
| Pressão de funcionamento:      | max. 1 MPa    |
| Pressão de func. recomendada:  | 0,1 – 0,5 MPa |
| Pressão testada:               | 1,6 MPa       |
| (1 MPa = 10 bar = 147 PSI)     |               |
| Temperatura da água quente:    | max. 80 °C    |
| Temp. água quente recomendada: | 65 °C         |

As misturadoras Hansgrohe podem ser utilizadas com esquentadores (de controlo térmico ou hidráulico) desde que a pressão de utilização seja, no mínimo, de 0,15 MPa.

## Descrição do símbolo



Misturadora monocomando equipada com limitador de temperatura (vide pág.33). Em combinação com caldeira ou esquentador instantâneo o limitador de água quente não se aplica.



Não utilizar silicone que contenha ácido acético!



**Medidas** (ver página 34 + 35)



**Fluxograma**  
(ver página 34 + 35)

- ① com EcoSmart®
- ② sem EcoSmart®



**Peças de substituição** (ver página 37)



**Acessórios especiais**

Chave especial (58085000) não incluído no volume de fornecimento



Mástique não incluído no volume de fornecimento



**Funcionamento** (ver página 36)



**Limpeza** (consultar a seguinte brochura)





**Marca de controlo** (ver página 38)





## Wskazówki bezpieczeństwa

-  Aby uniknąć zranień, takich jak zgniecenia czy przecięcia, podczas montażu należy nosić rękawice.
-  Pryszyć może być używany tylko do kąpieli, higieny i czyszczenia ciała.
-  Znaczne różnice ciśnień na dopływach ciepłej i zimnej wody muszą zostać wyrównane.

## Wskazówki montażowe

- Armatura musi być zamontowana, przepłukana i wypróbowana według obowiązujących norm.
- W przypadku problemów z przepływowymi podgrzewaczami wody lub jeśli chce się uzyskać większy przepływ wody, można usunąć EcoSmart® (ogranicznik przepływu) znajdujący się za napowietrzaczem.

## Dane techniczne

### Armatura produkowana seryjnie z funkcją EcoSmart® (ogranicznik przepływu)

|                                    |               |
|------------------------------------|---------------|
| Ciśnienie robocze:                 | maks. 1 MPa   |
| Zalecane ciśnienie robocze:        | 0,1 - 0,5 MPa |
| Ciśnienie próbne:                  | 1,6 MPa       |
| (1 MPa = 10 bary = 147 PSI)        |               |
| Temperatura wody gorącej:          | maks. 80 °C   |
| Zalecana temperatura wody gorącej: | 65 °C         |

Armatura Hansgrohe może być stosowana z przepływowymi podgrzewaczami wody sterowanymi hydraulicznie i termicznie w przypadku, gdy ciśnienie przepływu wynosi co najmniej 0,15 MPa.

## Opis symbolu



Mieszacz jednouchwytowy z ogranicznikiem temperatury wody, ustawianie, patrz str. 33. W połączeniu z przepływowym podgrzewaczem wody ogranicznik temperatury wody nie jest konieczny.



Nie stosować silikonów zawierających kwas octowy!



**Wymiary** (patrz strona 34 + 35)



**Schemat przepływu** (patrz strona 34 + 35)

- ① z EcoSmart®
- ② bez EcoSmart®



**Części serwisowe** (patrz strona 37)



**Wyposażenie specjalne**

Klucz montażowy (58085000) Nie jest częścią dostawy



Kit instalatorski Nie jest częścią dostawy



**Obsługa** (patrz strona 36)



**Czyszczenie** (patrz dołączona broszura)



**Znak jakości** (patrz strona 38)



**Montaż patrz strona 31 + 32**



## **Bezpečnostní pokyny**

-  Pro zabránění řezným zraněním a pohmožděninám je nutné při montáži nosit rukavice.
-  Produkt smí být používán pouze ke koupání a za účelem tělesné hygieny.
-  Je nutné vyrovnat velké rozdíly tlaku mezi přípoji studené a teplé vody.

## **Pokyny k montáži**

- Armatura se musí montovat, proplachovat a testovat podle platných norem.
- Při problémech s průtokovým ohřívačem, nebo když je požadován větší průtok, může být odstraněno zařízení EcoSmart® (omezovač průtoku), které je umístěno za perlátorem.

## **Technické údaje**

### **Armatura je sériově vybavena zařízením EcoSmart® (omezovač průtoku)**

|                                |               |
|--------------------------------|---------------|
| Provozní tlak:                 | max. 1 MPa    |
| Doporučený provozní tlak:      | 0,1 – 0,5 MPa |
| Zkušební tlak:                 | 1,6 MPa       |
| (1 MPa = 10 bar = 147 PSI)     |               |
| Teplota horké vody:            | max. 80 °C    |
| Doporučená teplota horké vody: | 65 °C         |

Armatury Hansgrohe je možno používat v kombinaci s hydraulicky a tepelně řízenými průtokovými ohřívači v případě, že tlak činí minimálně 0,15 MPa.

## **Popis symbolů**



Páková baterie s omezením horké vody, seřízení viz. str. 33. Ve spojení s průtokovými ohřívači není uzávěr teplé vody nutný.



Nepoužívat silikon s obsahem kyseliny octové!



**Rozměry** (viz strana 34 + 35)



**Diagram průtoku**  
(viz strana 34 + 35)

- ① se zařízením EcoSmart®
- ② bez zařízením EcoSmart®



**Servisní díly** (viz strana 37)



**Zvláštní příslušenství**

montážní klíč (58085000) není součástí dodávky



Instalační kit není součástí dodávky



**Ovládání** (viz strana 36)



**Čištění** (viz příložená brožura)





**zkušební značka** (viz strana 38)





## Bezpečnostné pokyny

-  Pri montáži musíte nosiť rukavice, aby ste predišli pomliaždeninám a rezným poraneniam.
-  Produkt sa smie používať len na kúpanie a telesnú hygienu.
-  Veľké rozdiely v tlaku medzi prípojkami studenej a teplej vody musia byť vyrovnané.

## Pokyny pre montáž

- Armatúra sa musí montovať, preplachovať a testovať podľa platných noriem.
- Pri problémoch s prietokovým ohrievačom alebo ak je požadovaný väčší prietok vody, môže sa demontovať zariadenie EcoSmart® (obmedzovač prietoku), ktoré je umiestnené za perlátorom.

## Technické údaje

### Armatúra je sériovo vybavená zariadením

**EcoSmart®** (obmedzovač prietoku)

|                                 |               |
|---------------------------------|---------------|
| Prevádzkový tlak:               | max. 1 MPa    |
| Doporučený prevádzkový tlak:    | 0,1 – 0,5 MPa |
| Skúšobný tlak:                  | 1,6 MPa       |
| (1 MPa = 10 bar = 147 PSI)      |               |
| Teplota teplej vody:            | max. 80 °C    |
| Doporučená teplota teplej vody: | 65 °C         |

Batéria Hansgrohe môžete používať v spojení s hydraulickými a tepelne ovládanými prietokovými ohrievačmi, ak je tlak minimálne 0,15 MPa.

## Popis symbolov



Páková batéria s obmedzením teplej vody, nastavenie vid'.str. 33. V spojení s prietokovými ohrievačmi nie je uzáver teplej vody nutný.



Nepoužívať silikón s obsahom kyseliny octovej!



**Rozmery** (vid' strana 34 + 35)



**Diagram prietoku**  
(vid' strana 34 + 35)

- ① so zariadením EcoSmart®
- ② bez zariadenia EcoSmart®



**Servisné diely** (vid' strana 37)



**Zvláštne príslušenstvo**

montážny kľúč (58085000) nie je súčasťou dodávky



Inštalačná súprava nie je súčasťou dodávky



**Obsluha** (vid' strana 36)



**Čistenie** (nájdete v priloženej brožúre)



**Osvedčenie o skúške**  
(vid' strana 38)





## 安全技巧

- △ 装配时为避免挤压和切割受伤，必须戴上手套。
- △ 淋浴系统只允许作为洗浴、卫生和洁身之用。
- △ 冷热水管间过大的压力差必须予以平衡。

## 安装提示

- 必须按照现行的规定安装，冲洗和测试产品。
- 如果使用即热式热水器时出现问题，或要求更大的水流量，可以把位于水波器后面的 EcoSmart（流量限制器）拆除。

## 技术参数

本龙头配有 EcoSmart（流量限制器）

|                            |             |
|----------------------------|-------------|
| 工作压强:                      | 最大 1 MPa    |
| 推荐工作压强:                    | 0,1 0,5 MPa |
| 测试压强:                      | 1,6 MPa     |
| (1 MPa = 10 bar = 147 PSI) |             |
| 热水温度:                      | 最大 80° C    |
| 推荐热水温度:                    | 65° C       |

如果水压达到0,15 MPa以上，汉斯格雅双手柄龙头可以和液压式或热控式连续流热水器一起使用。

## 符号说明



带有热水控制器的单手柄龙头的调节方法，参见第33页。如果与连续流热水器一起使用，则不必作任何调节。



请勿使用含有乙酸的硅！



大小 (参见第34 + 35页)



流量示意图  
(参见第34 + 35页)

- ① 带有 EcoSmart
- ② 无 EcoSmart



备用零件 (参见第 37 页)



选装附件

专用工具 (58085000) 不在供货范围内



水管胶泥 不在供货范围内



操作 (参见第 36 页)



清洗 (附有小手册)





检验标记 (参见第 38 页)



安装 参见第31 + 32页



## Указания по технике безопасности

-  Во время монтажа следует надеть перчатки во избежание прищемления и порезов.
-  Изделие разрешается использовать только в гигиенических целях: для принятия ванны и личной гигиены.
-  донного клапа. Перед установкой смесителя необходимо регулировочными кранами выровнять давление холодной и горячей воды при помощи вентилей регулирующих подачу воды в квартиру.

## Указания по монтажу

- Смеситель должен быть смонтирован по действующим нормам и в соответствии с настоящей инструкцией, проверен на герметичность и безупречность работы.
- Если возникнут проблемы с проточным бойлером или потребуется увеличить расход воды, то можно удалить EcoSmart® (ограничитель потока воды), который установлен за воздушным рассекателем.

## Технические данные

### Смесители этой серии серийно оснащаются

**EcoSmart®** (ограничителем потока воды)

Рабочее давление: не более. 1 МПа

Рекомендуемое рабочее давление: 0,1 – 0,5 МПа

Давление: 1,6 МПа

(1 МПа = 10 bar = 147 PSI)

Температура горячей воды: не более. 80°C

Рекомендуемая темп. гор. воды: 65°C

Арматуры Hansgrohe могут использоваться в комбинации с проточными нагревателями с гидравлическим и термическим управлением, если давление истечения составляет не менее 0,15 МПа.

## Описание символов



Однорычажный смеситель имеет ограничитель расхода горячей воды (см. Стр. 33: юстировка).



Не применяйте силикон, содержащий искусственную кислоту.



**Размеры** (см. стр. 34 + 35)



**Схема потока**  
(см. стр. 34 + 35)

- ① С EcoSmart®
- ② Без EcoSmart®



**Комплект** (см. стр. 37)



**Специальные принадлежности**

Монтажный ключ (58085000) не включено в объем поставки!



Монтаж подводки не включено в объем поставки!



**Эксплуатация** (см. стр. 36)



**Очистка** (см прилагаемая брошюра)





**Знак технического контроля**  
(см. стр. 38)





## Biztonsági utasítások

-  A szerelésnél a zúzódások és vágási sérülések elkerülése érdekében kesztyűt kell viselni.
-  A terméket csak fürdéshez, mosakodáshoz, és egészségügyi tisztálkodáshoz szabad használni.
-  A hidegvíz- és a melegvíz-csatlakozások közötti nagy nyomáskülönbséget kikell egyenlíteni!

## Szerelési utasítások

- A csaptelepet az érvényben lévő előírásoknak megfelelően kell felszerelni, átöblíteni és ellenőrizni.
- Ha problémák adódnak az átfolyós vízmelegítővel vagy nagyobb átfolyó vízmennyiségre van szükség, akkor az EcoSmart® (átfolyáskorlátozó) eltávolítható a perlátor mögül.

## Műszaki adatok

### A csaptelep szériakivitelben el van látva EcoSmart® (átfolyáskorlátozó) berendezéssel

|                                 |               |
|---------------------------------|---------------|
| Üzemi nyomás:                   | max. 1 MPa    |
| Ajánlott üzemi nyomás:          | 0,1 – 0,5 MPa |
| Nyomáspróba:                    | 1,6 MPa       |
| (1 MPa = 10 bar = 147 PSI)      |               |
| Forróvíz hőmérséklet:           | max. 80 °C    |
| Forróvíz javasolt hőmérséklete: | 65 °C         |

A Hansgrohe csaptelepek hidraulikus és termikus vezérlésű átfolyós melegítővel kapcsolatban is használhatóak, ha az átfolyó nyomás legalább 0,15 MPa.

## Szimbólumok leírása



Az egykaros, melegvíz-korlátozóval ellátott keverő csaptelep beállítását lásd a 33. oldalon. Az átfolyó rendszerű vízmelegítőknél nem szükséges a melegvíz-korlátozó.



Ne használjon ecetsavtartalmú szilikon!



**Méretet** (lásd a 34 + 35. oldalon)



**Átfolyási diagramm**  
(lásd a 34 + 35. oldalon)

- ① EcoSmart® berendezéssel
- ② EcoSmart® nélkül



**Tartozékok** (lásd a 37. oldalon)



**Egyéb tartozék**

Szerelőkulcs (58085000) a szállítási egység nem tartalmazza



szaniter szilikon a szállítási egység nem tartalmazza



**Használat** (lásd a 36. oldalon)



**Tisztítás** (lásd a mellékelt brosúrát)



**Vizsgajel** (lásd a 38. oldalon)



**Szerelés lásd a 31 + 32. oldalon**



## Turvallisuusohjeet

- △ Asennuksessa on käytettävä käsineitä puristumien ja viiltojen aiheuttamien tapaturmien estämiseksi.
- △ Suihkujärjestelmää saa käyttää ainoastaan kylpy-, hygienia- ja puhdistustarkoituksiin.
- △ Suuret paine-erot kylmä- ja kuumavesiliitännöiden välillä on tasattava.

## Asennusohjeet

- Kaluste on asennettava, huuhdeltava ja tarkastettava voimassa olevien määräysten mukaisesti.
- Jos läpivirtauskuumentimen kanssa on ongelmia tai jos halutaan suurempaa veden virtausmäärää, voidaan poreenmuodostajan takana oleva EcoSmart® (virtauksenrajoitin) poistaa.

## Tekniset tiedot

**Kaluste on vakiona varustettu EcoSmart®** (virtauksenrajoittimella)

|                                 |               |
|---------------------------------|---------------|
| Käyttöpaine:                    | maks. 1 MPa   |
| Suosittelut käyttöpaine:        | 0,1 – 0,5 MPa |
| Koestuspaine:                   | 1,6 MPa       |
| (1 MPa = 10 bar = 147 PSI)      |               |
| Kuuman veden lämpötila:         | maks. 80 °C   |
| Kuuman veden suosituslämpötila: | 65 °C         |

Hansgrohe kalusteita voi käyttää hydraulisesti tai termisesti ohjattujen läpivirtauskuumentimien yhteydessä, jos virtauspaine on vähintään 0,15 MPa.

## Merkin kuvaus



Yksivipuinen sekoittaja lämpimän veden rajoituksella, katso säätö sivulta 33. Lämpimän veden rajoitusta ei tarvita läpivirtauskuumentimen yhteydessä.



Älä käytä etikkahappopitoista silikonial!



**Mitat** (katso sivu 34 + 35)



**Virtausdiagrammi**  
(katso sivu 34 + 35)

- ① sisältää EcoSmart®
- ② ilman EcoSmart®



**Varaosat** (katso sivu 37)



**Eriyisvaruste**

Asennusavain (58085000) ei kuulu toimitukseen



Asennussarja ei kuulu toimitukseen



**Käyttö** (katso sivu 36)



**Puhdistus** (katso oheinen esite)



**Koestusmerkki** (katso sivu 38)





**Asennus katso sivu 31 + 32**





## Säkerhetsanvisningar

-  Handskar ska bäras under monteringsarbetet så att man kan undvika kläm- och skärskadorgen werden.
-  Produkten får bara användas till kroppshygien med bad och dusch.
-  Stora tryckskillnader mellan anslutningarna för varmt och kallt vatten måste utjämnas.

## Monteringsanvisningar

- Armaturen måste installeras, genomspolas och testas enligt gällande föreskrifter.
- Om det är problem med vattenberedaren eller om större vattenflöde önskas kan EcoSmart® (flödeskontroll) som sitter bakom perlatorn tas bort.

## Tekniska data

**Blandare seriemässig med EcoSmart®** (flödeskontroll)

|  |               |
|--|---------------|
| Driftstryck:   | max. 1 MPa    |
| Rek. driftstryck:                                      | 0,1 - 0,5 MPa |
| Tryck vid provtryckning:<br>(1 MPa = 10 bar = 147 PSI) | 1,6 MPa       |
| Varmvattentemperatur:                                  | max. 80 °C    |
| Rek. varmvattentemp.:                                  | 65 °C         |

Hansgrohe blandare kan användas tillsammans med hydrauliskt och termiskt styrda varmvattenberedare när flödestrycket uppgår till minst 0,15 MPa.

## Simbolio aprašymas



Enhandsblandare med varmvattenreglering, justering se sidan 33. Vid användning tillsammans med varmvattenberedare behövs ingen varmvattenreglering.



Använd inte silikon som innehåller ättiksyra!



**Måtten** (se sidan 34 + 35)



**Pralaidumo diagrama**  
(se sidan 34 + 35)

- ① med EcoSmart®
- ② utan EcoSmart®



**Reservdelar** (se sidan 37)



**Specialtillbehör**

Monteringsnyckel (58085000) medföljer ej leveransen



Installationskitet medföljer ej leveransen



**Hantering** (se sidan 36)



**Rengöring** (se den medföljande broschyren)





**Testsgill** (se sidan 38)



**Montering se sidan 31 + 32**



## Saugumo technikos nurodymai

-  Apsaugai nuo užspaudimo ir įsijovimo montavimo metu mūvėkite pirštines.
-  Gaminy s turi būti naudojamas tik maudymuisi, kūno higienai ir švarai palaikyti.
-  Turi būti išlyginti šalto ir karšto slėgio nelygumai.

## Montavimo instrukcija

- Maišytuvą privalo būti montuojamas ir išbandomas pagal veikiančias normas ir šią instrukciją.
- Jei yra problemų su momentiniu vandens šildytuvu ar neužtenka vandens srauto, galima pašalinti už aeratoriaus esantį „EcoSmart®“ (vandens srauto ribotuvą).

## Techniniai duomenys

**Šios serijos maišytuvai turi EcoSmart®** (vandens srauto ribotuvą)

Darbinis slėgis: ne daugiau kaip 1 MPa

Rekomenduojamas slėgis: 0,1 – 0,5 MPa

Bandomasis slėgis: 1,6 MPa

(1 MPa = 10 barų = 147 PSI)

Karšto vandens temperatūra: ne daugiau kaip 80 °C

Rekomenduojama karšto vandens temperatūra: 65 °C

„Hansgrohe“ maišytuvai gali būti naudojami su hidrauliškai ir termiškai reguliuojamais momentiniais šildikliais, kai vandens slėgis mažesnis kaip 0,15 MPa.

## Simbolio aprašymas



Vienos rankenėlės maišytuvai turi karšto vandens ribotuvą (nustatymą žr. psl. 33). Naudojant momentinį šildiklį karšto vandens ribotuvą nebūtina.



Nenaudokite silikono, kurio sudėtyje yra acto rūgšties!



**Išmatavimai** (žr. psl. 34 + 35)



**Pralaidumo diagrama**  
(žr. psl. 34 + 35)

- ① su EcoSmart®
- ② be EcoSmart®



**Atsarginės dalys** (žr. psl. 37)



**Specialūs priedai**

Montavimo raktas (58085000) nėra pridedama



Montavimo rinkinys nėra pridedama



**Eksplotacija** (žr. psl. 36)



**Valymas** (žr. pridedamoje brošiūroje)





**Bandymo pažyma** (žr. psl. 38)





## Sigurnosne upute

-  Prilikom montaže se radi sprječavanja prignječenja i posjekotina moraju nositi rukavice.
-  Proizvod se smije primjenjivati samo za kupanje, tuširanje i osobnu higijenu.
-  Velika razlika u pritisku između vruće i hladne vode mora biti izbalansirana.

## Upute za montažu

- Cijevi moraju biti postavljene, isprane i testirane prema važećim normama.
- Ako dolazi do problema s protočnim bojlerom ili se želi veći protok vode, može se ukloniti EcoSmart® (limitator protoka) lociran iza aeratora.

## Tehnički podaci

### Armatura ima serijski ugrađen EcoSmart®

(limitator protoka)

|                                     |               |
|-------------------------------------|---------------|
| Najveći dopušteni tlak:             | tlak 1 MPa    |
| Preporučeni tlak:                   | 0,1 – 0,5 MPa |
| Probni tlak:                        | 1,6 MPa       |
| (1 MPa = 10 bar = 147 PSI)          |               |
| Temperatura vruće vode:             | tlak 80 °C    |
| Preporučena temperatura vruće vode: | 65 °C         |

Hansgrohe armature mogu se koristiti u kombinaciji sa hidraulički i termički kontroliranim protočnim bojlerima ukoliko tlak iznosi najmanje 0,15 MPa

## Opis simbola



Da bi podesili limiter vruće vode na jednoručnim slavinama molimo Vas da pogledate stranicu 33. Podešavanje nije potrebno ako koristite protočni bojler.



Nemojte koristiti silikon koji sadrži octenu kiselinu!



**Mjere** (pogledaj stranicu 34 + 35)



**Dijagram protoka**  
(pogledaj stranicu 34 + 35)

- ① s limitatorom EcoSmart®
- ② bez limitatora EcoSmart®



**Rezervni dijelovi** (pogledaj stranicu 37)



**Posebni pribor**

ključ za montažu (58085000) Nije sadržano u isporuci!



Instalaterski kit Nije sadržano u isporuci!



**Upotreba** (pogledaj stranicu 36)



**Čišćenje** (se u priloženoj brošuri)



**Oznaka testiranja** (pogledaj stranicu 38)





## ! Güvenlik uyarıları

- ⚠ Montaj esnasında ezilme ve kesilme gibi yaralanmaları önlemek için eldiven kullanılmalıdır.
- ⚠ Duş sistemi yalnızca banyo, hijyen ve beden temizliği amaçları doğrultusunda kullanılabilir.
- ⚠ Sıcak ve soğuk su bağlantıları arasında büyük basınç farklılıkları varsa, bu basınç farklılıklarının dengelenmesi gerekir.

## Montaj açıklamaları

- Batarya monte edilmeli, geçerli normlardan sonra akis testi yapılmalıdır.
- Sürekli akışlı su ısıtıcıları ile birlikte kullanımında problemler söz konusu ise veya akan su miktarının daha fazla olması isteniyorsa, perlatörün arka tarafındaki EcoSmart® (akış sınırlayıcısı) sökülüp çıkarılabilir.

## Teknik bilgiler

### Batarya EcoSmart® (akış sınırlayıcısı) ile birlikte seri olarak

|                                 |               |
|---------------------------------|---------------|
| İşletme basıncı:                | azami 1 MPa   |
| Tavsiye edilen işletme basıncı: | 0,1 - 0,5 MPa |
| Kontrol basıncı:                | 1,6 MPa       |
| (1 MPa = 10 bar = 147 PSI)      |               |
| Sıcak su sıcaklığı:             | azami 80 °C   |
| Tavsiye edilen su ısısı:        | 65 °C         |

Hansgrohe bataryaları, akış basıncı en az 0,15 MPa olursa hidrolik ve termik kumandalı şofbenlerle bağlantılı olarak kullanılabilir.

## Simge açıklaması



Sıcak su sınırlayıcı özelliğine sahip tek kollu bataryanın ayarlanması için 33. sayfaya bakınız. Bir sürekli akışlı su ısıtıcısı ile birlikte kullanılırsa sıcak su sınırlayıcısına gerek kalmaz.



Asetik asit içeren silikon kullanmayın!



**Ölçüleri** (Bakınız sayfa 34 + 35)



**Akış diyagramı**  
(Bakınız sayfa 34 + 35)

- ① EcoSmart® dahil
- ② EcoSmart® hariç



**Yedek Parçalar** (Bakınız sayfa 37)



**Özel aksesuarlar**

Montaj anahtarı (58085000) Teslimat kapsamına dahil değildir



Montaj silikonu Teslimat kapsamına dahil değildir



**Kullanımı** (Bakınız sayfa 36)



**Temizleme** (birlikte verilen broşür)





**Kontrol işareti** (Bakınız sayfa 38)



**Montajı Bakınız sayfa 31 + 32**



## Instrucțiuni de siguranță

-  La montare utilizați mănuși pentru evitarea contuziunilor și tăierii mâinilor.
-  Sistemul de duș poate fi utilizat doar pentru spălarea, menținerea igienei și curățarea corpului.
-  Diferențele de presiune mari între alimentarea cu apă rece și apă caldă trebuie echilibrate.

## Instrucțiuni de montare

- Bateria trebuie montată, clătită și verificată conform normelor în vigoare.
- Dacă apar probleme cu boilerul instant sau dacă doriți un debit de apă mai mare, puteți să demontați unitatea EcoSmart® (limitatorul de debit), care se află în spatele suflătorului de aer.

## Date tehnice

**Bateria este dotată în serie cu EcoSmart®** (limitator de debit)

|                                       |               |
|---------------------------------------|---------------|
| Presiune de funcționare:              | max. 1 MPa    |
| Presiune de funcționare recomandată:  | 0,1 – 0,5 MPa |
| Presiune de verificare:               | 1,6 MPa       |
| (1 MPa = 10 bar = 147 PSI)            |               |
| Temperatura apei calde:               | max. 80 °C    |
| Temperatura recomandată a apei calde: | 65 °C         |

Bateriile Hansgrohe pot fi utilizate cu boiler instant cu comandă termică sau hidraulică dacă presiunea apei de alimentare este de min. 0,15 MPa.

## Descrierea simbolurilor



Bateria monocomadă cu limitarea apei calde, pentru reglare vezi pag. 33. Dacă conectați bateria la un boiler instant nu este necesară instalarea unui opritor de apă caldă.



Nu utilizați silicon cu conținut de acid acetic!



**Dimensiuni** (vezi pag. 34 + 35)



**Diagrama de debit**  
(vezi pag. 34 + 35)

- ① cu EcoSmart®
- ② fără EcoSmart®



**Piese de schimb** (vezi pag. 37)



**Accesorii opționale**

Cheie pentru montare (58085000) nu este inclus în setul livrat



Chit de instalare nu este inclus în setul livrat



**Utilizare** (vezi pag. 36)



**Curățare** (vezi broșura alăturată)





**Certificat de testare** (vezi pag. 38)



**Montare vezi pag. 31 + 32**



## Υποδειξεις ασφαλείας

-  Για να αποφύγετε τραυματισμούς κατά τη συναρμολόγηση πρέπει να φοράτε γάντια.
-  Το προϊόν επιτρέπεται να χρησιμοποιείται μόνο σαν μέσο λουτρού, υγιεινής και καθαρισμού του σώματος.
-  Οι διαφορές της πίεσης μεταξύ της σύνδεσης κρύου και ζεστού νερού θα πρέπει να αντισταθμίζονται.

## Οδηγίες συναρμολόγησης

- Η μπαταρία πρέπει να τοποθετηθεί, να πλυθεί και να ελεγχθεί με βάση τους ισχύοντες κανόνες υδραυλικής τέχνης
- Εάν παρουσιαστεί πρόβλημα με τον ταχυθερμοσίφωνα ή όταν απαιτείται περισσότερο νερό, μπορεί να απομακρυνθεί ο EcoSmart® (μειωτής ροής), ο οποίος βρίσκεται πίσω από το φίλτρο του ρουζουνιού.

## Τεχνικά Χαρακτηριστικά

### Μπαταρία μόνιμα εξοπλισμένη με EcoSmart®

(μειωτής ροής)

Λειτουργία πίεσης:

έως 1 MPa

Συνιστώμενη λειτουργία πίεσης:

0,1 - 0,5 MPa

Πίεση ελέγχου:

1,6 MPa

(1 MPa = 10 bar = 147 PSI)

Θερμοκρασία ζεστού νερού:

έως 80 °C

Συνιστώμενη θερμοκρασία ζεστού νερού:

65 °C

Οι βάνες Hansgrohe μπορούν να συνδυαστούν με ταχυθερμοσίφωνες υδραυλικού και θερμικού ελέγχου, όταν η πίεση ροής αριθμεί τουλάχιστον 0,15 MPa.

## Περιγραφή συμβόλων



Για να προσαρμόσετε το δοσομετρική ζεστού νερού σε αναμεικτικές μπαταρίες, παρακαλούμε δείτε τη ρύθμιση στη σελ. 33. Δεν είναι απαραίτητη η διάταξη φραγής ζεστού νερού σε συνδυασμό με ταχυθερμοσίφωνα.



Μην χρησιμοποιείτε σιλικόνη που περιέχει οξικό οξύ!



**Διαστάσεις** ( βλ. σελίδα 34 + 35 )



**Διάγραμμα ροής**  
( βλ. σελίδα 34 + 35 )

① με EcoSmart®

② χωρίς EcoSmart®



**Ανταλλακτικά** ( βλ. σελίδα 37 )



**Ειδικά αξεσουάρ**

Κλειδί συναρμολόγησης (58085000) δεν περιλαμβάνεται στον παραδοτέο εξοπλισμό



Κιτ εγκατάστασης δεν περιλαμβάνεται στον παραδοτέο εξοπλισμό



**Χειρισμός** ( βλ. σελίδα 36 )



**Καθαρισμός** ( βλ. συνημμένο φυλλάδιο )





**Σήμα ελέγχου** ( βλ. σελίδα 38 )





## Varnostna opozorila

-  Pri montaži je treba nositi rokavice, da se preprečijo poškodbe zaradi zmečkanja ali urezov.
-  Ta izdelek se sme uporabljati le z namenom umivanja, vzdrževanja higiene in telesne nege.
-  Velike razlike v tlaku med priključkom za mrzlo in priključkom za toplo vodo je potrebno izravnati.

## Instructions pour le montage

- Armaturo je potrebno montirati, splakniti in testirati v skladu z veljavnimi predpisi.
- Če imate probleme s pretočnim grelnikom, ali če želite večji pretok vode, lahko odstranite EcoSmart® (omejevalnik pretoka), ki se nahaja za perlatorjem.

## Tehnični podatki

### Armaturo je serijsko opremljena z EcoSmart®

(omejevalnikom pretoka)

|                                     |               |
|-------------------------------------|---------------|
| Delovni tlak:                       | maks. 1 MPa   |
| Priporočeni delovni tlak:           | 0,1 - 0,5 MPa |
| Preskusni tlak:                     | 1,6 MPa       |
| (1 MPa = 10 bar = 147 PSI)          |               |
| Temperatura tople vode:             | maks. 80 °C   |
| Priporočena temperatura tople vode: | 65 °C         |

Armaturo Hansgrohe lahko uporabljate v povezavi s hidravlično in termično uravnavanimi pretočnimi grelniki, če je pretočni tlak najmanj 0,15 MPa.

## Opis simbola



Enoročne mešalne baterije z omejevalnikom tople vode, za justiranje glejte stran 33. V povezavi s pretočnimi grelniki zapora tople vode ni potrebna.



Ne smete uporabiti silikona, ki vsebuje očetno kislino!



**Mere** (glejte stran 34 + 35)



**Diagram pretoka**  
(glejte stran 34 + 35)

- ① z omejevalnikom pretoka EcoSmart®
- ② brez omejevalnika pretoka EcoSmart®



**Rezervni deli** (glejte stran 37)



**Poseben pribor**

Montažni ključ (58085000) Ni vključeno



Komplet za montažo Ni vključeno



**Upravljanje** (glejte stran 36)



**Čiščenje** (glejte priloženi brošuri)



**Preskusni znak** (glejte stran 38)



**Montaža Glejte stran 31 + 32.**



## Ohutusjuhised

- ⚠ Kandke paigaldamisel muljumis- ja löikevigastuste vältimiseks kindaid.
- ⚠ Toodet tohib kasutada ainult pesemis-, hügieeni- ja kehahupastamiseesmärkidel.
- ⚠ Kui külma ja kuuma vee ühenduste surve on väga erinev, tuleb need tasakaalustada.

## Paigaldamisjuhised

- Seadmestiku paigaldamine, läbipesu ja kontrollimine peab toimuma vastavalt kehtivatele normidele.
- Kui esineb probleeme läbivooluboileiga või kui soovitakse, et vee läbivool oleks suurem, tuleks sõela taga asuv EcoSmart® (veehulgapiiraja) eemaldada.

## Tehnilised andmed

**Segistisari on toodetud koos EcoSmart®** (veehulgapiirajaga)

Töörõhk maks. 1 MPa

Soovitav töörõhk: 0,1 – 0,5 MPa

Kontrollsurve: 1,6 MPa

(1 MPa = 10 baari = 147 PSI)

Kuuma vee temperatuur: maks. 80 °C

Soovitav kuuma vee temperatuur: 65 °C

Hansgrohe segisteid võib kasutada koos hüdrauliliselt ja termiliselt juhivate boileritega, kui vee surve on vähemalt 0,15 MPa.

## Sümbolite kirjeldus



Ühe juhtkangiga segisti kuuma vee piiraja reguleerimise kohta vt lk 33. Läbivoolu boilerite puhul pole reguleerimine vajalik.



Ärge kasutage äädikhapet sisaldavat silikooni!



**Mõõtude** (vt lk 34 + 35)



**Läbivooludiagramm**  
(vt lk 34 + 35)

- ① EcoSmart® olemas
- ② EcoSmart® puudub



**Varuosad** (vt lk 37)



**Spetsiaalne lisavarustus**

Montaaživõti (58085000) ei sisaldu komplektis



Paigalduskomplekt ei sisaldu komplektis



**Kasutamine** (vt lk 36)



**Puhastamine** (vt kaasasolevast brošüürist)





**Kontrollsertifikaat** (vt lk 38)







## Drošības norādes

-  Montāžas laikā, lai izvairītos no saspiedumiem un iegriezumiem, nepieciešams nēsāt cimdus.
-  Šo produktu drīkst izmantot tikai, lai mazgātos, higiēnai un ķermeņa tīrīšanai.
-  Jāizlīdzina spiediena atšķirības starp aukstā un karstā ūdens pievadiem.

## Norādījumi montāžai

- Jaucējkrāns jāmontē, jāskalo un jāpārbauda atbilstoši spēkā esošajām normām.
- Ja rodas problēmas ar caurtes sildītāju vai ja ūdens plūsma nav pietiekami spēcīga, EcoSmart® (caurtes ierobežotāju), kas atrodas aiz aeratora, drīkst noņemt.

## Tehniskie dati

### Jaucējkrāns tiek ražots kopā ar EcoSmart®

(caurtes ierobežotāju)

|                                     |               |
|-------------------------------------|---------------|
| Darba spiediens:                    | maks. 1 MPa   |
| leteicamais darba spiediens:        | 0,1 - 0,5 MPa |
| Pārbaudes spiediens:                | 1,6 MPa       |
| (1 MPa = 10 bar = 147 PSI)          |               |
| Karstā ūdens temperatūra:           | maks. 80 °C   |
| leteicamā karstā ūdens temperatūra: | 65 °C         |

Hansgrohe jaucējkrānus var izmantot kombinācijā ar hidrauliski un termiski vadāmiem caurtes sildītājiem, ja plūsmas spiediens ir vismaz 0,15 MPa.

## Simbolu nozīme



Viensvirs jaucējkrāns ar siltā ūdens ierobežošanu, ieregulēšanu skat. 33. lpp. Kombinācijā ar caurtes sildītāju karstā ūdens ierobežošana nav nepieciešama.



Neizmantot silikonu, kas satur etiķskābi!



**Izmērus** (skat. 34 + 35. lpp.)



**Caurplūdes diagramma**  
(skat. 34 + 35. lpp.)

- ① ar EcoSmart®
- ② bez EcoSmart®



**Rezerves daļas** (skat. 37. lpp.)



**Speciāli aksesuāri**

Montāžas atslēga (58085000) komplektā netiek piegādāts



Instalācijas piederumi komplektā netiek piegādāts



**Lietošana** (skat. 36. lpp.)



**Tīrīšana** (skatiet pievienotajā brošūrā)





**Pārbaudes zīme** (skat. 38. lpp.)





## Sigurnosne napomene

-  Prilikom montaže se radi sprečavanja prignječenja i posekotina moraju nositi rukavice.
-  Proizvod sme da se koristi samo za kupanje, tuširanje i ličnu higijenu.
-  Velika razlika u pritisku između vruće i hladne vode mora biti izbalansirana.

## Instrukcije za montažu

- Armatura mora biti postavljena, isprana i testirana prema važećim normama.
- Ukoliko se pojave problemi sa protočnim bojlerom ili se želi veći protok vode, onda EcoSmart® (ograničavač protoka vode), koji je smešten iza aeratora, može da se ukloni.

## Tehnički podaci

### Ove armature imaju serijski ugrađen EcoSmart® (ograničavač protoka vode)

|                                     |               |
|-------------------------------------|---------------|
| Radni pritisak:                     | maks. 1 MPa   |
| Preporučeni radni pritisak:         | 0,1 – 0,5 MPa |
| Probni pritisak:                    | 1,6 MPa       |
| (1 MPa = 10 bar = 147 PSI)          |               |
| Temperatura vruće vode:             | maks. 80 °C   |
| Preporučena temperatura vruće vode: | 65 °C         |

Hansgrohe armature se mogu koristiti u kombinaciji s hidraulički i termički kontrolisanim protočnim bojlerima ukoliko pritisak iznosi najmanje 0,15 MPa.

## Opis simbola



Da bi ste podesili ograničavač vruće vode na jednoručnim mešačima, molimo Vas da pogledate stranicu 33. Podešavanje nije potrebno ako koristite protočni bojler.



Nemojte koristiti silikon koji sadrži sircetnu kiselinu!



**Mere** (vidi stranu 34 + 35)



**Dijagram protoka**  
(vidi stranu 34 + 35)

- ① sa ograničavačem EcoSmart®
- ② bez ograničavača EcoSmart®



**Rezervni delovi** (vidi stranu 37)



**Poseban pribor**

ključ za montažu (58085000) Nije sadržano u isporuci



Instalaterski komplet Nije sadržano u isporuci



**Rukovanje** (vidi stranu 36)



**Čišćenje** (vidi priloženoj brošuri)





**Ispitni znak** (vidi stranu 38)





## Sikkerhetshenvisninger

-  Bruk hansker under montasjen for å unngå klem- og kuttskader.
-  Dusjsystemet skal kun brukes for bade-, hygiene- og kroppshygiene.
-  Store trykkdifferanser mellom kaldt- og varmtvannstilkoblinger skal utlignes.

## Montagehenvisninger

- Armaturen skal monteres, spyles og sjekkes iht. gyldige standarder.
- Ved problemer med gjennomstrømningssovnen, eller når man ønsker en større vanngjennomstrømning, kan EcoSmart® (gjennomstrømningsbegrenser) fjernes. Den sitter bak luftdysene.

## Tekniske data

### Armatur er standardmessig utstyrt med EcoSmart® (gjennomstrømningsbegrenser)

|                                    |               |
|------------------------------------|---------------|
| Driftstrykk                        | maks. 1 MPa   |
| Anbefalt driftstrykk:              | 0,1 – 0,5 MPa |
| Prøvetrykk                         | 1,6 MPa       |
| (1 MPa = 10 bar = 147 PSI)         |               |
| Varmtvannstemperatur               | maks. 80 °C   |
| Anbefalt temperatur for varmt vann | 65 °C         |

Armaturer fra Hansgrohe kan brukes sammen med hydraulisk og termisk strypte gjennomstrømningssovner når gjennomstrømningstrykket er på minst 0,15 MPa.

## Symbolbeskrivelse



Enhåndblande batteri med varmtvannsbegrensning. For justering se side 33. I forbindelse med en gjennomstrømningssovn er det ikke nødvendig med varmtvannsbegrensning.



Ikke bruk silikon som inneholder eddiksyre!



**Mål** (se side 34 + 35)



**Gjennomstrømningsdiagram**  
(se side 34 + 35)

- ① med EcoSmart®
- ② uten EcoSmart®



**Service deler** (se side 37)



**Ekstratilbehør**

Montasjenøkkel (58085000) ikke med i leveransen



Installasjonskitt ikke med i leveransen



**Betjening** (se side 36)



**Rengjøring** (se vedlagt brosjyre)





**Prøvemerke** (se side 38)



**Montasje se side 31 + 32**



## **Указания за безопасност**

-  При монтажа трябва да се носят ръкавици, за да се избегнат наранявания поради притискане или порязване.
-  Позволено е използването на продукта само за къпане, хигиена и цели на почистване на тялото.
-  Големите разлики в налягането между изводите за студената и топлата вода трябва да се изравняват.

## **Указания за монтаж**

- Арматурата трябва да се монтира, промие и провери в съответствие с валидните норми.
- При проблеми с проточния нагревател или когато желаете по-голяма пропускателна способност на водата, може да отстраните EcoSmart® (ограничителя на протичане), който се намира зад аератора.

## **Технически данни**

### **Арматурата е оборудвана серийно с EcoSmart® (ограничител на протичане)**

|  |               |
|--|---------------|
| Работно налягане:                            | макс. 1 МПа   |
| Препоръчително работно налягане:             | 0,1 – 0,5 МПа |
| Контролно налягане:                          | 1,6 МПа       |
| (1 МПа = 10 bar = 147 PSI)                   |               |
| Температура на горещата вода:                | макс. 80 °C   |
| Препоръчителна температура на горещата вода: | 65 °C         |

Арматурите на Hansgrohe могат да се използват във връзка с хидравлично и термично управляеми проточни нагреватели, ако хидравличното налягане е минимум 0,15 МПа.

## **Описание на символите**



Смесител с една ръкохватка с ограничител за топлата вода, юстирането вижте на стр. 33. Във връзка с проточни нагреватели не е необходима блокировка за топлата вода.



Не използвайте силикон, съдържащ оцетна киселина!



**Размери** (вижте стр. 34 + 35)



**Диаграма на потока**  
(вижте стр. 34 + 35)

- ① с EcoSmart®
- ② без EcoSmart®



**Сервизни части** (вижте стр. 37)



**Специални принадлежности**

Монтажен ключ (58085000) не се съдържа в обема на доставка



Инсталационен кит не се съдържа в обема на доставка



**Обслужване** (вижте стр. 36)



**Почистване** (от приложената брошура)



**Контролен знак** (вижте стр. 38)



**Монтаж вижте стр. 31 + 32**



## Udhëzime sigurie

- ⚠ Për të evituar lëndimet e pickimeve ose të prerjeve gjatë procesit të montimit duhet që të vishni doreza.
- ⚠ Produkti duhet të përdoret vetëm qëllimet e banjave, të higjienës dhe të larjes së trupit.
- ⚠ Ndryshimet e mëdha të presionit mes lidhjeve të ujit të ftohtë dhe atij të ngrohtë duhen ekuilibruar.

## Udhëzime për montimin

- Armatura duhet montuar, shpërlarë dhe kontrolluar në bazë të normave të vlefshme.
- Nëse lindin probleme me ngrohësin e ujit ose nëse dëshironi të keni më shumë qarkullim uji, atëherë EcoSmart® (kufizuesi i qarkullimit të ujit), i cili ndodhet pas ajrosësit, mund të çmontohet.

## Të dhëna teknike

### Rubineti është i pajisur si standard me EcoSmart® (Kufizues qarkullimi)

|  |               |
|--|---------------|
| Presioni gjatë punës                         | maks. 1 MPa   |
| Presioni i rekomanduar:                      | 0,1 – 0,5 MPa |
| Presioni për provë:                          | 1,6 MPa       |
| (1 MPa = 10 bar = 147 PSI)                   |               |
| Temperatura e ujit të ngrohtë                | maks. 80 °C   |
| Temperatura e rekomanduar e ujit të ngrohtë: | 65 °C         |

Armaturat e Hansgrohe mund të përdoren në kombinim me ngrohës elektrikë të ujit të drejtuar në mënyrë hidraulike ose termike nëse presioni i rrjedhjes është minimumi 0,15 MPa.

## Përshkrimi i simbolit



Rubinet me ujë të përzier me kufizim të ujit të ngrohtë, justimi shih faqen 33. Në kombinim me ngrohësit elektrikë të ujit nuk ka nevojë për bllokadë të ujit të ngrohtë.



Mos përdorni silikon që në përbërje ka acid acetik.



**Përmasat** (shih faqen 34 + 35)



**Diagrami i qarkullimit** (shih faqen 34 + 35)

- ① me EcoSmart®
- ② pa EcoSmart®



**Pjesë ndërrimi** (shih faqen 37)



**Pajisje të posaçme**

Çelësi i montimit (58085000) nuk përfshihet në vëllimin e furnizimit



Stuko për instalim nuk përfshihet në vëllimin e furnizimit



**Përdorimi** (shih faqen 36)



**Pastrimi** (shikoni broshurën bashkëngjitur)



**Shenja e kontrollit** (shih faqen 38)



**Montimi shih faqen 31 + 32**



## وصف الرمز

لضبط محدد الماء الساخن في الخلاطات ذات المقبض الواحد، يرجى الرجوع إلى صفحة 33. ولا يلزم إجراء أي ضبط عند استخدام سخان مياه ذي تدفق مستمر.



هام! لا تستخدم السليكون الذي يحتوي على أحماض!



أبعاد (راجع صفحة 35 + 34)



## رسم للصرف

(راجع صفحة 35 + 34)



① بـ EcoSmart®

② بدون EcoSmart®

قطع الغيار (راجع صفحة 37)



## ملحقات خاصة

مفتاح التركيب (58085000) غير مدرج مع المحتويات المسلمة



طقم تركيب غير مدرج مع المحتويات المسلمة



التشغيل (راجع صفحة 36)



التنظيف (راجع والكتيب المرفق)



شهادة اختبار (راجع صفحة 38)



## تنبيهات الأمان



- ⚠ يجب ارتداء قفازات لليد أثناء التركيب لتجنب حدوث أضرار الإنحسار أو الجروح.
- ⚠ لا يجب استخدام نظام الدش إلا في أغراض الاستحمام والأغراض الصحية وأغراض تنظيف الجسم.
- ⚠ يجب أن يكون تيار الماء الساخن والماء البارد متعادلين في الضغط.

## تعليمات التركيب

- يجب تركيب الوصلة واستخدامها واختبارها وفقاً للمعايير المعمول بها.
- إذا تسبب سخان الماء الجاري في أية مشكلات أو في حالة الرغبة في وجود تدفق أكثر للماء، يجب فك EcoSmart® (محدد تدفق المياه) الموجود خلف تجهيزة التهوية.

## المواصفات الفنية

يتم بشكل قياسي إنتاج الخلاط هذا مع EcoSmart® (محدد تدفق المياه)

الحد الأقصى 1 ميجاباسكال

ضغط التشغيل: 0,5 – 0,1 ميجاباسكال

ضغط الاختبار: 1,6 ميجاباسكال

(1 ميجاباسكال = 10 بار = 147 PSI)

الحد الأقصى 80°C

درجة حرارة الماء الساخن: 65°C

يمكن استخدام خلاطات هانزجروهي مع سخانات تدفق الماء ذات

التحكم الهيدروليكي و الحراري، مع ضغط تدفق لا يقل عن 0,15

ميجاباسكال.



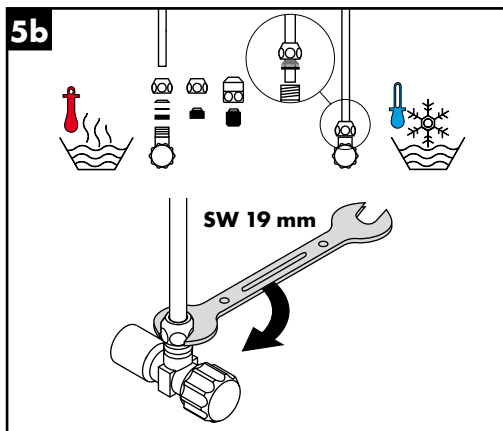
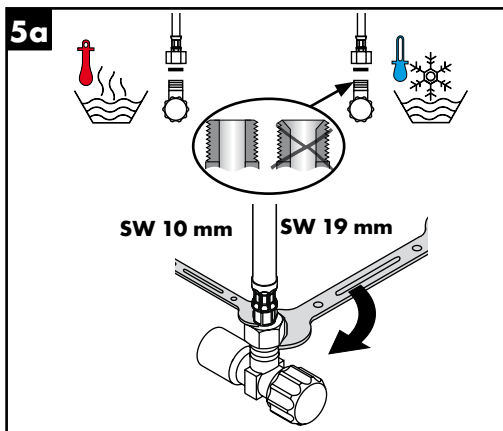
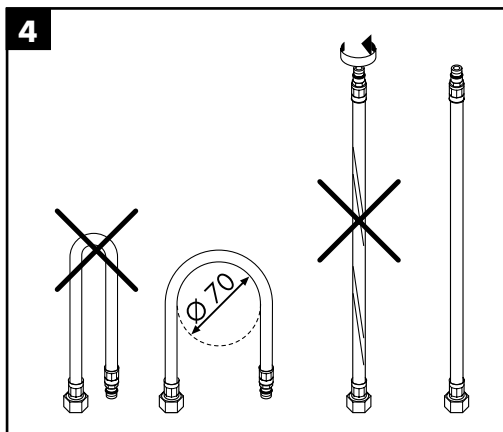
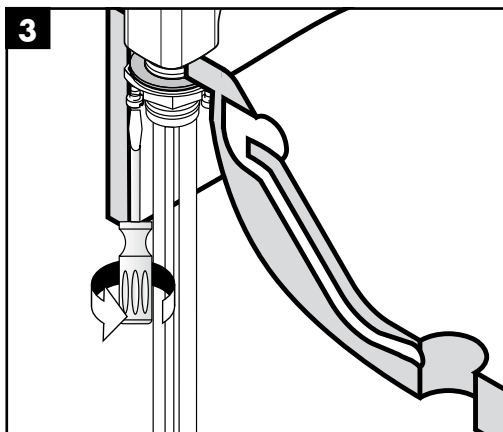
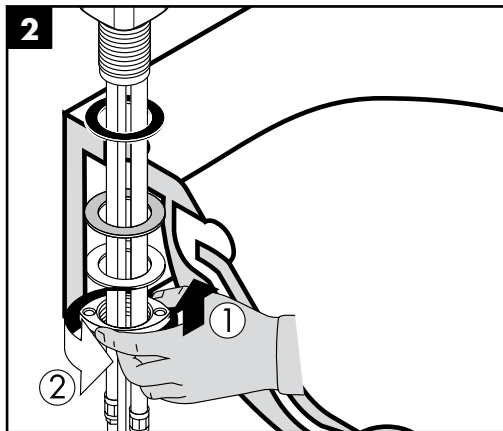
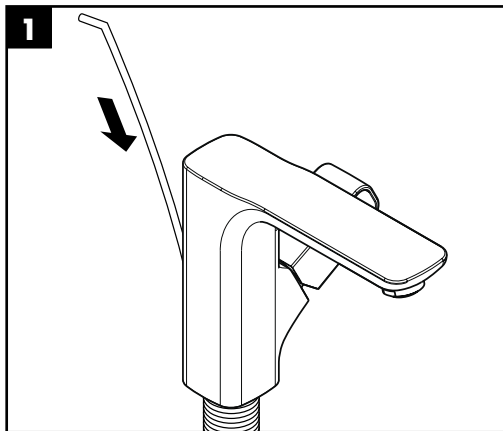

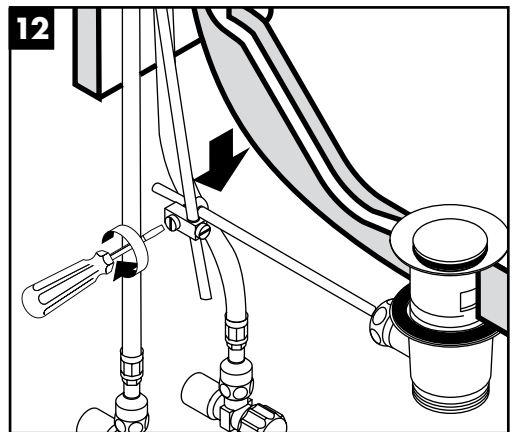
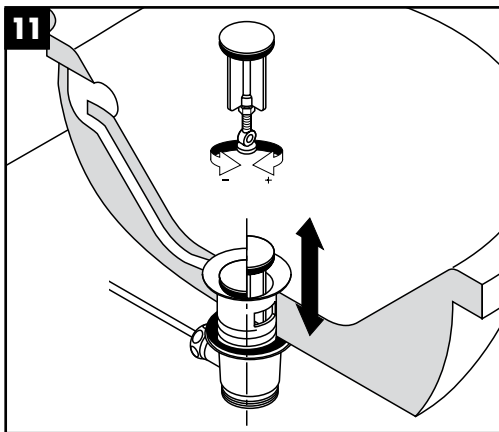
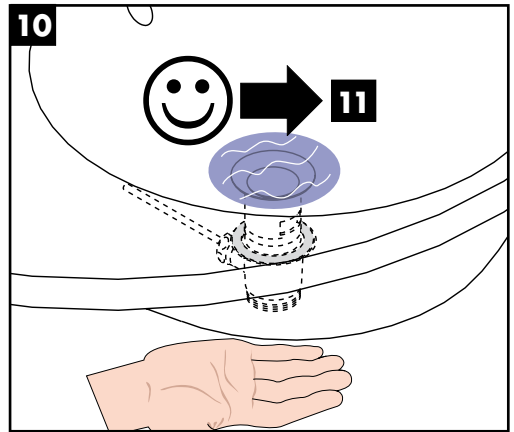
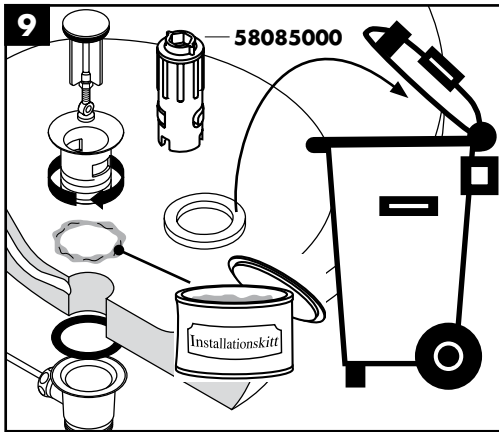
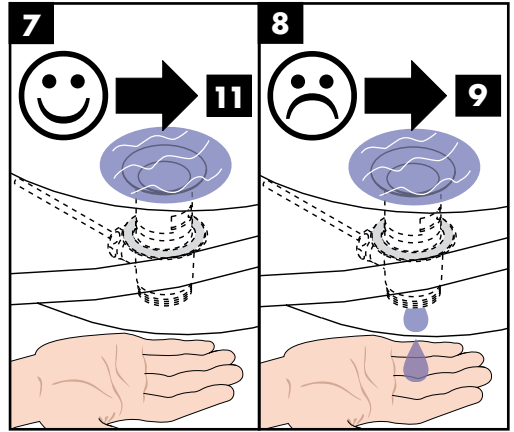
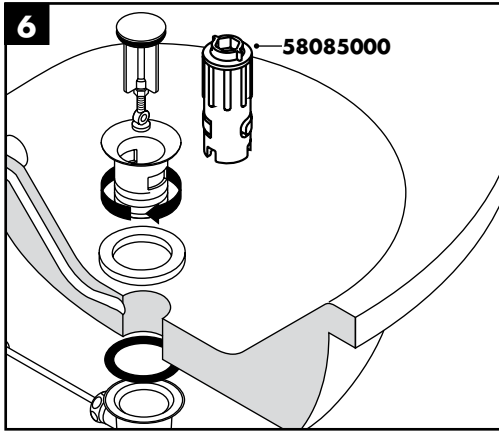



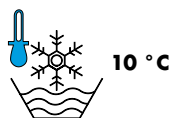

0,3 МПа  
0,3 МПа  
میجابسکال 0,3

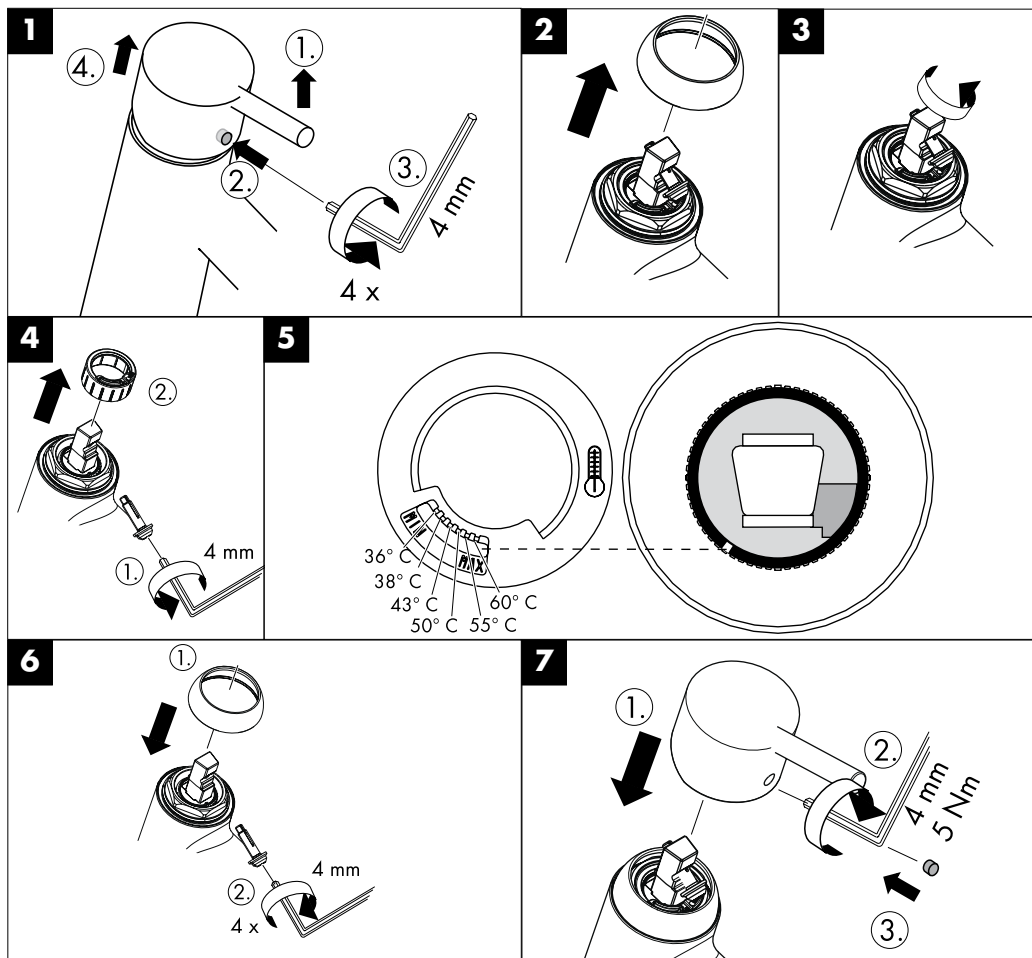



**Urquiola**  
11020000 / 11021000

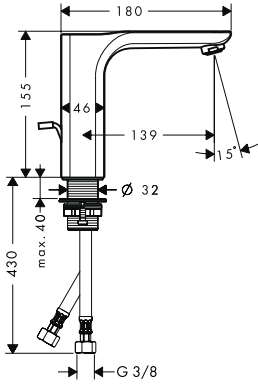

**Urquiola**  
11022000

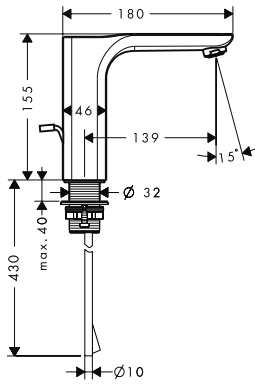

**Urquiola**  
11025000

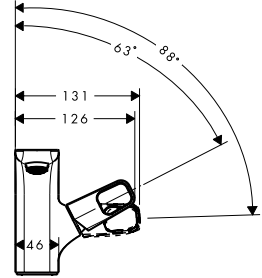
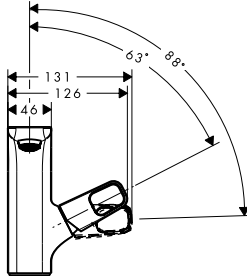
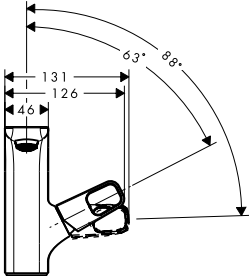
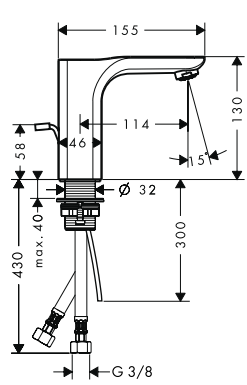

**Urquiola**  
11020000 / 11021000 / 11025000 / 11023000 / 11034000

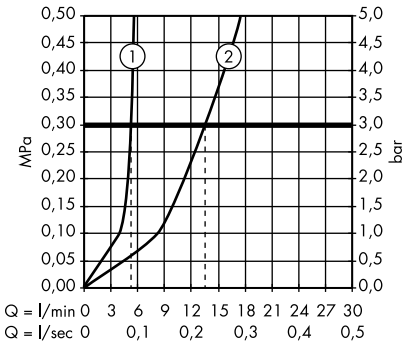

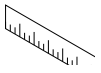

**Urquiola**  
11023000 / 11034000

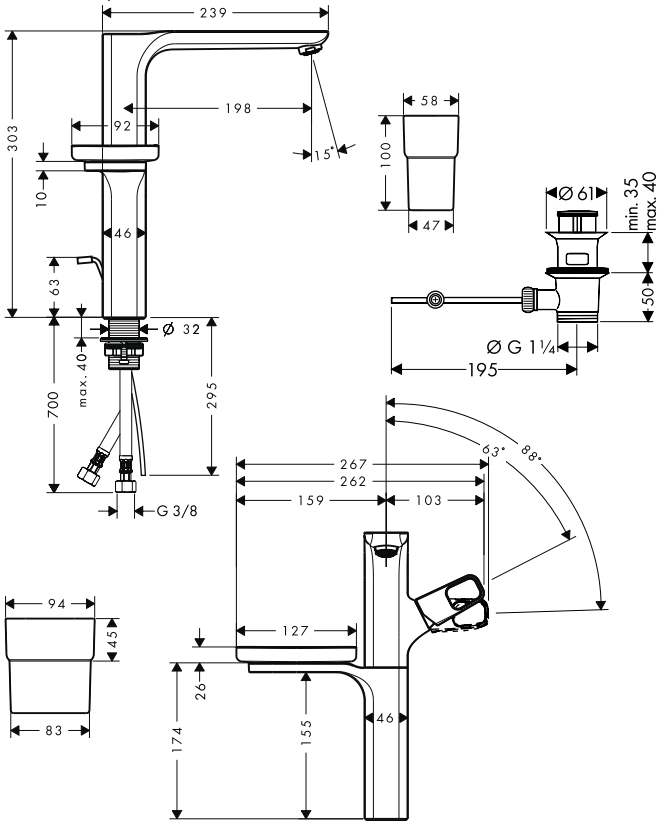

**Urquiola**  
11220000

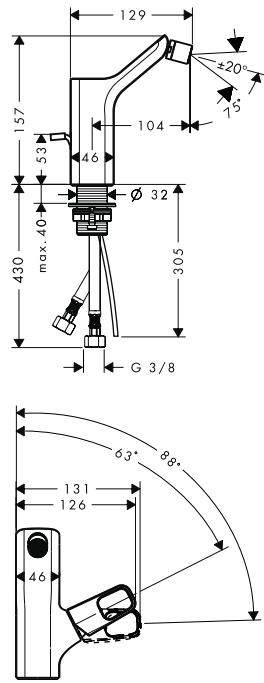

**Urquiola**  
11220000

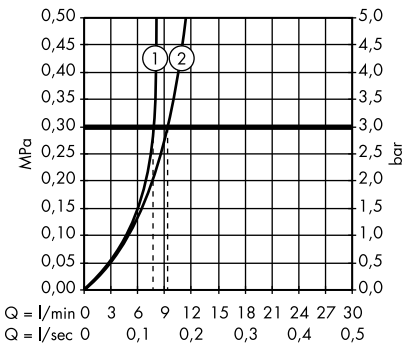

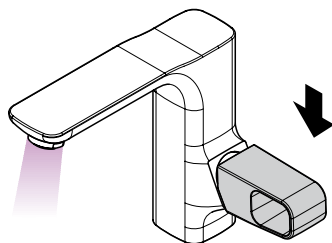

öffnen / ouvert / open / aperto / abierto / open / åbne /  
abrir / otworzyć / otevřít / otvorit / 开 / открыть / nyitás /  
avaaminen / öppna / atidaryti / Отваранье / açmak /  
deschide / ανοικτό / odpreti / avage / atvērt /  
otvoriti / åpne / отварање / hare / فتح

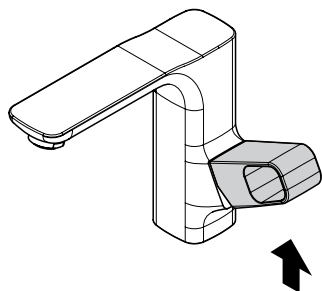

schließen / fermé / close / chiudere / cerrar / sluiten /  
lukke / fechar / zamknąć / zavřít / uzavrieť / 关 /  
закреть / bezárás / sulkeminen / stänga / uždaryti /  
Zatvaranje / kapatmak / închide / κλειστό /  
zapreti / sulgege / aizvērt / zatvori / lukke / затваряње /  
mbylle / إغلاق

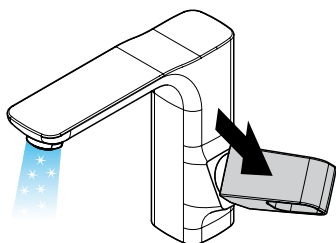

kalt / froid / cold / freddo / frío / koud / koldt / fria /  
zimna / studená / studená / 冷 / холодная / hideg /  
kylmä / kallt / šaltas / Hladno / soğuk / rece / κρύο /  
mrzlo / külm / auksts / hladno / kaldt / студено / i ftohtë /  
بارد

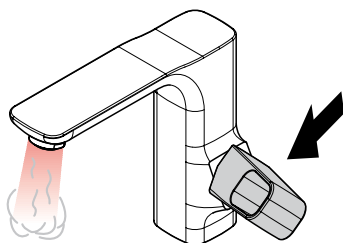

warm / chaud / hot / caldo / caliente / warm / varmt /  
quente / ciepła / teplá / teplá / 热 / горячая / meleg /  
lämmin / varmt / karštas / Vruća voda / sıcak / cald /  
ζεστό / toplo / kuum / karsts / topla / varm / тепло /  
i ngrohtë / ساخن

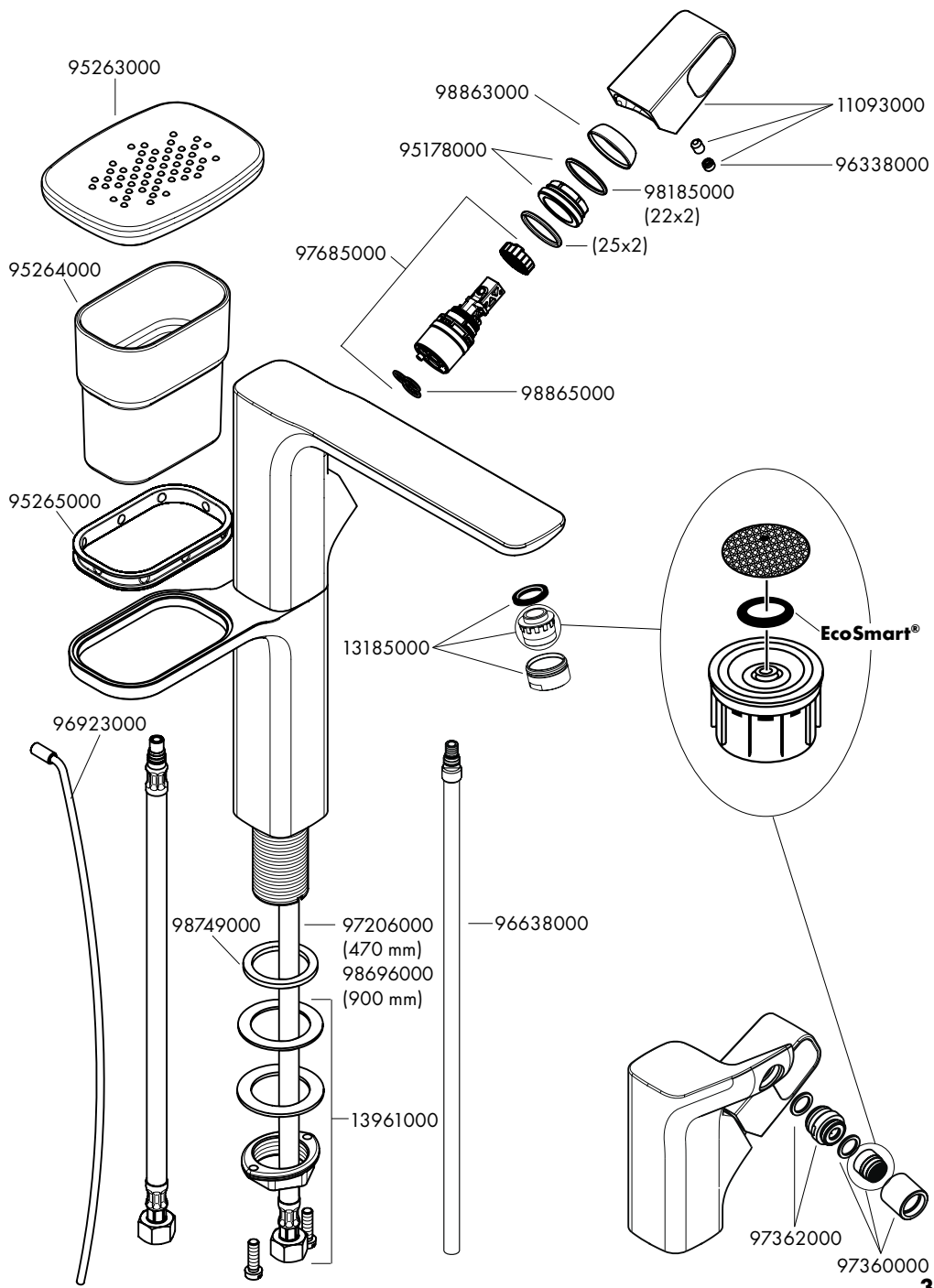



---

|                 | <b>P-IX</b>   | <b>DVGW</b> | <b>SVGW</b> | <b>WRAS</b> | <b>KIWA</b> | <b>NF</b> | <b>ACS</b> | <b>ETA</b> |
|-----------------|---------------|-------------|-------------|-------------|-------------|-----------|------------|------------|
| <b>11020000</b> | P-IX 19147/IZ |             |             |             | X           |           | X          |            |
| <b>11021000</b> | P-IX 19147/IZ |             |             |             | X           |           | X          |            |
| <b>11022000</b> | P-IX 19147/IZ |             |             |             | X           |           | X          |            |
| <b>11023000</b> | P-IX 19147/IZ |             |             |             | X           |           | X          |            |
| <b>11025000</b> | P-IX 19147/IZ |             |             |             | X           |           | X          |            |
| <b>11034000</b> | P-IX 19147/IZ |             |             |             | X           |           | X          |            |
| <b>11220000</b> | P-IX 19147/IZ |             |             |             | X           |           | X          |            |





---

**hansgrohe**

Hansgrohe - Postfach 1145 · D-77761 Schiltach · Telefon +49 (0) 78 36/51-1282 · Telefax +49 (0) 7836/511440  
E-Mail: [info@hansgrohe.com](mailto:info@hansgrohe.com) · Internet: [www.hansgrohe.com](http://www.hansgrohe.com)

08/2010  
9.04630.04